

FREEDOM

Communication Technologies

R8100 SERIES COMMUNICATIONS SYSTEM ANALYZER OPERATOR'S MANUAL



Documentation for firmware version 2.2.0.0

Freedom Communication Technologies
2002 Synergy Blvd. Suite 200
Kilgore Texas 75662 USA
Tel/Fax: +1-844-903-7333
© Freedom Communication Technologies 2017
All Rights Reserved
FCT-1366B

Printed in U.S.A.

Table of Contents

<u>Topic</u>	<u>Page</u>
LIMITED WARRANTY.....	11
SOFTWARE LICENSE AGREEMENT.....	12
1 PRE-OPERATION OVERVIEW.....	13
1.1 SCOPE OF MANUAL.....	13
1.2 SAFETY SUMMARY	13
1.2.1 Analyzer Grounding.....	13
1.2.2 Unit is Live When Plugged In or when Battery is Installed.....	13
1.2.3 Keep Away From Live Circuits.....	13
1.2.4 Explosive Atmosphere	13
1.3 WARNINGS AND CAUTIONS	13
1.3.1 Analyzer Operating Voltage.....	14
1.3.2 DC Power Source.....	14
1.3.3 Battery	14
1.3.4 Maximum Meter In Voltages.....	15
1.3.5 Replacement Fuses.....	15
1.3.6 Other Cautions.....	15
1.3.7 User Maintenance of exterior surfaces.....	15
1.4 SERVICE	15
1.5 REPLACEMENT PARTS ORDERS.....	16
1.6 INSTALLATION.....	16
1.6.1 Packing.....	16
1.6.2 Initial Set-up.....	16
1.6.3 Warm-up.....	16
1.7 Description.....	16
1.8 Technical Specifications	20
1.8.1 AC Adapter Specifications	20
1.8.2 Port Specifications.....	20
1.8.3 Mechanical Specifications.....	20
1.8.4 Battery Specifications.....	20
1.9 Operator Interface and Controls.....	21
1.9.1 Front Panel Control Keys	22

	1.9.2	Front Panel Control Knobs	25
	1.9.3	Front Panel Display and Indicators	26
2		OPERATION	30
	2.1	Overview.....	30
	2.1.1	Basic navigation and operator control.....	30
	2.1.2	Hot keys for fast navigation in Monitor, Audio, Display and Meter zones.....	33
	2.2	Operating Instructions.....	34
	2.2.1	RF Zone / Monitor Mode	34
	2.2.2	RF Zone / Generate Mode.....	39
	2.2.3	RF Zone / Duplex Mode.....	41
	2.2.4	Display Zone	60
	2.2.5	Meter Zone.....	73
	2.2.6	Instrument Menu.....	81
	2.2.7	Test Menu.....	94
	2.2.8	Settings Menu.....	213
	2.2.9	Screen Capture	228
3		REMOTE OPERATION.....	230
	3.1	BIOS Power-loss Setup	231
	3.2	DHCP Server Setup	231
	3.3	Network Port Setup	232
	3.4	Computer Setup.....	233
	3.4.1	Setup.....	234
	3.4.2	Control	234
	3.5	Disable Remote Access	234
	3.6	Verification / Troubleshooting Information	235
4		TEST APPLICATIONS.....	236
	4.1	FM Transmitter Testing	236
	4.1.1	Basic FM Transmitter Testing – initial setup	236
	4.1.2	Transmit Power, Frequency, and Frequency Deviation Measurements.....	237
	4.1.3	Modulation Measurements.....	237
	4.1.4	Off-The-Air Measurements	238
	4.2	FM Receiver Testing.....	238
	4.2.1	Basic FM Receiver Testing – initial setup	238

4.2.2	Receiver Distortion Measurement	240
4.2.3	SINAD Measurement	240
4.2.4	Modulation Acceptance Bandwidth.....	240
4.2.5	Receiver Sensitivity Testing (20 dB Quieting).....	240
4.2.6	Squelch Sensitivity Test	240
4.3	Cable Fault Testing	241
4.3.1	Cable Fault Locator Setup and Operation.....	242
4.4	ITCR Interoperable Train Control Radio (Positive Train Control)	245
Appendix A – Glossary (List of Abbreviations and Acronyms)		250
Appendix B – Tone and Code Specifications		253
Appendix C – R8100 Field Calibration Procedure.....		258

List of Figures

		<u>Page</u>
Figure 2.1-1	Front Panel Controls, Indicators, and Connectors	18
Figure 2.1-2	Left and Right Sides of the R8100.....	19
Figure 3.1.1-1	Main screen in Monitor Mode showing related information in grouped display zones ..	31
Figure 3.1.1-2	Main display area after Audio Zone soft key press	32
Figure 3.1.1-4	Audio Zone data entry for Fixed 1 kHz Level.....	33
Figure 3.1.2-1	Outline around Numeric Keypad Hot Keys.....	34
Figure 3.2.1-1	RF Zone display area showing Monitor Mode data	35
Figure 3.2.1-2	Monitor Mode submenu after RF Zone soft key press	36
Figure 3.2.1-3	Data entry window before and after Monitor frequency change.....	38
Figure 3.2.1-4	RF Zone display area after Monitor frequency change.....	38
Figure 3.2.2-1	RF Zone display area showing Generator Mode data	39
Figure 3.2.2-2	Generator Mode submenu after RF Zone soft key press.....	40
Figure 3.2.3-1	RF Zone display after Duplex key press	42
Figure 3.2.4-1	Audio Zone display with the R8100 in Generate Mode	44
Figure 3.2.4-2	Audio Zone display with the R8100 in Monitor Mode.....	44
Figure 3.2.4.1-1	Audio Zone submenu in Monitor Mode.....	45
Figure 3.2.4.2-1	Format submenu in Audio Zone.....	46
Figure 3.2.4.2-2	DTMF Table providing additional code sequence control.....	48
Figure 3.2.4.3-1	PL Table showing highlighted entry code	50
Figure 3.2.4.3-2	A/B Sequence table showing highlighted sequence	51
Figure 3.2.4.3-3	A/B Sequence table submenu for user programmable entries.....	52
Figure 3.2.4.3-4	5/6 Tone entry submenu	53
Figure 3.2.4.3-5	POCSAG Table submenu.....	54
Figure 3.2.4.3-6	General Sequence Table submenu.....	56
Figure 3.2.4.4-1	Audio Zone submenu in Generator Mode.....	59
Figure 3.2.5-1	Display Zone submenu after Select Display soft key press	61
Figure 2.2.4.1-1	Trace Math Display.....	63
Figure 2.2.4.1-2	Demod At Marker submenu.....	65
Figure 2.2.4.2-1	Display Zone submenu for the Mod Scope.....	66
Figure 3.2.5.3-1	Display Zone submenu for the Oscilloscope.....	68

Figure 3.2.5.4-1	Bar Graphs screen in Display Zone	72
Figure 3.2.5.5-1	General Seq screen in Display Zone	73
Figure 3.2.6-1	Meter Zone submenu showing RF Scan meter	74
Figure 3.2.6-2	Meter Zone submenu after Select Meter soft key press	74
Figure 2.2.5.1-1	RF Power Meter screen	75
Figure 2.2.5.2-1	AC Volts display.....	75
Figure 2.2.5.2-2	DC Volts display	75
Figure 2.2.5.3-1	SINAD display.....	76
Figure 2.2.5.3-2	Internal Distortion display	76
Figure 2.2.5.4-1	PL/Period Counter screen	77
Figure 2.2.5.4-2	DPL Decode screen.....	77
Figure 2.2.5.4-3	DTMF Decode screen.....	77
Figure 2.2.5.4-4	2-Tone Decode screen	78
Figure 2.2.5.4-5	5/6-Tone Decode screen	78
Figure 2.2.5.4-6	General Sequence Decode screen.....	79
Figure 2.2.5.5-1	Frequency Counter screen.....	80
Figure 2.2.5.6-1	RF Scan display	81
Figure 3.2.7-1	Submenu after pressing Instrument Navigation key	82
Figure 2.2.6.1-1	Submenu in Spectrum Analyzer Instrument Mode.....	83
Figure 2.2.6.2-1	Dual Display Mode.....	84
Figure 2.2.6.3-1	Tracking Generator Mode.....	85
Figure 2.2.6.3-2	Normalized Spectrum Analyzer trace.....	89
Figure 2.2.6.4-1	Cable Fault Locator Mode	90
Figure 2.2.6.4-2	Frequency and Attenuation entries in the Add Cable Type submenu	93
Figure 3.2.8-1	Submenu after pressing Test Navigation key.....	94
Figure 3.2.8.1-1	Submenu after pressing Presets soft key	95
Figure 3.2.8.1-2	Data entry mode after pressing Save Configuration soft key	96
Figure 3.2.8.2-1	Test Mode submenu	97
Figure 3.2.8.3-1	DMR transmitter tests	98
Figure 3.2.8.3.1-1	Submenu after pressing DMR soft key in Generator Mode	99
Figure 3.2.8.3.1.2-1	Voice Loopback Recording	101
Figure 2.2.7.2.3.2-1	Power Profile Slot.....	103

Figure 2.2.7.2.3.2-2	Power Profile Frame with Markers	105
Figure 2.2.7.2.3.3-1	Submenu after pressing DMR soft key in Monitor Mode	106
Figure 3.2.8.3.2-1	Submenu after pressing DMR soft key in Generate Mode	107
Figure 3.2.8.3.2-2	Voice Loopback Playing	108
Figure 2.2.7.3.1-1	Main screen in Monitor Mode Voice Frame Decode	111
Figure 2.2.7.3.1-2	Main screen in Monitor Mode after pressing the PROJECT 25 soft key	112
Figure 2.2.7.3.1.2-1	Test Pattern submenu in P25 Monitor Mode	113
Figure 2.2.7.3.1.2-2	P25 Voice Recording	115
Figure 2.2.7.3.1.2-3	P25 Voice Loopback	116
Figure 2.2.7.3.1.3-1	P25 Eye Diagram selection in Display Zone	118
Figure 2.2.7.3.1.3-2	Eye Diagram with Mon Mod Type WCQPSK and Display Mode Fade Away ..	118
Figure 2.2.7.3.1.3-3	P25 Voice Frame Decode	119
Figure 2.2.7.3.1.3-4	P25 Voice Frame Decode Unit to Unit	121
Figure 2.2.7.3.1.3-5	Constellation Plot (Symbols)	122
Figure 2.2.7.3.1.3-6	Ideal Constellation	123
Figure 2.2.7.3.1.3-7	Constellation Plot (Samples / Trajectories)	124
Figure 2.2.7.3.1.3-8	Distribution Plot of 1011 Hz Tone	125
Figure 3.2.8.4.2-1	Main screen in Generate Mode after pressing the PROJECT 25 soft key	126
Figure 3.2.8.4.2-2	P25 Generate Mode test patterns	126
Figure 3.2.8.4.2-3	P25 Voice Frame Encoder submenu	128
Figure 3.2.8.5-1	Main screen after selecting P25 Trunk Test Mode	135
Figure 3.2.8.5-2	Main screen after pressing P25 Trunk soft key	136
Figure 3.2.8.5-4	P25 Trunk Band Plan submenu	138
Figure 3.2.8.5-3	P25 Trunk submenu after starting BER test after registration	141
Figure 3.2.8.6-1	Main screen in Monitor Mode after selecting NXDN™ Test Mode	143
Figure 3.2.8.6.1-1	NXDN™ Monitor Mode	146
Figure 3.2.8.6.1-2	NXDN™ Voice Recording	148
Figure 3.2.8.6.1-3	NXDN™ Eye Diagram in Display Zone	149
Figure 3.2.8.6.1-4	NXDN™ Eye Diagram with display in Fade Away Mode	150
Figure 3.2.8.6.2-1	NXDN™ Generate Mode	151
Figure 3.2.8.6.3-1	Main screen after selecting NXDN Trunk Test Mode	154
Figure 3.2.8.6.3-2	Main screen after pressing NXDN™ Trunk soft key	155

Figure 3.2.8.6.3-3	NXDN™ Trunk submenu after starting BER test.....	156
Figure 2.2.7.5.1.4-1	NXDN Eye Diagram in Display Zone.....	159
Figure 2.2.7.7-1	Main screen in Monitor Mode after selecting TETRA Test Mode.....	160
Figure 2.2.7.7-2	Submenu after pressing TETRA soft key in Monitor Mode.....	161
Figure 2.2.7.7-3	Error Vector Diagram.....	163
Figure 2.2.7.7-4	Power Profile Slot.....	164
Figure 2.2.7.7-5	Power Profile Frame with Markers.....	166
Figure 2.2.7.7-6	Mod Spec / Constellation (Symbols).....	167
Figure 2.2.7.7-7	Ideal Constellation.....	168
Figure 2.2.7.7-8	Constellation (Samples / Trajectories).....	168
Figure 2.2.7.7-9	Submenu after pressing TETRA soft key in Generate Mode.....	169
Figure 2.2.7.8-2	dPMR Monitor Mode.....	173
Figure 2.2.7.8-3	dPMR Voice Recording.....	175
Figure 2.2.7.8-4	dPMR Eye Diagram in Display Zone.....	176
Figure 2.2.7.8-5	dPMR Eye Diagram with display in Fade Away Mode.....	177
Figure 2.2.7.8-6	dPMR Generate Mode.....	178
Figure 2.2.7.9.1-1	Main screen in Monitor Mode after selecting the P25 II Test Mode.....	181
Figure 2.2.7.9.1-2	Main screen in Monitor Mode after pressing the P25 II soft key.....	182
Figure 2.2.7.9.1.2-1	Test Pattern submenu in P25 II Monitor Mode.....	183
Figure 2.2.7.9.1.3-1	HDQPSK Eye Diagram selection in Display Zone.....	185
Figure 2.2.7.9.1.3-2	Eye Diagram of HCPM and Display Mode Fade Away.....	186
Figure 2.2.7.9.1.3-3	Distribution Plot of HDQPSK 1031 Hz Tone.....	187
Figure 2.2.7.9.1.3-4	Distribution Plot of HCPM 1031 Hz Tone.....	187
Figure 2.2.7.9.1.3-5	Power Profile Frame.....	188
Figure 2.2.7.9.1.3-6	Power Profile Slot with Markers.....	190
Figure 2.2.7.9.1.4-1	HDQPSK Frequency Constellation.....	190
Figure 2.2.7.9.1.4-2	HCPM Frequency Constellation.....	191
Figure 2.2.7.9.1.4-3	P25 Phase 2 Symbol Rate Measurement.....	192
Figure 2.2.7.9.2-1	Main screen in Generate Mode after selecting the P25 II soft key.....	193
Figure 2.2.7.9.2-2	P25 II Generate Mode test patterns.....	193
Figure 2.2.7.10-1	AutoTune submenu.....	196
Figure 2.2.7.10-2	AutoTune Radio Test Setup.....	197

Figure 2.2.7.10-3	AutoTune Activity Display.....	198
Figure 2.2.7.10-4	AutoTune test in progress.....	199
Figure 2.2.7.10-5	AutoTune Test Limits submenu.....	201
Figure 2.2.7.10-6	AutoTune Test Results Submenu	202
Figure 2.2.7.10-7	AutoTune Test Preferences Submenu	203
Figure 2.2.7.11-1	AutoScript submenu with no scripts or procedures imported.....	206
Figure 2.2.7.11-2	View, Results submenu with results from a procedure execution displayed	207
Figure 2.2.7.11-3	Use Toggle Selection to enable or disable script execution.....	208
Figure 2.2.7.11-4	Use Toggle Selection to enable or disable script execution.....	210
Figure 2.2.7.11-5	Example script showing commands for finding a local FM radio station.....	211
Figure 2.2.7.11-6	Example procedure containing several scripts.....	212
Figure 3.2.9-1	Submenu after pressing Settings navigation button on R8100 front panel.....	213
Figure 3.2.9.2-1	Submenu after pressing System Settings soft key in the Settings menu	215
Figure 3.2.9.2-2	Pre-Amplifier alert when broadband measurements are active	217
Figure 3.2.9.3-1	Submenu after pressing Network Setup soft key in the Settings menu	220
Figure 3.2.9.4-1	Submenu after pressing Messages soft key in the Settings menu.....	222
Figure 3.2.9.5-1	Submenu after pressing About soft key in the Settings menu.....	223
Figure 3.2.9.5-2	Settings/About/Protocols screen.....	224
Figure 3.2.9.5-3	Settings/About/Versions screen.....	225
Figure 3.2.9.5.1-1	Alert screen as R8100 finds a valid update on a USB flash drive.....	226
Figure 3.2.9.6-1	Submenu after pressing Options soft key in the Settings menu	227
Figure 3.2.10-1	File folder location and names for R8100 Screen Captures	229
Figure 4-1	Remote Front Panel.....	230
Figure 4.3-1	Network Connection Security Alert	233
Figure 5.1.1-1	Setup for FM Transmitter testing	237
Figure 5.2.1-1	Setup for FM Receiver testing	239
Figure 5.3-1	Connections for Cable Fault testing	242
Figure 5.3.1-1	Cable Fault Instrument Display	243

List of Tables

	<u>Page</u>
Table 2.2.7.2.3.3-1 DMR Symbols.....	106
Table 2.2.7.3.1.2-1 P25 Symbols	114
Table 2.2.7.3.1.3-1 P25 Voice Frame Fields	120
Table 2.2.7.3.1.3-2 P25 Status Symbol Codes.....	120
Table 2.2.7.3.1.3-3 P25 Data Unit Identifier Values	121
Table 2.2.7.3.1.3-4 P25 Service Options.....	122
Table 2.2.7.3.1.4-1 P25 Voice Frame Fields	130
Table 2.2.7.3.1.4-2 P25 Link Control Fields for LCO=1.....	131
Table 2.2.7.3.1.4-3 P25 Link Control Fields for LCO=3.....	132
Table 3.2.8.5-1 P25 Trunk Band Plan Defaults	139
Table 2.2.7.5.1.2-1 NXDN™ Symbols	145
Table 2.2.7.8.1.2-1 dPMR Symbols.....	172
Table 2.2.7.8.1.4-1 P25 Phase 2 Logical Channels.....	180
Table 2.2.7.9.1.2-1 HDQPSK Symbols.....	184
Table B-1 Standard DTMF Tones	253
Table B-2 DTMF Frequency Coding*.....	253
Table B-3 Private-Line (PL) Codes	254
Table B-4 5/6 Tone Paging Tones.....	255
Table B-5 DPL Standard Codes	255
Table B-6 Select V Frequencies.....	256
Table B-7 POCSAG Numeric Character Set	256
Table B-8 POCSAG Alpha-numeric Character Set (7-bit ASCII)	256

Freedom Communication Technologies – R8100 Series Communications System Analyzer

LIMITED WARRANTY

Freedom Communication Technologies Test Equipment Products (herein the "product") that are manufactured by Freedom Communication Technologies are warranted by Freedom Communication Technologies (FCT) for a period of two (2) years from date of shipment against defects in material and workmanship. This express limited warranty is extended to the original purchaser (herein the "buyer") only and applies only to such defects that: (1) produce repeatable failures resulting in product lock-ups or power downs rendering the product inoperable, or (2) cause the product to perform outside of Freedom Communication Technologies-published specifications.

In the event of such a defect during the period of warranty, the buyer may return the product, transportation prepaid, to Freedom Communication Technologies, 2002 Synergy Blvd. Suite 200, Kilgore Texas 75662. The buyer must include written notice specifying the nature of the defect, proof of purchase, and evidence of the date of shipment (dated packing list or invoice). Freedom Communication Technologies, at its option, will either repair or replace the product. If Freedom Communication Technologies elects to repair a defective product by replacing a module or subassembly, Freedom Communication Technologies, at its option, may replace such defective module or subassembly with a new or reconditioned replacement. This **Limited Warranty** is not extended beyond two years from original date of shipment if Freedom Communication Technologies repairs a product. Transportation charges for the return of the product will be paid by Freedom Communication Technologies.

This **Limited Warranty** is void if FCT determines:

- (1) The product has not been operated in accordance with the procedures in the operating instructions; or
- (2) The seals on non-user serviceable components or modules are broken; or
- (3) The product has been subject to misuse, abuse, damage, accident, negligence, attempted repair or alteration.

Freedom Communication Technologies does not warrant that the product will meet buyer's requirements or that the operation of the product will be uninterrupted or error free.

No other warranties, whether express, implied or statutory, including implied warranties or merchantability or fitness for particular purpose, are granted to buyer or buyer's transferees, customers, or users of the product.

In no event shall Freedom Communication Technologies be liable for any special, incidental, or consequential damages arising from this agreement or use of the product.

SOFTWARE LICENSE AGREEMENT

PLEASE READ THIS LICENSE AGREEMENT CAREFULLY BEFORE USING THE SOFTWARE. BY USING THE SOFTWARE, YOU AGREE TO THE TERMS OF THIS LICENSE. IF YOU DO NOT AGREE, PROMPTLY RETURN THE HARDWARE AND SOFTWARE FOR A REFUND.

1. **LICENSE GRANT:** As used in this Agreement, the term "Software" means the software embedded in the unit of R8100 Series Communications System Analyzer (the "Instrument") sold by Freedom Communication Technologies Inc. ("Licensor") to you ("Licensee") either directly or through Licensor's distribution network. Subject to your acceptance of these terms, Licensor grants to Licensee a non-exclusive license to use the Software and related documentation (the "Documentation") only in connection with your use of the unit of the Instrument in which the Software is embedded.

2. **OWNERSHIP:** This is not a sale of the Software. Licensor and/or its licensors retain ownership of all rights in and to the Software, including all patents, copyrights, and other intellectual property rights.

Licensee may transfer the original Software and Documentation to another entity only in connection with the sale of the unit of the Instrument in which the Software is embedded, on the condition that the transferee agrees in writing to be bound by the terms of this agreement and Licensee provides to Licensor a copy of such agreement by the transferee.

Licensee will not reproduce, copy, decompile, disassemble, reverse engineer, modify, rent, lease, or create derivative works of the Software; transmit the Software electronically; or provide anyone with access to the Software over a network or otherwise.

Licensee will not export, re-export, resell, ship, or divert or cause to be exported, re-exported, resold, shipped, or diverted, directly or indirectly, the Software or Documentation to any country where the United States or Licensee's government or any agency thereof at the time of export or re-export requires an export license or other government approval without first obtaining such license or approval.

3. **SCOPE OF USE:** Licensee may use the Software only on the specific unit of the Instrument in which the Software is embedded. This license will terminate automatically if Licensee fails to comply with any term or condition of the license.

4. **LIMITED WARRANTY:** Licensor warrants that under normal use, the Software will perform the functions specified in the Documentation. If the Software does not conform to the Documentation, such that its functional performance is significantly impaired, and Licensee notifies Licensor in writing within ninety (90) days after the date of purchase and provides to Licensor a copy of the receipt of purchase, Licensor will have the option of refunding the purchase price or replacing the Software as Licensee's exclusive remedy.

5. **LIABILITY:** THE WARRANTY SET FORTH IN SECTION 4 IS EXCLUSIVE AND IN LIEU OF ALL OTHER WARRANTIES WHETHER STATUTORY, EXPRESS, OR IMPLIED (INCLUDING ALL WARRANTIES OF MERCHANTABILITY AND FITNESS FOR A PARTICULAR PURPOSE). LICENSOR WILL NOT BE LIABLE FOR INDIRECT, INCIDENTAL, SPECIAL, OR CONSEQUENTIAL DAMAGES.

6. By using the Software, Licensee acknowledges that Licensee has read this agreement and agrees to be bound by its terms and conditions. LICENSEE FURTHER AGREES THAT THIS AGREEMENT CONSTITUTES THE ENTIRE UNDERSTANDING OF LICENSEE AND LICENSOR WITH RESPECT TO THE SUBJECT MATTER HEREOF AND COMPLETELY SUPERSEDES ANY PRIOR UNDERSTANDING, EITHER ORAL OR WRITTEN. ANY MODIFICATION OF THIS AGREEMENT SHALL BE MADE ONLY BY MUTUAL AGREEMENT AND EVIDENCED BY WRITTEN AMENDMENT SIGNED BY BOTH PARTIES. This agreement shall be governed and interpreted by the laws of the State of Delaware.

7. **U.S. GOVERNMENT:** Licensor represents that the Software is either Commercial Computer Software as defined under DFARS 252.227-7014 (June 1995), or non-commercial computer software developed at private expense. If this license is acquired under a U.S. Government civilian agency contract, the Government's rights to use, modify, reproduce, release, perform, display, or disclose the Software are subject to restrictions set forth in FAR 52.227-19. If this license is acquired under a U.S. Government Department of Defense contract, the Government's rights to use, modify, reproduce, release, perform, display, or disclose the Software are subject to this license agreement. The License Fees identified in Exhibit A and the restrictions set forth in either FAR 52.227-19 or this license agreement do not apply to portions of the Software, if any, in which the U.S. Government has acquired Unlimited Rights.

TRADEMARK NOTICE

MOTOTRBO™ Professional Digital Two-Way Radio System

Motorola, MOTOTRBO, Private-Line, and Digital Private-Line are registered in the U.S. Patent and Trademark Office. by Motorola.

NXDN™ is a trademark of Icom Incorporated and Kenwood Corporation

All other product and service names are the property of their registered owners

1 PRE-OPERATION OVERVIEW

1.1 SCOPE OF MANUAL

This manual contains information for R8100 Series Communications System Analyzer. The R8100 incorporates many devices and functions, permitting a technician to completely monitor and service radio communications equipment in the shop and in the field.

1.2 SAFETY SUMMARY

The following general safety precautions must be observed during all phases of operation, service, and repair of this equipment. Failure to comply with these precautions or warnings violates safety standards of design, manufacture, and intended use of the equipment. Freedom Communication Technologies assumes no liability for the customer's failure to comply with these requirements.

The safety precautions and warnings listed below represent warnings of certain dangers of which Freedom Communication Technologies is aware. The user of the product should follow these warnings and all other safety precautions necessary for the safe operation of the equipment in the operating environment.

1.2.1 Analyzer Grounding

The R8100 is powered by a provided AC to DC converter connected to a grounded three-wire AC outlet. The negative (or “-“) output of the converter is internally connected to AC ground. Since the R8100 uses the converter’s DC negative as system ground, the analyzer is also connected to AC ground at the power outlet. As a result, most of the external connectors on the R8100 chassis are also at AC ground potential. **Warning: To minimize shock hazard, the R8100 must be operated with the provided converter and three-wire AC power cable. The power cable must be plugged into an approved three-contact electrical outlet.** If the unit is not operated from a properly grounded AC power source, any voltage potential between it and earth ground may cause an electrical shock.

1.2.2 Unit is Live When Plugged In or when Battery is Installed

Internal circuits are live when the DC power cable is plugged in, even when the R8100 has been placed in a non-operating mode using the front panel Power switch. To completely remove power from the analyzer internal circuits, disconnect the DC power plug and remove the battery. Position the equipment so that the DC power plug may be easily removed.

1.2.3 Keep Away From Live Circuits

Operating personnel must not remove equipment covers. Only factory and authorized service personnel may remove equipment covers for internal subassembly, component replacement, or any internal adjustment. Disconnect analyzer from all voltage sources before removing covers for adjustments, maintenance, or repairs. Capacitors inside may still be charged even if the analyzer is disconnected from the voltage source.

1.2.4 Explosive Atmosphere

Do not operate the equipment in the presence of flammable gases or fumes. Operation of any electrical equipment in such an environment constitutes a definite safety hazard.

1.3 WARNINGS AND CAUTIONS

Please observe several precautions when handling this equipment:



WARNING

The R8100 analyzer is designed to operate with a provided power adapter connected to a properly grounded three-wire AC power source. This configuration provides an earth ground connection to the R8100 internal ground and chassis. If the unit is not operated with the above configuration, any voltage potential between it and earth ground may cause an electrical shock.

CAUTION



This equipment contains internal parts that are subject to damage by static electricity (ESDS sensitive). Factory and authorized service personnel must follow proper ESDS precautions when handling internal components during repair or calibration.

CAUTION



The AC/DC adapter provided with this equipment is not rated for outdoor use. Do not use this adapter outdoors, especially near water or rain.

CAUTION



This equipment contains a Rechargeable Smart Lithium Ion Battery. Only use a model RRC2020 battery in the R8100. Do not attempt to insert any other type of battery into the battery enclosure of the R8100.

1.3.1 Analyzer Operating Voltage

The R8100 is powered by 15-16 VDC and operates from a three-wire AC outlet using an AC to DC adapter. **Warning:** *Only the adapter provided by Freedom Communication Technologies and shipped with the analyzer may be used to power the R8100. Do not substitute other adapters without first consulting Freedom Communication Technologies support personnel or a factory authorized service center.* Make certain to plug the adapter into a properly grounded three-wire AC outlet.

1.3.2 DC Power Source

Warning: *Connecting the analyzer DC input to an external power supply can, in the event of a power supply fault, cause the presence of hazardous voltages on the low voltage circuits of the analyzer.*

1.3.3 Battery

Battery Type

Rechargeable Lithium Ion (Li Ion) Battery pack

9x18650 cells (3S3P) with

11.25V / 8850mAh / 99.6 Wh

Compliance information

CE/ UL2054 / UL1642 / FCC IEC 62133 / EN6095 / ROHS UN 38.3 / PSE / RCM

Shipping

Remove battery from unit before shipment. See shipping requirements of your carrier.

See “Technical Specifications” for more details about the battery.

The maximum input levels are:

70 VAC RMS /100 VDC (R8100 input impedance set to 1 M Ω).

15 VAC RMS /24 VDC (R8100 input impedance set to 600 Ω).

1.3.4 Maximum Meter In Voltages

WARNING



To ensure the safety of the user, the Meter In port should not be used to measure equipment containing mains voltages.

The maximum input levels are:

33 VAC RMS /70 VDC (R8100 input impedance set to 1 M Ω)

15 VAC RMS /24 VDC (R8100 input impedance set to 600 Ω)

1.3.5 Replacement Fuses

No user serviceable fuses are available on the R8100. The unit is internally protected against overloads and risk of fire. If the R8100 fails to operate, return it to the factory or an authorized repair center for diagnosis and repair.

The R8100 Generate Output Port provides port protection against RF power input up to 5 W continuous. Power levels above 5 W may damage the port if applied for a significant amount of time. If the operator desires further port protection, the 50RF-038 fuse may be obtained from JFW Industries and attached to the Generate Output Port.

1.3.6 Other Cautions

Other cautions relating to the operation of the analyzer are stated in *Italics* throughout this manual.



CAUTION – HOT SURFACES

The RF I/O Port connector may become hot when inputting power. Exercise caution when removing cabling from the RF I/O Port.

1.3.7 User Maintenance of exterior surfaces

Clean only with a damp cloth and a mild detergent. Do not use abrasives, solvents, or alcohol. If the analyzer is used in a relatively dust-free environment, no other periodic maintenance should be required.

1.4 SERVICE

All R8100 Series Communications System Analyzers are calibrated and repaired at the Freedom Communication Technologies factory:

FREEDOM COMMUNICATION TECHNOLOGIES

2002 Synergy Blvd. Suite 200
Kilgore Texas 75662 USA
Tel/Fax: 1-844-903-7333

1.5 REPLACEMENT PARTS ORDERS

Send orders for user serviceable replacement parts to the Freedom Communication Technologies factory listed in Section 1.4. Be sure to include the complete identification number located on the equipment.

1.6 INSTALLATION

1.6.1 Packing

Foam pieces protect the analyzer, which is packed inside a carton. Save the packing container and materials for future use.

1.6.2 Initial Set-up

1. Place the analyzer on a workbench in the shop or mobile repair unit.
2. Flip out the two lever actuated foot extensions underneath the front of the unit to raise the analyzer for easier viewing.
3. Take the power cord of the AC to DC adapter and connect to a three-wire 100-240 VAC power source. Attach the cord's DC plug to the mating connector on the R8100 side panel.
4. Remove battery from separate box, and install at door on lower left side of unit (see Figure 2.1-2).
5. Remove accessories from the soft carry case (if provided).
6. Insert the whip antenna into the Antenna port, located to the right of the tuning knob on the front panel.
7. Press the Power switch ON, and allow the R8100 to boot up.

1.6.3 Warm-up

The analyzer can be used immediately after boot up with best accuracy achieved after a suitable warm-up period. The OCXO time base stabilizes within five minutes of operation, permitting frequency- dependent measurements at the specified accuracy of the analyzer, e.g., operating frequency, frequency error, audio tone generation, etc. For all other measurements, a minimum warm-up of 15 minutes is recommended. Full measurement stability is reached after 30 minutes of running in the operation environment. Before using the analyzer, review the operating procedures described in this manual.

ANALYZER OVERVIEW

1.7 Description

The R8100 Communication System Analyzer is a portable test instrument designed to monitor and service radio communications equipment over the frequency range of 250 kHz to 3 GHz. The R8100 generates and receives signals, measures modulation and frequency, and performs a variety of tests normally associated with the following equipment:

- RF Signal Generator
- Sensitive Measurement Receiver
- Spectrum Analyzer
- Duplex Offset Generator
- Oscilloscope
- Frequency Counter

- AC/DC Voltmeter
- RF Wattmeter
- Cable Fault Analyzer (optional)
- Tracking Generator (optional)
- Signaling Encoder/Decoder
- Signal Strength Meter
- SINAD Meter
- Distortion Analyzer

Firmware options provide test capability for advanced digital radio protocols such as P25 1&11, DMR, NXDN™, dPMR, TETRA, PTC and others as developed. The analyzer’s controls, indicators, and connectors are shown in Figures 2.1-1 and 2.1-2, with a description of these physical features detailed in Section 2.3.



Figure 2.1-1 Front Panel Controls, Indicators, and Connectors

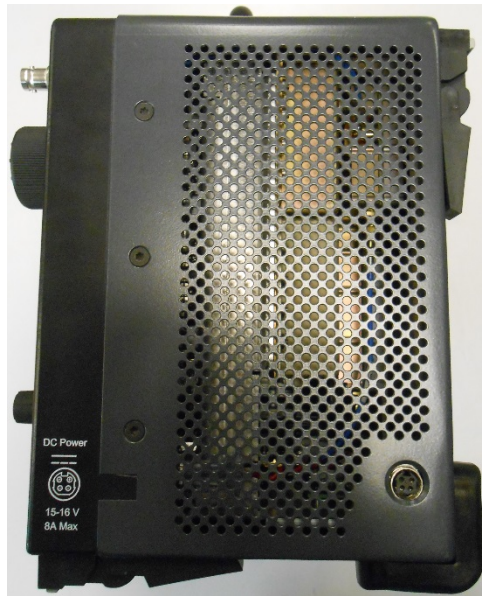

Figure 2.1-2 Left and Right Sides of the R8100

1.8 Technical Specifications

1.8.1 AC Adapter Specifications

Input Voltage:	100-240 VAC
Input Current:	2.5A Max
Input Frequency:	50-60 Hz
Operating Temp:	0° to +40° C
Storage Temp:	-20° to +85° C

1.8.2 Port Specifications

Demod Out:	±8V PK (600 Ohms), 13.3 mA
Mod In:	1V PK REF; ±1.5V PK MAX (600 Ohms), 2.5 mA
Mod Out:	±8V PK (100 Ohms), 80 mA
Meter In:	33 VAC RMS/70 VDC (1M Ohm) Max; 15 VAC RMS/24 VDC (600 Ohms) Max, 40 mA
RF Gen Out:	Do Not Input Power; +5 dBm Max Out, 250 kHz - 3 GHz (50 Ohms) Port Protection: 5 Watts/30 seconds Max
RF In:	Absolute <u>Max Power (250 kHz to 3 GHz) – 150 Watts (50 Ohms), 1.7A</u> 50 Watts - 5 minutes ON Max/5 minutes OFF Min (0° to 50° C) 150 Watts - 30 seconds ON Max/5 minutes OFF Min (25° to 50° C) 150 Watts - 1.5 minutes ON Max/15 minutes OFF Min (0° to 25° C)
RF Out:	-30 dBm Max Out, 250 kHz - 3 GHz (50 Ohms), 0.142 mA
Antenna:	0 dBm Max, 250 kHz - 3 GHz (50 Ohms), 4.5 mA Port Protection: 5 Watts Max

1.8.3 Mechanical Specifications

Weight:	< 14 lbs (6.4 kg)
Dimensions:	9.4" (23.9 cm) high, 12.7" (32.3 cm) wide, 7.5" (19.1 cm) deep
Operating Temp:	0° to 40° C
Storage Temp:	-30° to 80° C
Altitude:	Up to 2,000 m
Humidity:	80% maximum relative humidity

1.8.4 Battery Specifications

Battery Type

Rechargeable Lithium Ion (Li Ion) Battery pack
9x18650 cells (3S3P) with
11.25V / 8850mAh / 99.6 Wh

Compliance information

CE/ UL2054 / UL1642 / FCC IEC 62133 / EN6095 / ROHS UN 38.3 / PSE / RCM

Operating temperature

0c to 45 C (charging)
-20C to 55C (discharging)

Storage temperature

-20c to 50c max

Do not subject the battery to temperatures below -20C nor above +50C.

For additional technical specifications of the R8100, refer to the R8100 Datasheet located on the Freedom website, www.freedomcte.com.

1.9 Operator Interface and Controls

The R8100 was designed to be intuitive and easy to operate. A large LCD display screen shows the current operating mode along with associated settings, readings, and additional test submenus. Information about monitor settings and test results is visually grouped in outlined panels. The panels are highlighted when active for accepting data entries or changes in settings. Test results are shown numerically in labeled text fields and/or displayed graphically when appropriate.

The primary operating modes of the R8100 are Monitor, Generator, Duplex, Instrument, Test, and Settings. These are accessed with dedicated navigation keys near the main tuning knob on the front panel (see Figure 2.1-1). Commonly used operating adjustments are made with a few simple keystrokes. Several methods are available for entering numeric values and adjusting user settings. These include:

Function soft keys -- Two groups of non-dedicated (soft) keys are located at the bottom and right side of the main LCD display. The current key function is shown in the adjacent screen area and changes with the operating mode of the R8100 and the specific test in progress. Pressing a soft key executes one of several possible actions. These include opening a numeric data entry window, providing additional selections for user settings, activating new submenus, or performing a single measurement task (peak search, etc.). Multiple presses of the same key will toggle through all available selections for the setting.

Direct Entry -- Numeric values can be entered directly using the digital keypad when a data entry window is shown on the display. Existing values are modified using the Left/Right (◀▶) keys to move a highlighted cursor over the desired number. The cursor automatically steps to the right after a keypress. Pressing Enter completes the entry while the Esc key cancels the change. In the case of entering an RF frequency, pressing a scaling unit key (like “kHz”) also completes the numeric entry. **Note:** *Highlighted values may be adjusted using the Up/Down keys (▲▼) and tuning knob, but the R8100 will respond in real time as the changes are made.*

Tuning (Spin) Knob -- A separate tuning knob allows real time rotational adjustment of numeric values, simulating the smooth continuous operation of an analog tuning control. For example, the operator can manually scan an RF frequency segment for an unknown carrier. The spin knob adjusts whichever digit is highlighted in the data entry window by the Left/Right (◀▶) keys. Continuous rotation of the knob provides a step change equal to the smallest value of the highlighted digit. The knob also cycles through the selections available when a soft key activates a window that displays user-determined settings. Selections can also be chosen using the Up/Down (▲▼) keys. The spin knob has a “Press to Enter” function that has the same result as pressing the Enter key.

1.9.1 Front Panel Control Keys

Power Switch



Press to turn on the R8100 and cycle through the boot-up sequence. When operating, pressing the switch for three seconds or less turns off the R8100 with an orderly power down sequence (recommended). Pressing the switch for four seconds or more forces an abrupt shutdown (should be avoided).

Navigation Keys (Monitor, Generate, Duplex, Instrument, Test, Settings)



These keys determine the operating mode of the R8100. The current RF operating mode (Monitor, Generate, Duplex) is shown in a tab displayed at the bottom left of the main screen. An adjacent tab shows the current Test mode (Standard or optional modes like DMR, Project 25, NXDN, dPMR, TETRA, etc).

Soft Keys (unlabeled groups of seven buttons below and six buttons to the right of the LCD display)



Each soft key function is determined by the operating mode of the R8100 and the specific test in progress as indicated by an adjacent label on the LCD display.

Numeric Key Pad Area



For entering and controlling the format of alphanumeric data used by the R8100, specific key functions are as follows:

Keys (0-9) and (shifted letters A–Z)

These keys enter alphanumeric information into the analyzer. Pressing a key during data entry places a new value into the highlighted symbol or number on the analyzer screen. The analyzer then reacts to the newly entered information. If an invalid entry is attempted, the key press is ignored, and the numeral on the screen remains unchanged.

“Hot keys” 1, 2, 4/5, and 7/8 also serve as shortcuts, directly activating the four “Operating Zones” used for settings and metering in the R8100 Monitor, Generator, and Duplex modes (see paragraph 3.1.2). The zone displays are arranged on the R8100 main screen just like the outline around the hot keys. Pressing the hot key activates the zone and displays the associated settings submenu. Hot keys allow jumping from one zone to another while in Monitor, Generator, or Duplex Mode without navigating back to the main screen.

+/- Key

This key toggles the numeric sign from its present value to the negative of its present value.

Bksp Key

This key moves the display highlight to a previously-entered alphanumeric entry to allow editing.

Shift Key

This key changes the function of some numeric keys on the R8100 to alpha or letter designation (A–Z). It may also activate a special function on analyzer when appropriate.

GHz, MHz, KHz, Hz Keys

These keys apply the indicated scaling units to numeric RF frequency entries.

Enter Key

This key is equivalent to an “execute” key. It completes an entry from the alphanumeric keypad or a setting change so the R8100 will operate with the new value.

Esc Key

This key cancels an action before it is completed or returns to a previous menu. For example, pressing **Esc** while entering a value with the numeric keypad closes the direct entry window and leaves the

original value unchanged. **Esc** also returns to previous modes or windows when navigating the R8100's operational menus.

▲ ▼ (Up/Down) and ◀ ▶ (Left/Right) Keys

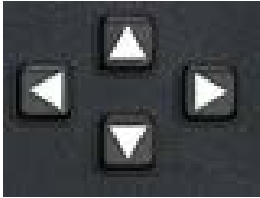

The arrow keys move a highlighted cursor over the alphanumeric digits in data entry windows to allow changes. They also step through the available selections in windows that display user-determined settings. The R8100 responds in real time to changes made by the arrow keys.

RF On/Off Key



This key disconnects the internal RF Generator from the RF In/Out and RF Gen Out ports. The current RF state is displayed at the bottom right of the screen next to the message bar. The key does not function in the Monitor operational mode.

1.9.2 Front Panel Control Knobs

Tuning (Spin) Knob



The tuning knob incrementally changes the value of the highlighted digit in an alphanumeric entry field. Clockwise rotation increases the value; counter-clockwise rotation decreases the value. The Tuning Knob affects the R8100 in real time, providing the equivalent of an analog rotational control at the cursor location for a numeric entry. The knob also cycles through the selections available when a soft key activates a window displaying user-determined settings. The knob may be pushed (clicked) to perform the same function as the Enter key.

Sql. Knob



These knobs adjust squelch control. Clockwise rotation increases the receiver signal threshold level required to open the squelch. The fully counter-clockwise position disables squelch, i.e. forced open. The level in dBm is displayed in the lower right corner of the main display. The level is applied to the input signal strength of the RF carrier (not the recovered audio) so that measurements can be performed on unmodulated carriers. For signals below the level, various demodulation operations cease, e.g. speaker audio is muted, and the Frequency Error and Deviation readings are blanked out.

The squelch threshold level range is based on RF Zone RF Zone / Monitor Mode Mon Port setting: Knob tolerance is 4 dB.

Mon Port	Minimum	Maximum
Antenna	-130 dBm	-20 dBm
RF In/Out	-100 dBm	+10 dBm

Note: *Additional functions utilize squelch; see RF Scan and Voice Loopback for various test modes.*

Vol. Knob

This knob controls volume of the speaker audio. A clockwise rotation increases the volume. Fully counter-clockwise mutes the volume.

1.9.3 Front Panel Display and Indicators

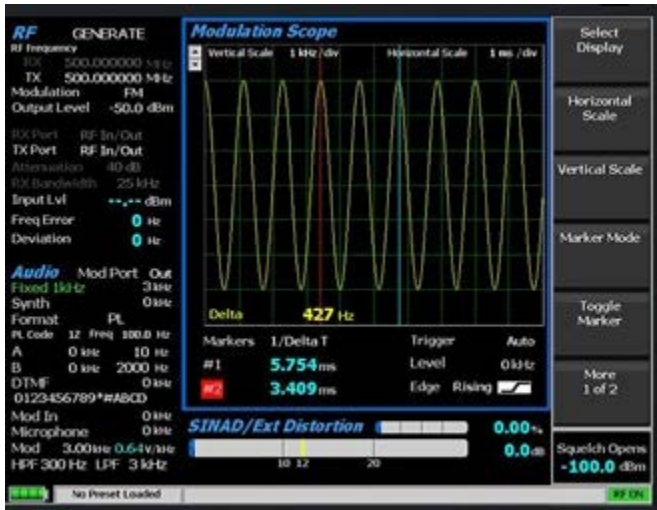

LCD Display

8.4 inch diagonal bit-mapped LCD provides operational status, data, soft key-driven menu based operating controls, and instructional information. It displays in digital, analog, and bar graph forms.

LED Indicators



The status of certain ports and controls is displayed by an adjacent LED indicator. An illuminated indicator means the port is active and is either accepting an input or providing an output signal. This applies to the **Antenna, Demod Out, Mod In/Out, Meter In, RF In/Out, and RF Gen Out** ports. An LED indicator next to the Sq. knob illuminates when the RF input signal to the R8100 is above the set squelch threshold.

Front Panel Connectors

Antenna



The low level RF input port is for the sensitive receiver monitor on the R8100. Used for off-the-air and other low level measurements where the RF power is below 0 dBm.

CAUTION



Do not apply high level RF Power to the Antenna port.

Lower front panel connectors



RF In/Out

Pictured above is the bidirectional port that routes RF input signals to the analyzer's internal monitor or output signals from the analyzer's internal generator. It also provides combined input/output in Duplex Mode and contains the RF wattmeter load. **Note:** *This is the only front panel connector to which high level RF power may be applied.*

RF Gen Out

This port serves as a high level generator RF output port isolated from the Monitor input.

CAUTION



Do not apply RF Power to the Generator port.

Meter In

Meter In serves as combined input port for oscilloscope vertical, SINAD meter, Distortion meter, and DVM/counter functions.

Mod In/Out

When configured as an output, this port provides a composite sum of all internally-generated modulation signals applied to the R8100 RF carrier. When set as an input, audio signals external to the R8100 can be used to modulate the RF carrier. **Note:** *The audio signals must equal +/- 1Vpk to provide a reference for accurate display of the applied modulation level.*

CAUTION



Do not exceed +/- 1.5 Vpk on the Mod In/Out port or damage may occur to internal circuitry.

Demod Out

This port provides the demodulated (recovered) audio output from a received carrier when the R8100 is in Monitor or Duplex Mode.

Mic In

The RJ-45 connector is for external accessory microphone.

1.9.3.1 Side Panel Connectors



VGA Out

This connector provides a 15 pin connection to external VGA format color monitor.

USB (2)

USB serial ports may be used for external peripheral devices such as keyboard or flash drive.

Ethernet

This connector serves as an RJ-45 connector for 10/100 Mbps Ethernet LAN port for a computer network interface.

Ref. In/Out

This BNC connector provides input/output for 10 MHz reference frequency. Input impedance is 50 Ω . Input level requirement is 70 mV to 1V RMS. Output level is approximately 250mV RMS.

DC Power

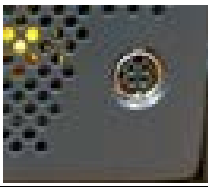

Pictured above is the primary DC power input port. **Note:** *The R8100 requires 24 VDC; connect only the AC to DC adapter provided by Freedom Communication Technologies to this port. Do not substitute other adapters without first consulting Freedom Communication Technologies support personnel or a factory authorized service center.*

2 OPERATION

2.1 Overview

The R8100 is operated using an intuitive and easy to navigate system of front panel keys and menu- driven display interface. Dedicated navigation (blue) keys on the front panel enable the primary operating modes. Functions within the main operating modes have an associated display area where important operational settings and measurements are grouped for easy viewing (see Figure 3.1.1-1). The groupings include the RF Zone, Audio Zone, Display Zone and Meter Zone. These “Operating Zones” are highlighted when active for user entry as shown in Figure 3.1.1-2 for the RF Zone. Menus next to the soft keys on the right and bottom of the display show the Zone settings available for adjustment. Pressing a soft key menu brings up a data entry window or additional submenus as required.

The primary operating modes of the R8100 are controlled by the following blue navigation buttons left of the ANTENNA port on the front panel:

Monitor

This blue key navigates the system to RF Receiver Mode with frequency coverage from 250 kHz to 3 GHz. It provides signal strength, frequency accuracy, and other metering results while decoding the modulation content of incoming RF carriers to produce a recovered baseband signal. Additional analysis is provided by spectrum analyzer and modulation scopes.

Generate

This key activates the RF Generator Mode with frequency coverage from 250 kHz to 3 GHz. It produces an RF carrier with user-selected output level, modulation type (AM, FM, etc.), and tone encoding formats.

Duplex

Duplex Mode allows simultaneous operation and independent control of the generator and receiver.

Instrument

This blue key directly accesses a full screen version of graphically-displayed test functions, such as the spectrum analyzer, tracking generator, and oscilloscope.

Test

The Test key recalls or saves operator preset analyzer settings and access application-specific test functions.

Settings

The Settings key provides the system configuration mode for viewing and entering general operating parameters for the R8100 such as the date/time, network/port settings for remote control, etc.

2.1.1 Basic navigation and operator control

Status information is displayed at the bottom of the display, listed from left to right: battery state, current test mode, message bar, and RF On/Off state.

Pressing a navigation button places the R8100 into the labeled operating mode or screen and presents related information on the display. Figure 3.1.1-1 shows the R8100 in Monitor Mode after pressing the Monitor navigation button.

The RF Zone upper left display area shows the RF settings and measured results during monitor operation. This includes the frequency of operation (Mon Freq), the signal input port (Mon Port), the input Attenuation, and other relevant data.

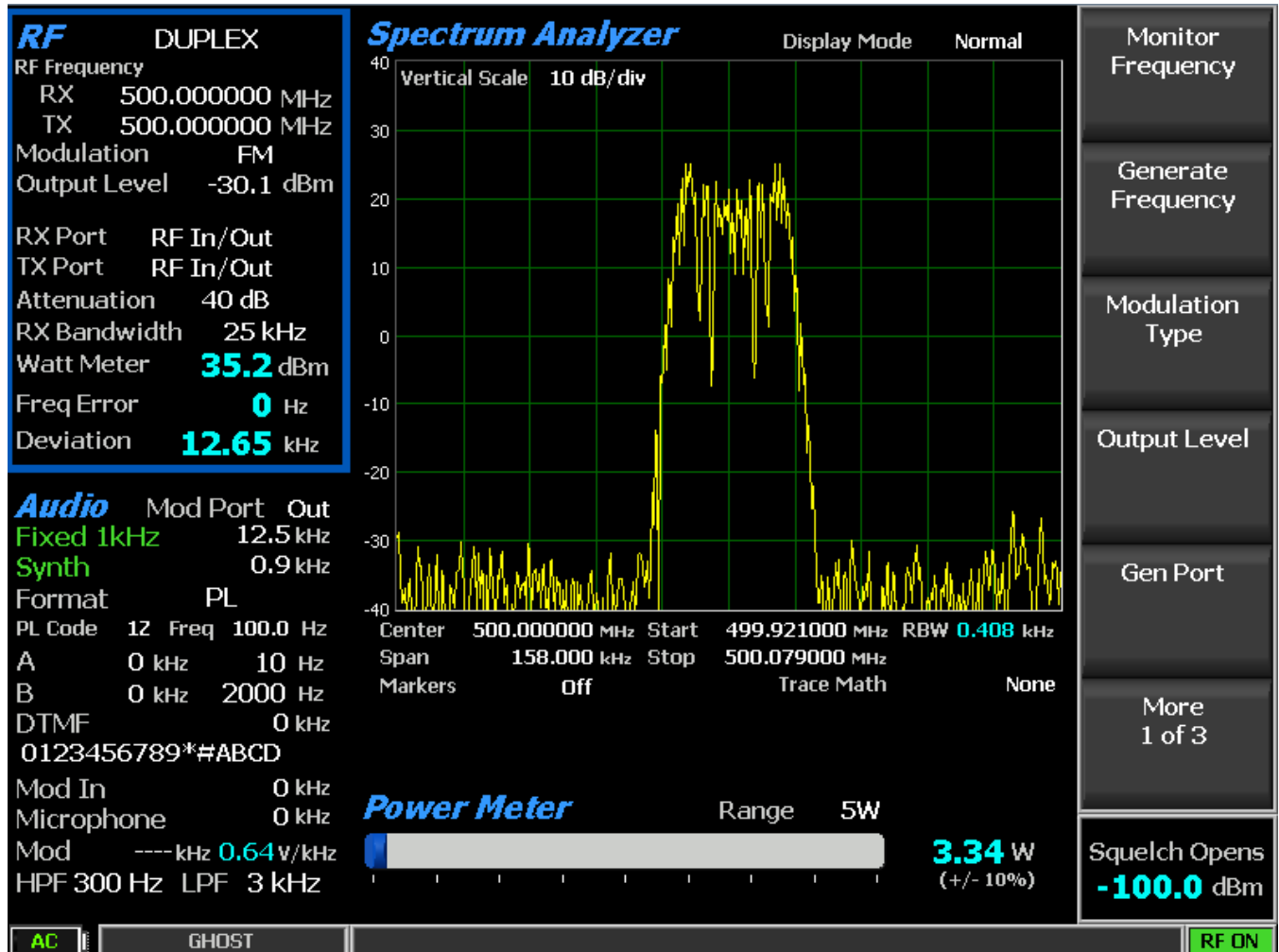

Figure 3.1.1-1 Main screen in Monitor Mode showing related information in grouped display zones. Six soft keys to the right of the monitor enable selection and adjustment of monitor-specific modes and parameters. Figure 3.1.1-1 shows the R8100 display after pressing hard key number 1 on the numerical keyboard while in Monitor or Duplex Mode. **Note:** The RF Zone section is highlighted. This indicates the RF Zone is active for user entry, and a new submenu with related selections appears next to the soft keys on the right. Pressing the **Esc** key returns the R8100 to the previous menu.

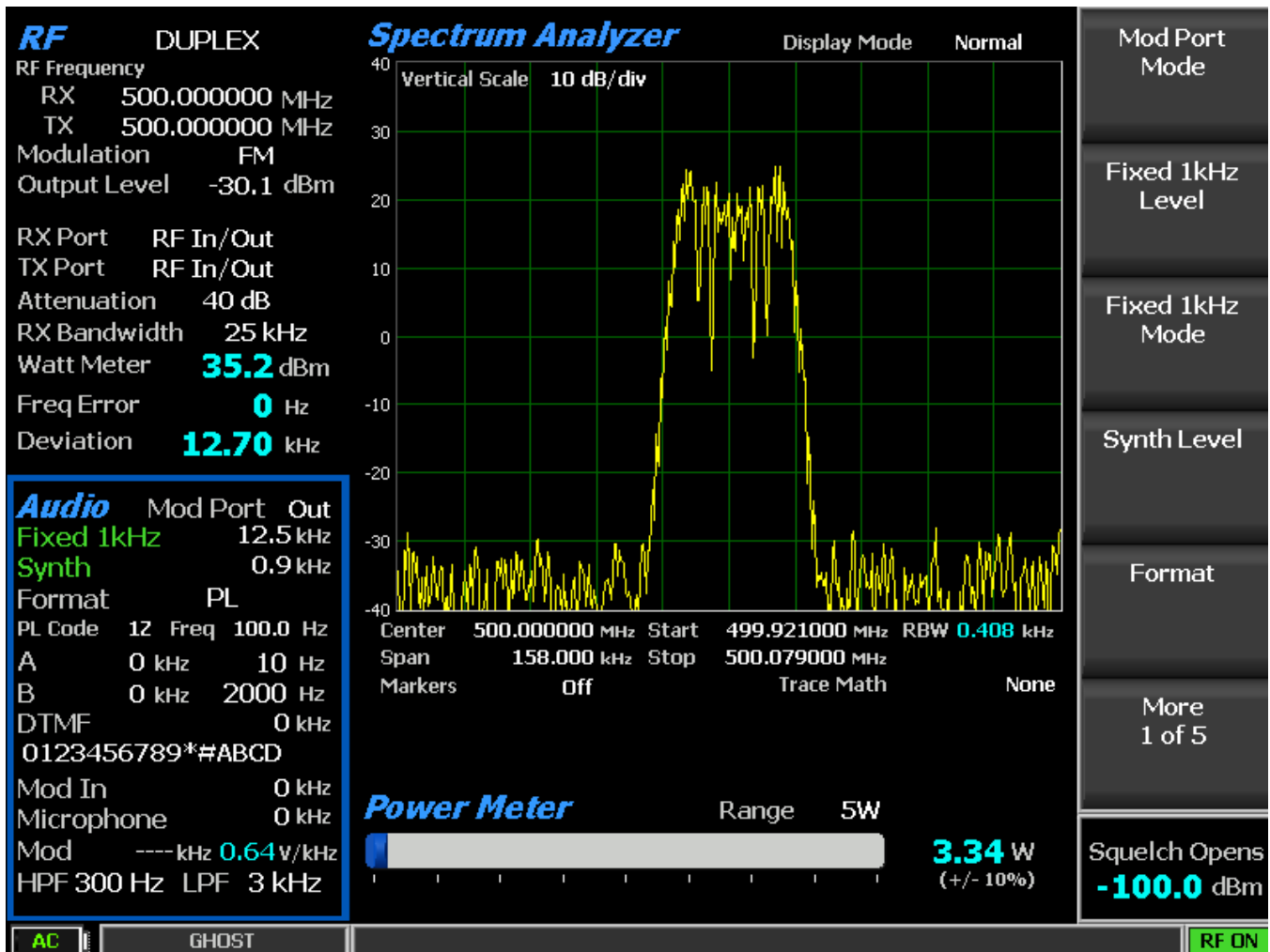

Figure 3.1.1-2 Main display area after Audio Zone soft key press

Figure 3.1.1-2 shows the R8100 display after pressing the hard key number 4 on the numerical keyboard. Pressing the Fixed 1kHz Level soft key brings up a data entry window for user-entered data as shown in Figure 3.1.1-4. The value can be adjusted with the front panel keypad and tuning controls. The Left/Right (◀▶) keys move the highlight over the desired number field. Numeric changes are entered directly via the keypad or in steps using the Up/Down (▲▼) keys or Tuning Knob.

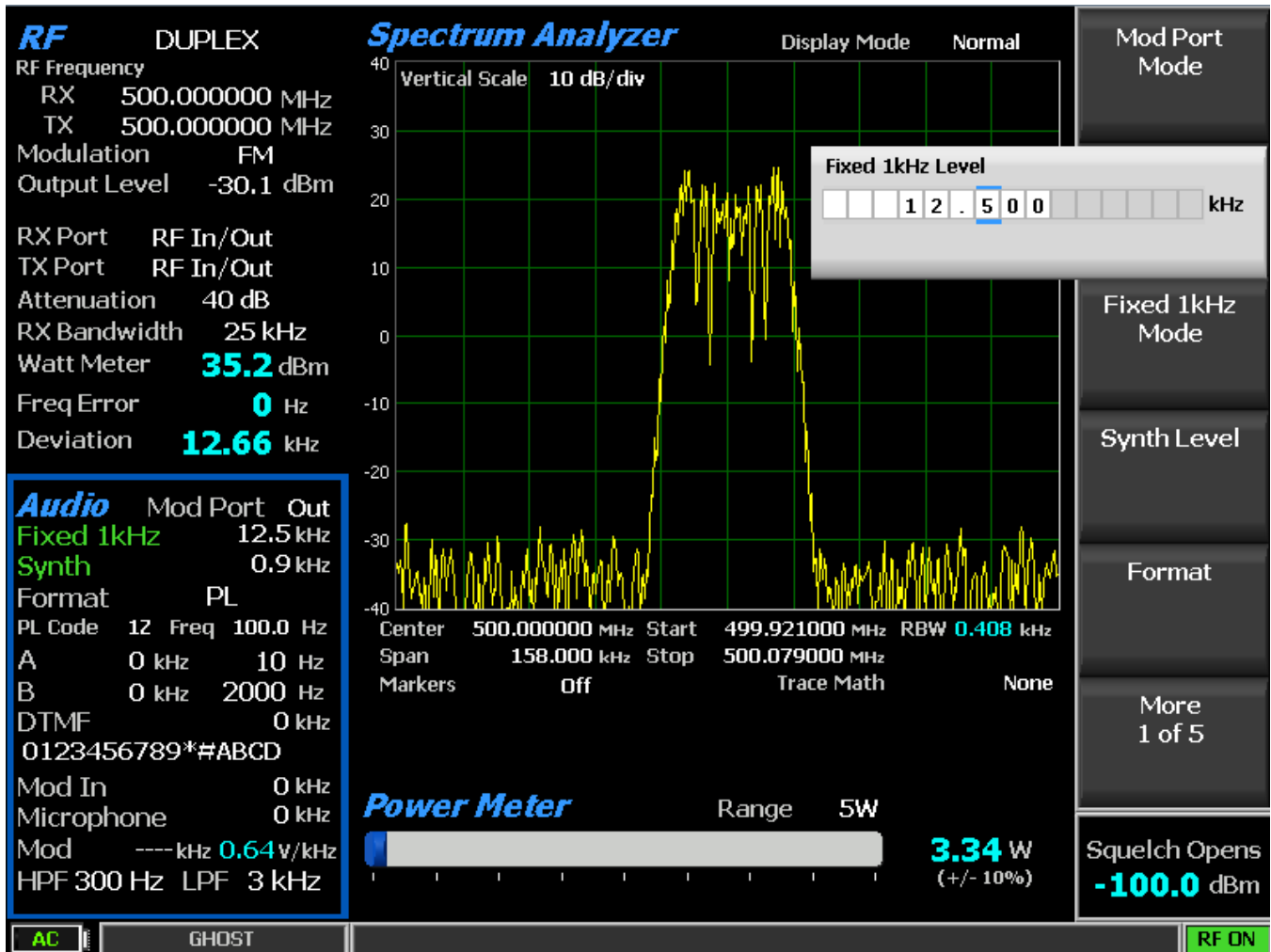

Figure 3.1.1-4 Audio Zone data entry for Fixed 1 kHz Level

Data entry windows always start with the left most numeric field highlighted. Entering a value with the numeric keypad automatically steps the highlight to the right, speeding the entry process. Pressing the Up/Down (\blacktriangle / \blacktriangledown) keys or rotating the Tuning Knob adjusts the value in step increments. If the value in the numeric field rises above nine or goes below zero, the excess is rolled over into the base number. The R8100 stops accepting numeric changes when the value reaches the maximum or minimum allowed for that parameter. During the entry process, pressing Enter completes the entry, and pressing Esc cancels the input.

2.1.2 Hot keys for fast navigation in Monitor, Audio, Display and Meter zones

“Hot keys” 1, 2, 4, and 5 on the numeric keypad are shortcuts, directly activating the four “Operating Zones” used for settings and metering in the R8100 Monitor, Generator, and Duplex Modes. The outline around the hot keys is drawn to match the arrangement of the Operating Zone displays on the R8100 main screen (see Figure 3.1.2-1).

Pressing a hot key directly activates the Operating Zone and displays its associated settings submenu. This allows jumping from one zone to another while in Monitor, Generator, or Duplex Mode without navigating back to the main screen. The hot keys activate the respective zones and submenu as follows:

RF Zone – Press numeric hot key 1

Audio Zone – Press numeric hot key 4

Display Zone – Press numeric hot key 2

Meter Zone – Press numeric hot key 5



Figure 3.1.2-1 Outline around Numeric Keypad Hot Keys

Note: Hot keys are inactive whenever a data entry window is open or the horizontal soft key menu below the display is shown. Press the Esc key to close data entry windows or horizontal soft key menus before using hot keys in Monitor, Generator, or Duplex Mode.

2.2 Operating Instructions

The main operating modes of the R8100 are oriented towards testing two-way radios and related infrastructure. For a majority of applications, the R8100 will either receive or generate an RF carrier and display carrier-specific information such as power level, modulation content, spectral content, etc. The description of R8100 operation will initially focus on basic use as a monitor and generator, then expand into more detail on associated functions.

2.2.1 RF Zone / Monitor Mode

The R8100 Monitor Mode provides the analyzer's receiver function used for testing radio transmitters. It is capable of monitoring over the air (OTA) RF signals through its ANTENNA port or with a direct connection to the transmitter at the RF In/Out port. The operating frequency range is from 250 kHz to 3.0 GHz in 1 Hz increments with selectable bandwidths between 6.25 kHz and 200 kHz. The analyzer processes AM and FM modulated carriers and a variety of audio encoding formats. Once set to an RF carrier's center frequency, the R8100 accurately determines the frequency error, power level, and modulation characteristics. These are shown at the bottom of the RF Zone section of the main display below the separator line (See Figure 3.2.1-1). Expanded versions of these measurements are also available in the Bar Graphs selection in the Display Zone.

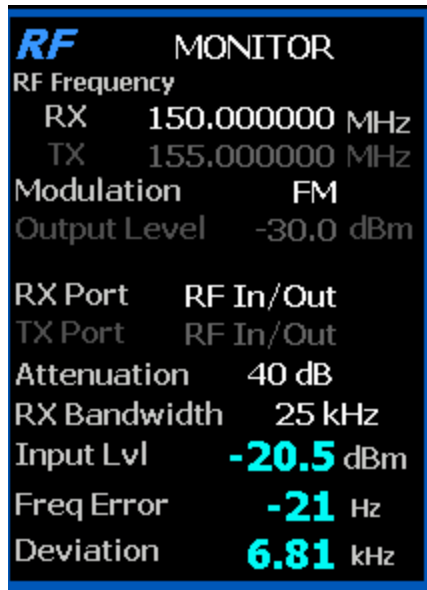

Figure 3.2.1-1 RF Zone display area showing Monitor Mode data

To enable the R8100 Monitor Mode, press the **Monitor** navigation button from within any menu and confirm that “Monitor” is indicated in the lower left corner of the R8100 main display. Then press the **Esc** button repeatedly until the soft keys to the right of the display area indicate RF Zone, Audio Zone, Display Zone, and Meter Zone. This places the R8100 at the entry point for adjusting basic Monitor Mode settings such as frequency, modulation type, etc. **Note:** *Monitor Mode allows the operator to bypass standard menu navigation and jump directly to another Zone and its settings submenu with the appropriate hot key (see paragraph 3.1.2).*

Input Level

This field displays the RF input level of the received carrier. Different units may be selected with the Input Level Units setting.

Note: *When the RF input power on the RF In/Out port is above +20 dBm (100 mW), the R8100 utilizes a broadband power detector for the measurement. The “Input Lvl” field in the RF Zone changes to “Watt Meter” to indicate this measurement mode.*

Watt Meter

This field displays the level of broadband power applied to the RF In/Out port. Different units may be selected with the Input Level Units setting in the RF Zone submenu.

Note: *For best Watt Meter accuracy, disable the Pre-amplifier in Monitor Mode, and set the Gen Port in Generate Mode to RF In/Out.*

Freq Error

This field displays the frequency difference of the received carrier frequency minus the R8100 Monitor Frequency.

Deviation

This field displays the positive peak frequency deviation of the received modulated carrier (i.e. from the Frequency Error mean), which is available when Modulation Mode is FM. See negative peak frequency deviation with Display Zone Bar Graphs.

%AM

This field displays the positive peak AM percentage of the received modulated carrier, which is available when Modulation Mode is AM.

Setting the Monitor's RF operating parameters in the RF Zone

To adjust the RF settings, press the hot key 1. The RF Zone area of the display highlights, and the soft key submenu shown in Figure 3.2.1-2 appears with the following selections:

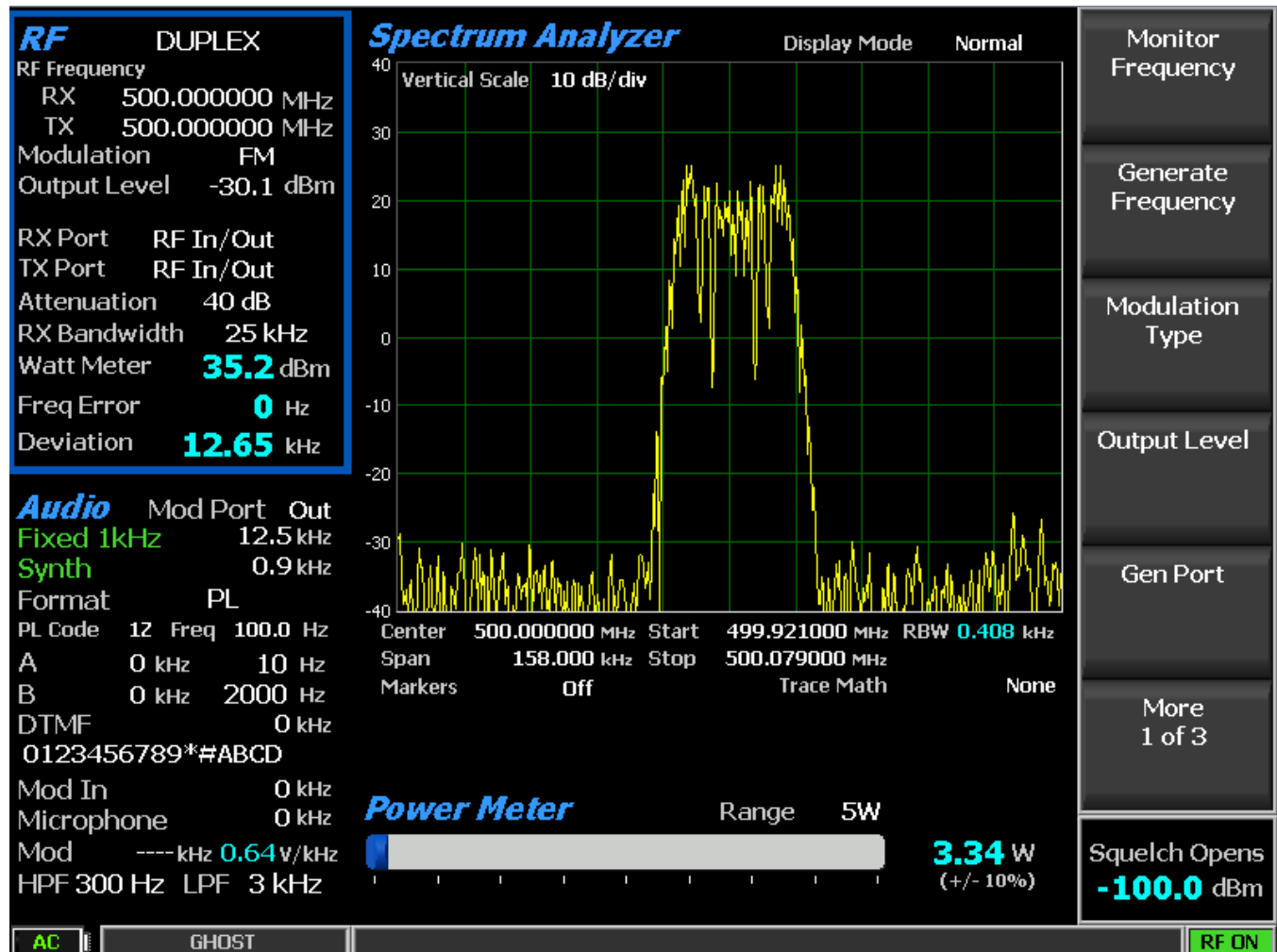

Figure 3.2.1-2 Monitor Mode submenu after RF Zone soft key press

Monitor Frequency

This soft key sets the desired monitor frequency in a data entry window from 250 kHz to 3 GHz using the arrow keys, keypad, or tuning knob. Pressing Enter completes the change, and Esc cancels the entry.

Copy Frequency to Generator

This key sets the R8100 Generator to the same frequency as the Monitor.

Modulation Type

This key activates a horizontal submenu with selections for the signal demodulation mode of the R8100 receiver - either FM or AM.

Bandwidth

This soft key selects the IF detection bandwidth via horizontal soft keys from 6.25 kHz (narrow) to 200 kHz (wide).

Note: For best measurement quality, always set an IF bandwidth no wider than necessary for the signal carrier of interest. Example: Typical channel spacing for modern narrowband two-way radio is 12.5 kHz. Monitor IF bandwidths that are wider than needed for the channel spacing, allow more noise in the measurement, and degrade the quality of readings for deviation, frequency error, SINAD, etc.

Attenuation

This key adjusts the RF input signal attenuation in 2 dB steps from 0 to 90 dB in a selection table window using the Up/Down (▲ ▼) keys or spin knob.

Pre-Amplifier

This soft key enables a supplementary input amplifier that extends the sensitivity of the RF Monitor by improving the S/N ratio for low signal levels. Green highlighted “AMP” text appears in the RF Display Zone whenever the Pre-Amplifier is active.

Note: By default, the R8100 Pre-Amplifier Auto-Off feature disables the Pre-Amplifier for best accuracy during broadband power (Watt Meter) measurements (see Section 3.2.9.2). When enabled, avoid input overload and erroneous signal strength readings by using the pre-amplifier only under the following conditions:

Input Port	Maximum input level for using pre-amplifier
Antenna	(Input signal in dBm – Attenuator setting) is equal or less than -40 dBm
RF In/Out	(Input signal in dBm – Attenuator setting) is equal or less than -10 dBm

Mon Port

This key changes monitoring of the RF input signal from either the ANTENNA or the RF In/Out front panel connectors. Choose in a selection table window using the Up/Down (▲ ▼) keys or spin knob.

CAUTION



Do not apply input power to the Antenna input port.

Note: If RF Level Offset is enabled, the Mon Port label is cyan-colored, indicating that RX measurements are adjusted by the Mon Port-specific offset. See Section 2.2.8.2 for details.

Input Level Units

This key selects the measuring units for the RF Zone input level display (“Input Lvl”) via horizontal soft keys. Choices are Volts, Watts, or dBm.

Direct entry example:

Figures 3.2.1-3 and 3.2.1-4 show the data entry and RF Zone windows after pressing the Monitor Frequency soft key and entering 501.234567 MHz via the numeric keypad. The data entry window starts with the left most numeric field highlighted. As the value is entered on the keypad, the highlight automatically steps to the right. Pressing Enter or a units key (MHz, etc.) completes the change while Esc cancels the entry.



Figure 3.2.1-3 Data entry window before and after Monitor frequency change

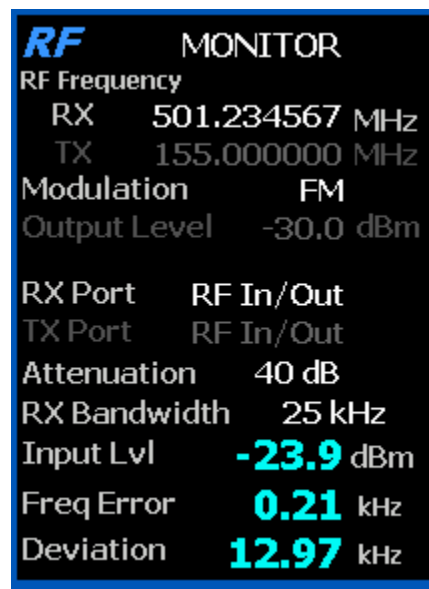

Figure 3.2.1-4 RF Zone display area after Monitor frequency change

Real time adjustments using the tuning knob and arrow keys

In many data entry windows, the R8100 will respond immediately before the Enter key is pressed if the Up/Down (▲▼) keys or tuning (spin) knob are used to change the numeric value. An example of this is the frequency entry adjustment in Monitor Mode. Here, the operator can use the tuning (spin) knob to

manually scan an RF frequency segment for an unknown carrier with the smooth action associated with an analog control. The spin knob adjusts whichever digit is highlighted in the data entry field by the Left/Right (◀▶) cursor control buttons. Continuous rotation of the knob steps the frequency adjustment by the smallest value of the highlighted digit. Moving the highlight to a different field allows coarse (faster) or fine (slower) tuning as desired. **The tuning knob may be pressed at any time to Enter the current value.** The Up/Down (▲▼) keys provide precise step changes for final adjustment after the R8100 is quickly dialed close to the desired frequency.

2.2.2 RF Zone / Generate Mode

The R8100 Generator Mode is the analyzer's transmitter function used for testing radio receivers over a frequency range of 250 kHz to 3.0 GHz in 1 Hz increments. The RF carrier output is accessible through the RF Gen Out or RF In/Out ports for over the air (OTA) operation or direct coupling into a receiver. The output level is adjustable from -95 dBm to +5 dBm on the RF Gen Out port, and -130 dBm to -30 dBm on the RF In/Out port. A variety of modulation types and encoding formats are available for the RF carrier. Figure 3.2.2-1 shows the R8100 in the Generate Mode in the RF Zone section of the main display.

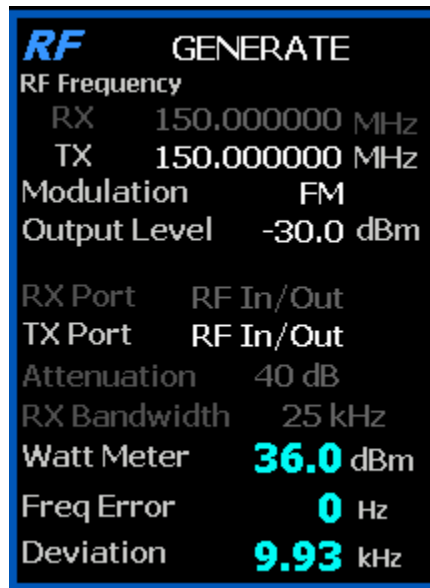

Figure 3.2.2-1 RF Zone display area showing Generator Mode data

To enable the R8100 Generate Mode, press the **Generate** navigation button from within any menu, and confirm that “Generate” is indicated in the lower left corner of the R8100 main display. Then press the **Esc** button repeatedly until the soft keys to the right of the display area indicate RF Zone, Audio Zone, Display Zone, and Meter Zone. This places the R8100 at the entry point for adjusting basic Generate Mode settings such as frequency, modulation type, etc. **Note:** *Generate Mode allows the operator to bypass standard menu navigation and jump directly to a zone and its settings submenu with the appropriate hot key (see paragraph 3.1.2).*

Output Level

Output Lvl (gray) displays the Generator RF output level. Volts, Watts, or dBm units may be selected with the Output Level Units setting in the RF Zone submenu.

Setting the Generator's RF operating parameters in the RF Zone

To adjust the RF settings, press the RF Zone soft key or hot key 1. The RF Zone area of the display highlights, and a new soft key submenu appears as shown in Figure 3.2.2-2. The soft key selections are as follows:

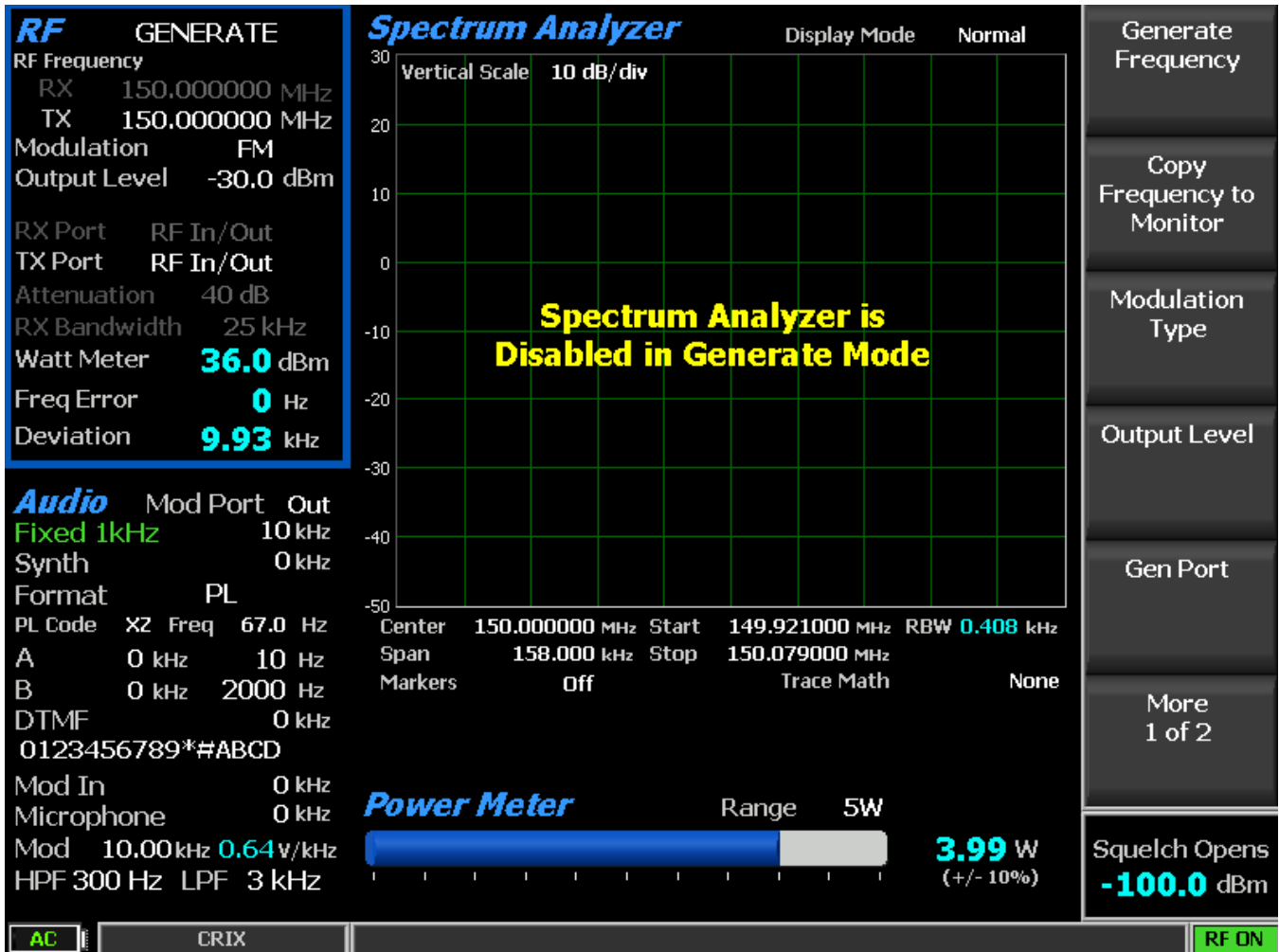

Figure 3.2.2-2 Generator Mode submenu after RF Zone soft key press

Generator Frequency

This soft key sets the desired monitor frequency in a data entry window from 250 kHz to 3 GHz using the arrow keys, keypad, or tuning knob. Pressing Enter completes the change, and Esc cancels the entry.

Copy Frequency to Monitor

This key sets the R8100 Monitor to the same frequency as the Generator.

Modulation Type

This key activates a horizontal submenu with selections for the carrier modulation mode of the R8100 – either FM or AM. **Note:** *Output Level upper limits are reduced in AM to accommodate peak power levels.*

Output Level

Output Level (white) adjusts the RF level of the transmitted carrier for the active output port. Range is from -95 dBm to +5 dBm on the RF Gen Out port, and -130 dBm to -30 dBm on the RF In/Out port. When Modulation Type is AM, the upper limits are -1 dBm and -36 dBm respectively.

Gen Port

Choose the active port (RF In/Out or Gen Out) for the R8100 carrier output in a selection table using the Up/Down (▲▼) keys or spin knob.

Note: *If RF Level Offset is enabled, the Gen Port label is cyan-colored, indicating that Output Level amplitudes are adjusted by the Gen Port-specific offset. See Section 2.2.8.2 for details.*

Bandwidth

This soft key sets the maximum occupied bandwidth in kHz for the R8100's carrier via a set of horizontal soft keys. The range is from 6.25 kHz (narrow) to 200 kHz (wide).

Output Level Units

This key selects the measurement units for setting the Generator RF output level via horizontal soft keys. Choices are Volts, Watts, or dBm, and the level is displayed in the Output Level field in the RF Zone display window.

2.2.3 RF Zone / Duplex Mode

The R8100 Duplex Mode provides simultaneous generator and monitor operation for testing radio transceivers with full duplex capability or radio systems with offset transmit and receive frequencies. All RF parameters of the R8100 generator and monitor are independently adjustable during Duplex operation except the shared functions of modulation type and bandwidth. Duplex Mode provides offset frequency operation of the generator and monitor over the full frequency range of the R8100. Figure 3.2.3-1 shows Duplex operation of the R8100 in the RF Zone section of the main display.

Note: *If RF Level Offset is enabled, the Gen Port and Mon Port labels are cyan-colored, indicating that Output Level amplitudes and RX measurements are adjusted by the Gen Port and Mon Port-specific offsets. See Section 2.2.8.2 for details.*

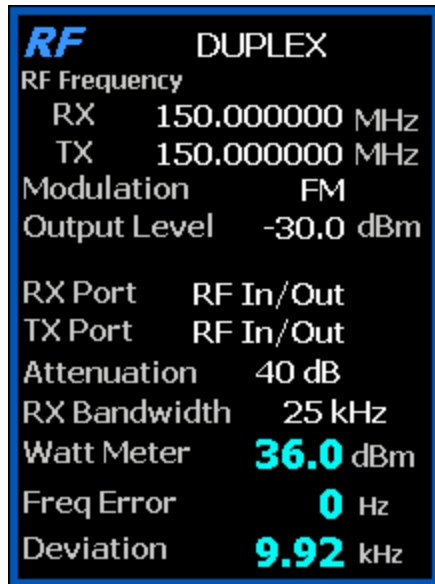

Figure 3.2.3-1 RF Zone display after Duplex key press

To enable the R8100 Generate Mode, press the **Duplex** navigation button from within any menu and confirm that “Duplex” is indicated in the lower left corner of the R8100 main display. Then press the **Esc** button repeatedly until the soft keys to the right of the display area indicate RF Zone, Audio Zone, Display Zone, and Meter Zone. This places the R8100 at the entry point for adjusting basic Duplex Mode settings such as frequency, modulation type, etc. **Note:** *In Duplex Mode, the operator can bypass standard menu navigation and jump directly to a Zone and its settings submenu with the appropriate hot key (see paragraph 3.1.2).*

Setting RF operating parameters in Duplex Mode in the RF Zone

To adjust the RF settings, press the RF Zone soft key or hot key 1. The RF Zone area of the display highlights, and the soft key submenu shown in Figure 3.2.3-2 appears. Most of the soft keys duplicate the independent generator and monitor adjustments described in Sections 3.2.1 and 3.2.2. The Modulation Type and Bandwidth settings are common and simultaneously applied to the generator and monitor.

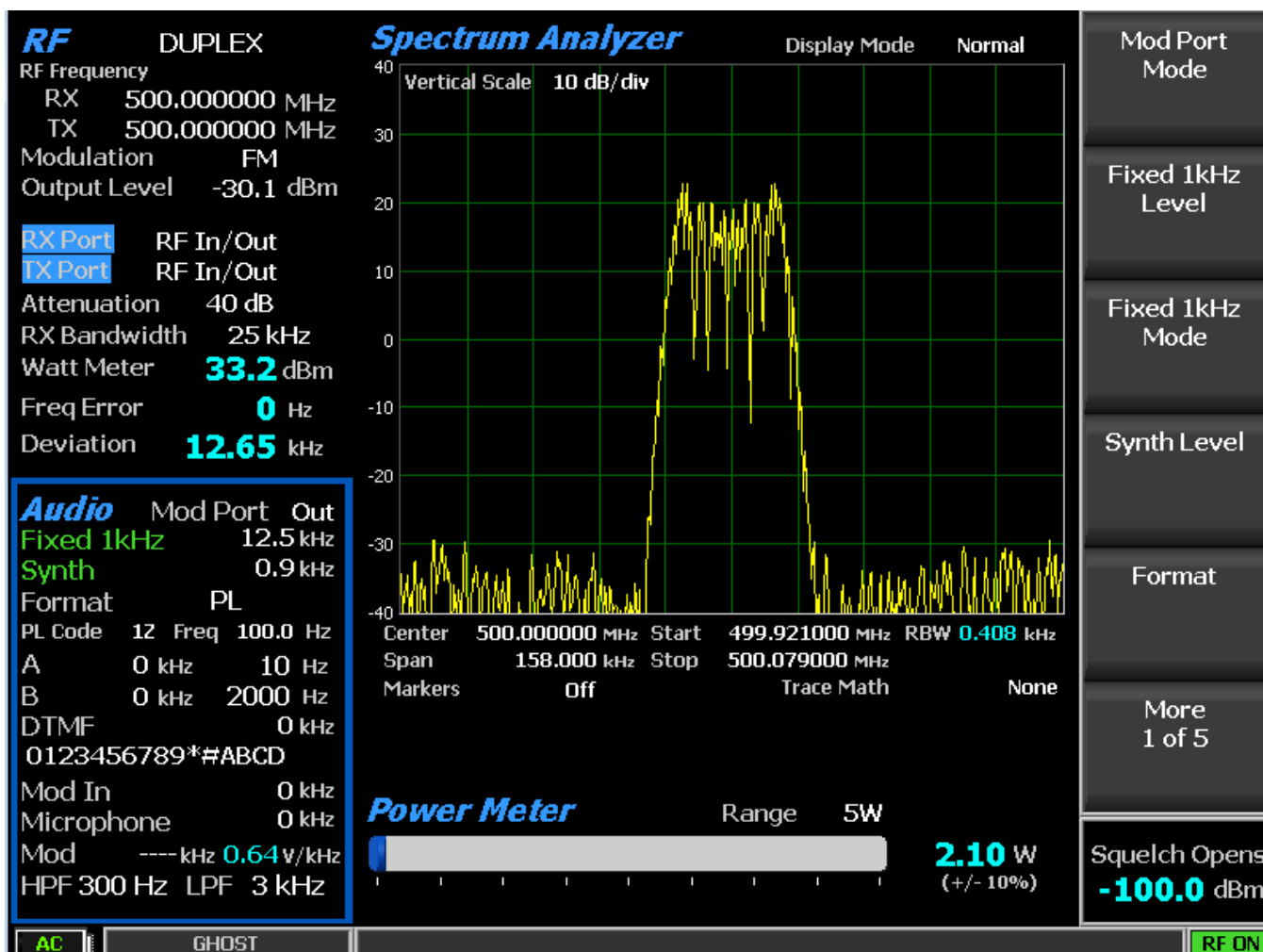

Figure 3.2.3-2 Duplex Mode submenu after RF Zone soft key press

Audio Zone

The R8100 Generate and Monitor Modes have a variety of audio settings and encoding/decoding features, many of which are associated with modulation of the carrier transmitted from the R8100. The audio/modulation sources include a fixed 1 kHz tone generator, independent variable frequency Tone A/Tone B generators, a dedicated DTMF (Dual Tone Multi-Frequency) generator, and a synthesizer for generating various other encoding formats used in two-way radio testing. The Audio Zone also has the baseband filter settings for the R8100 Monitor Mode. Decoding function displays for the carrier-recovered audio are primarily located in the Meter Zone.

The display presentation for the Audio Zone on the R8100 main screen changes depending on the R8100 mode. Figure 3.2.4-1 shows the Audio Zone display area with the R8100 in Generate Mode. Note the field description of “Mod Sum” towards the upper right and that the level is in kHz. In Generate Mode, this synthesizer-generated composite audio modulates the internally-generated RF carrier on the R8100. The carrier modulation level is indicated in units of deviation for FM (kHz) or percent for AM. The composite audio modulation is also available on the Mod In/Out connector.

Audio		
Mod Port		Out
Fixed 1kHz		5 kHz
Synth		0.7 kHz
Format	A/B	Sequence
A/B Sequence		1
A	0 kHz	10 Hz
B	0 kHz	2000 Hz
DTMF		0 kHz
0123456789*#ABCD		
Mod In		0 kHz
Microphone		0 kHz
Mod	5.70 kHz	0.64 V/kHz
HPF	300 Hz	LPF 3 kHz

Figure 3.2.4-1 Audio Zone display with the R8100 in Generate Mode

Figure 3.2.4-2 shows the Audio Zone display area with the R8100 in Monitor Mode. In Monitor Mode, the audio synthesizers operate like a standalone audio generator since they are not modulating a carrier internal to the R8100. Note the field description of “Audio Sum” towards the upper right and that the level is in Volts (V). This level is the composite sum of all audio sources enabled. The composite audio signal is available on the Mod In/Out connector.

Audio		
Fixed 1kHz		0.5 v
Synth		0.25 v
Format	A/B	Sequence
A/B Sequence		1
A	0 v	10 Hz
B	0 v	2000 Hz
DTMF		0 v
0123456789*#ABCD		
Microphone In		0 v
Audio Sum		0.75 v
HPF	300 Hz	LPF 3 kHz

Figure 3.2.4-2 Audio Zone display with the R8100 in Monitor Mode

2.2.3.1 *Setting audio operating parameters in Monitor Mode*

Figure 3.2.4.1-1 shows page one of the Audio Zone submenu in Monitor Mode after the soft key press. Recall that the R8100 audio synthesizers operate like a standalone audio generator in this mode, and the signal is directed to the Mod In/Out connector. This is the first of several menu pages with settings mainly associated with the audio synthesizer. The number of menu pages varies with the selected audio format.

The last page of the Audio Zone submenu also contains the baseband filter settings for the R8100 Monitor Mode.

Note: Audio Zone submenu screens display common settings along with menu choices that change to reflect the Format (signal type) chosen for the audio synthesizer. Different submenu screens and settings appear when other encoding types such as DPL, A/B Sequence, or 5/6 Tone are selected with the Format soft key. The following sections will first describe the common settings, followed by the alternate settings specific to each encoding format.

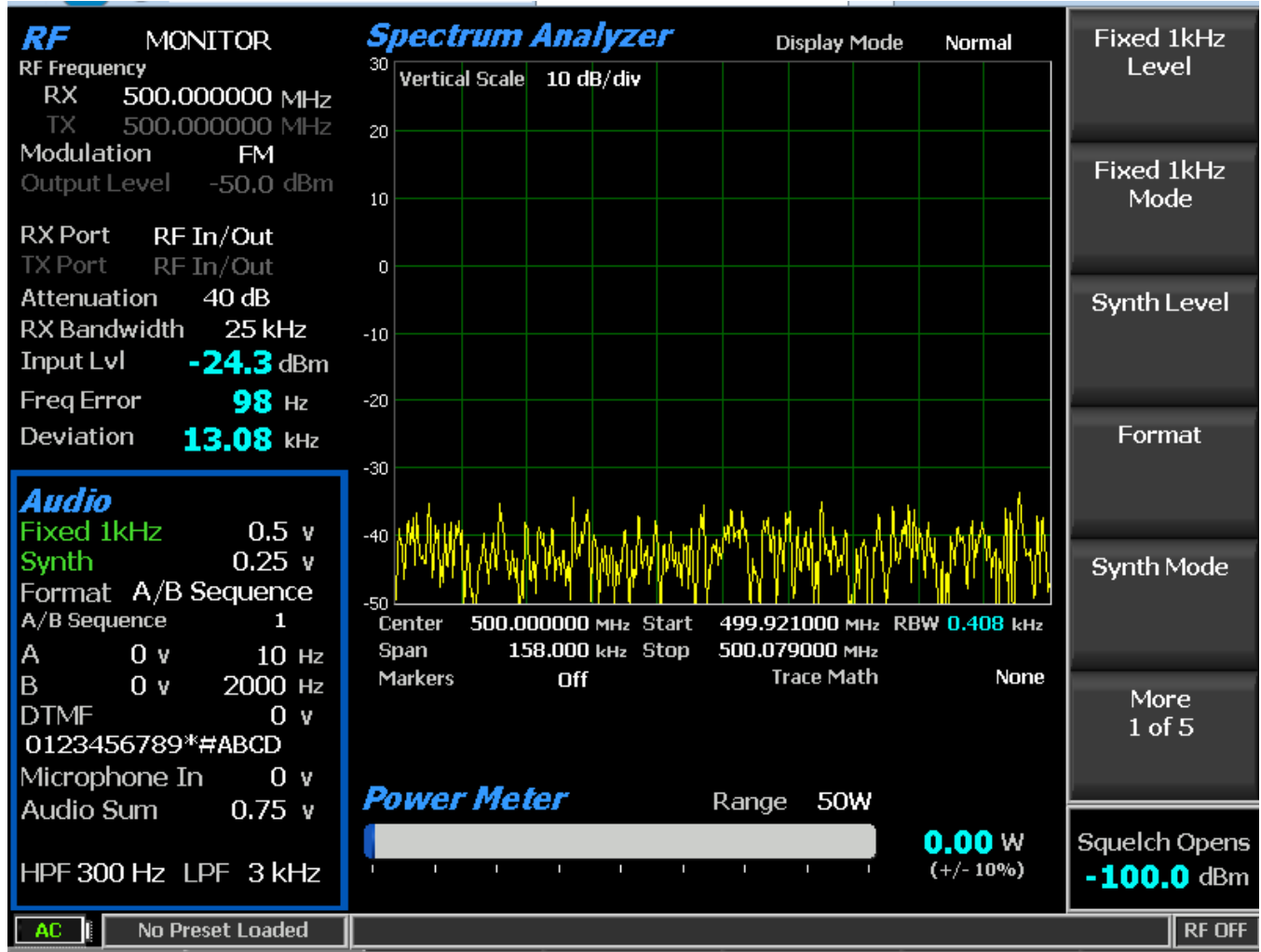

Figure 3.2.4.1-1 Audio Zone submenu in Monitor Mode

2.2.3.2 Common Audio Settings for the Audio Zone submenu

Fixed 1kHz Level

This setting adjusts the fixed 1 kHz tone generator amplitude from 0 to 8V Peak in a data entry window using the arrow keys, keypad, or spin knob. Pressing Enter completes the change, and Esc cancels the entry.

Fixed 1 kHz Mode

This setting activates a horizontal submenu with an Off or Continuous selection for the 1 kHz tone generator. When the tone is activated, the Fixed 1kHz field is highlighted in green.

Synth Level

This setting adjusts the synthesized audio generator amplitude from 0 to 8V Peak in a data entry window using the arrow keys, keypad, or spin knob. This is an independent generator used for encoded audio such as PL, DPL, A/B Sequence, etc.

Synth Format

This setting activates a horizontal submenu with selections for the Synth encoding format – PL, DPL, DPL Invert, A/B Sequence, 5/6 Tone, POCSAG, and General Sequence (see Figure 3.2.4.2-1). Selecting the format makes it the active encoding type for the audio synthesizer. **Note:** See paragraph 3.2.4.3 for specific submenu selections for these formats.

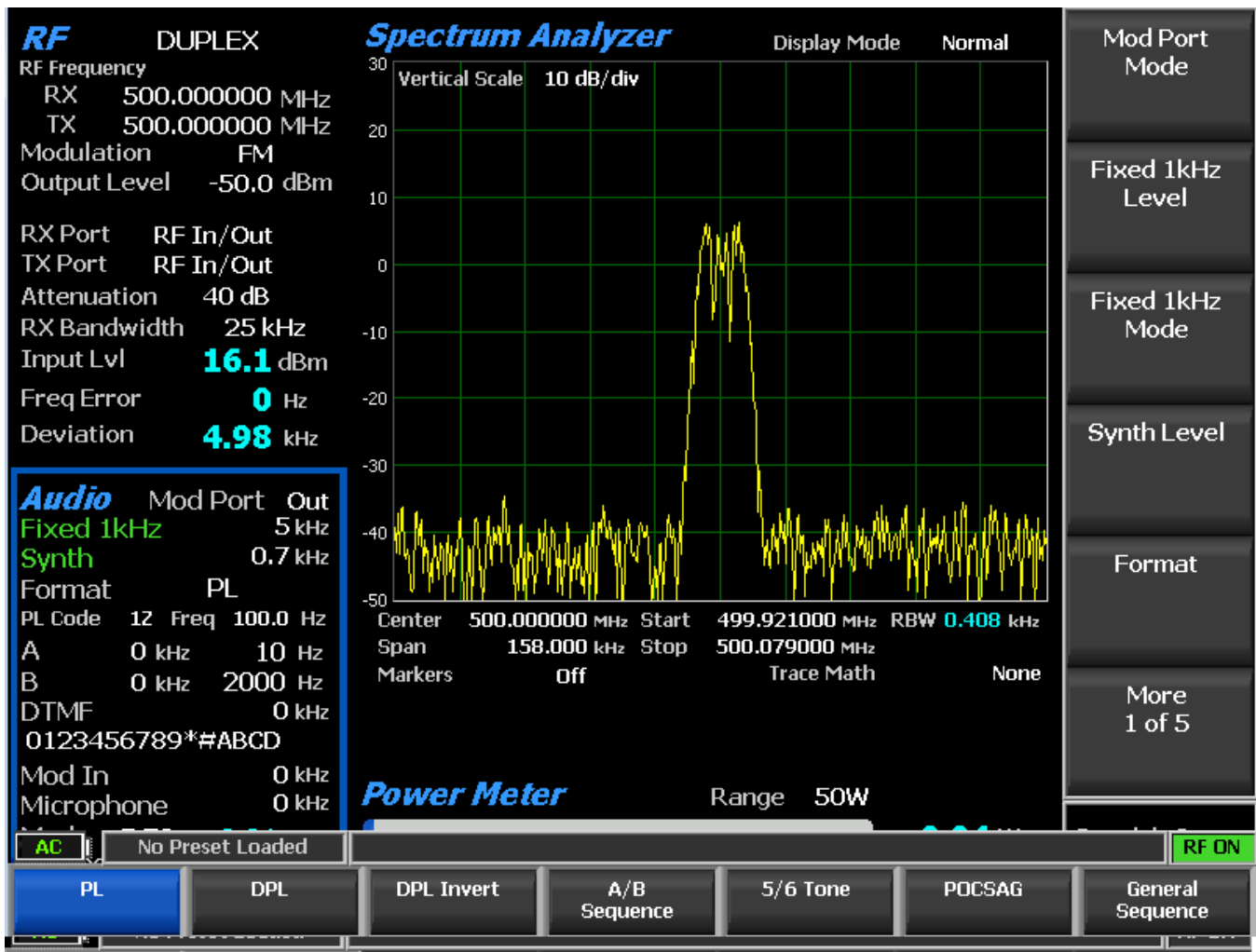

Figure 3.2.4.2-1 Format submenu in Audio Zone

Synth Mode

This key activates a horizontal submenu with an Off or Continuous selection for the Synth generator.

Tone A Level

This key adjusts the “A” variable tone generator amplitude from 0 to 8V Peak in a data entry window using the arrow keys, keypad, or spin knob. Pressing Enter completes the change, and Esc cancels the entry.

Tone A Frequency

This selection adjusts the “A” variable tone generator frequency from 0 to 19999 Hz in a data entry window using the arrow keys, keypad, or tuning knob. Pressing Enter completes the change, and Esc cancels the entry.

Tone A Mode

This selection activates a horizontal submenu with an Off or Continuous selection for the Tone A generator.

Tone B Level

This selection adjusts the “B” variable tone generator amplitude from 0 to 8V Peak in a data entry window using the arrow keys, keypad, or spin knob. Pressing Enter completes the change, and Esc cancels the entry.

Tone B Frequency

This selection adjusts the “B” variable tone generator frequency from 0 to 19999 Hz in a data entry window using the arrow keys, keypad, or tuning knob. Pressing Enter completes the change, and Esc cancels the entry.

Tone B Mode

This selection activates a horizontal submenu with an Off or Continuous selection for the Tone B generator.

DTMF Level

This selection adjusts the DTMF (Dual Tone Multi-frequency) tone generator amplitude from 0 to 8V Peak in a data entry window using the arrow keys, keypad, or spin knob. Pressing Enter completes the change, and Esc cancels the entry. DTMF is used for testing telephone-interfaced systems.

DTMF Mode

This selection activates a horizontal submenu with an Off, Continuous, or Burst selection for the DTMF tone generator.

DTMF Code

This key enters a DTMF Code sequence in a data entry window using the alphanumeric keypad. The Left/Right (◀▶) keys move the highlight to the desired field. The code may be entered several ways.

The Up/Down (▲ ▼) keys or spin knob cycles the highlighted field through the entire DTMF Code table. Pressing the alphanumeric keypad allows direct numeric entry, and alpha characters are entered by cycling through repeated presses of the appropriate numeric key.

DTMF Table

This selection activates soft keys and a table that provide more control when generating a DTMF Code sequence (see Figure 3.2.4.2-2). In addition to the DTMF Code data entry window, other selections permitting adjustment of the Tone Duration and Inter-digit Delay are available. A Single Digit mode also allows single key press tone generation similar to a telephone keypad.

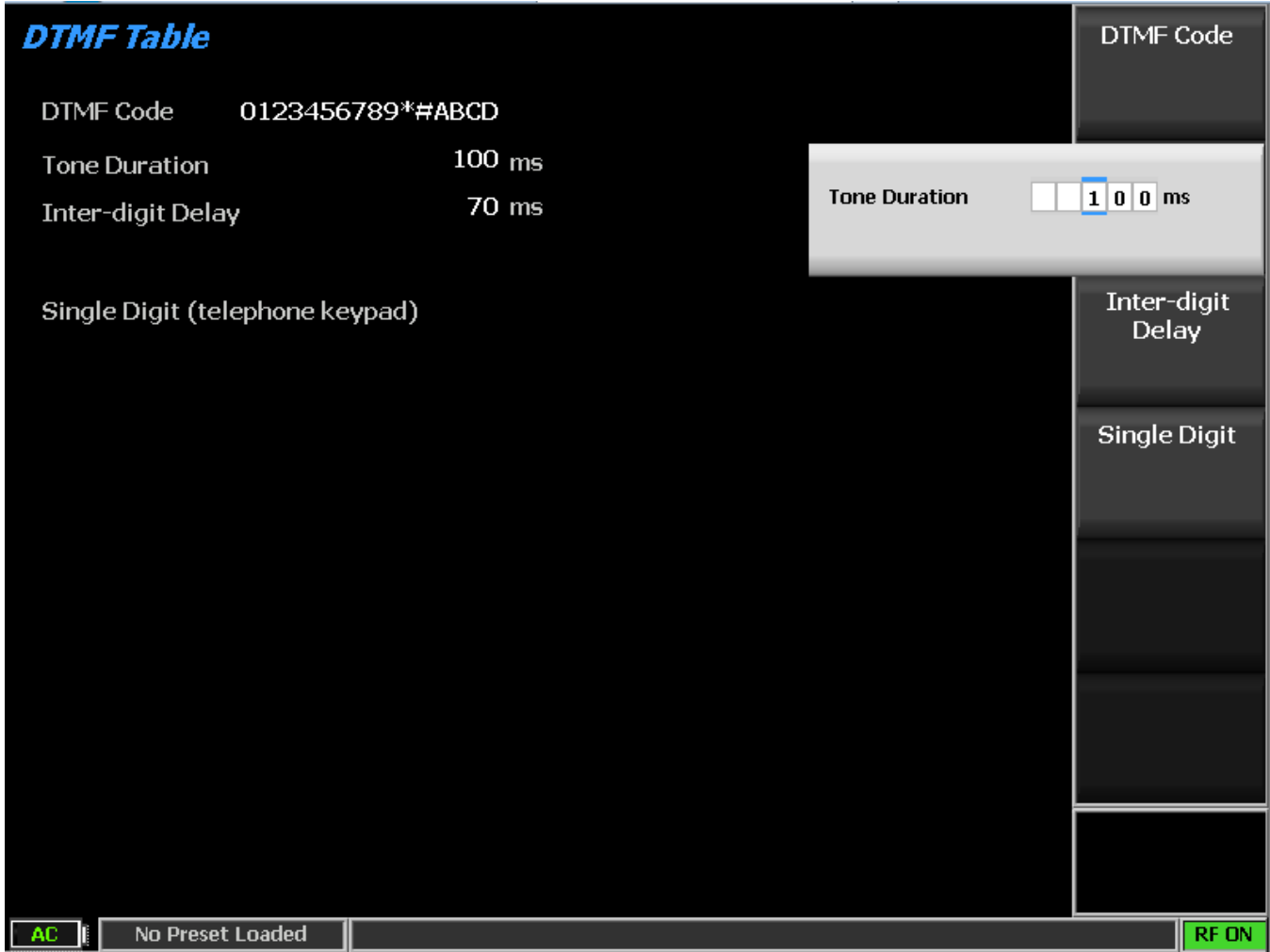

Figure 3.2.4.2-2 DTMF Table providing additional code sequence control

Microphone Mode

This selection enables or disables modulation from an external microphone attached to the Mic In port of the R8100. **Note:** Pressing the PTT button on the external microphone switches the R8100 into Generate Mode. Modulation from the microphone is applied to the carrier when the mode is set to Continuous.

Microphone Level

This selection sets the modulation level for the external microphone attached to the R8100. The displayed units reflect the modulation mode chosen in the RF Zone, either deviation in kHz for FM or % modulation for AM.

High Pass Filter

This setting activates a horizontal submenu with audio filter selections that determine the high pass frequency for the R8100's baseband response to recovered audio. The "cut-on" frequency selections are 5 Hz, 300 Hz, and 3 kHz. This setting is used in conjunction with the Low Pass Filter to determine the audio pass band for the R8100 baseband circuitry.

Low Pass Filter

This setting activates a horizontal submenu with audio filter selections that determine the low pass frequency for the R8100's baseband response to recovered audio. The "cut-off" frequency selections are 300 Hz, 3 kHz, and 20 kHz. This setting is used in conjunction with the High Pass Filter to determine the audio pass band for the R8100 baseband circuitry.

Note: *For best audio and measurement quality, always set an audio pass band no wider than necessary for the signal of interest. Example: A typical two-way radio audio pass band is 300 Hz to 3 kHz. Pass bands wider than necessary allow more noise in the measurement and degrade the audio quality and the readings for deviation, frequency error, SINAD, etc. The default settings for the R8100 High and Low Pass filters are 300 Hz and 3 kHz respectively.*

2.2.3.3 Settings for PL, DPL, DPL Invert A/B Sequence, 5/6 Tone, POCSAG and General Sequence Formats

The following settings appear in Audio Zone submenu pages when specific encoding formats are chosen in the Format horizontal menu (see Figure 3.2.4.2-1).

PL Table (displayed in Audio Zone submenu when synthesizer Format selected is PL)

Selecting PL Table activates a selection table Motorola Private-Line tone-coded squelch signaling and provides a listing of valid codes/frequencies (see Figure 3.2.4.3-1). To scroll through the codes and associated frequencies, use the Up/Down (▲▼) and Left/Right (◀▶) keys. Then, press Enter to complete the entry. Choosing a blank field removes PL coding from the Audio Sum. For valid codes, see Table B-3 in Appendix B.

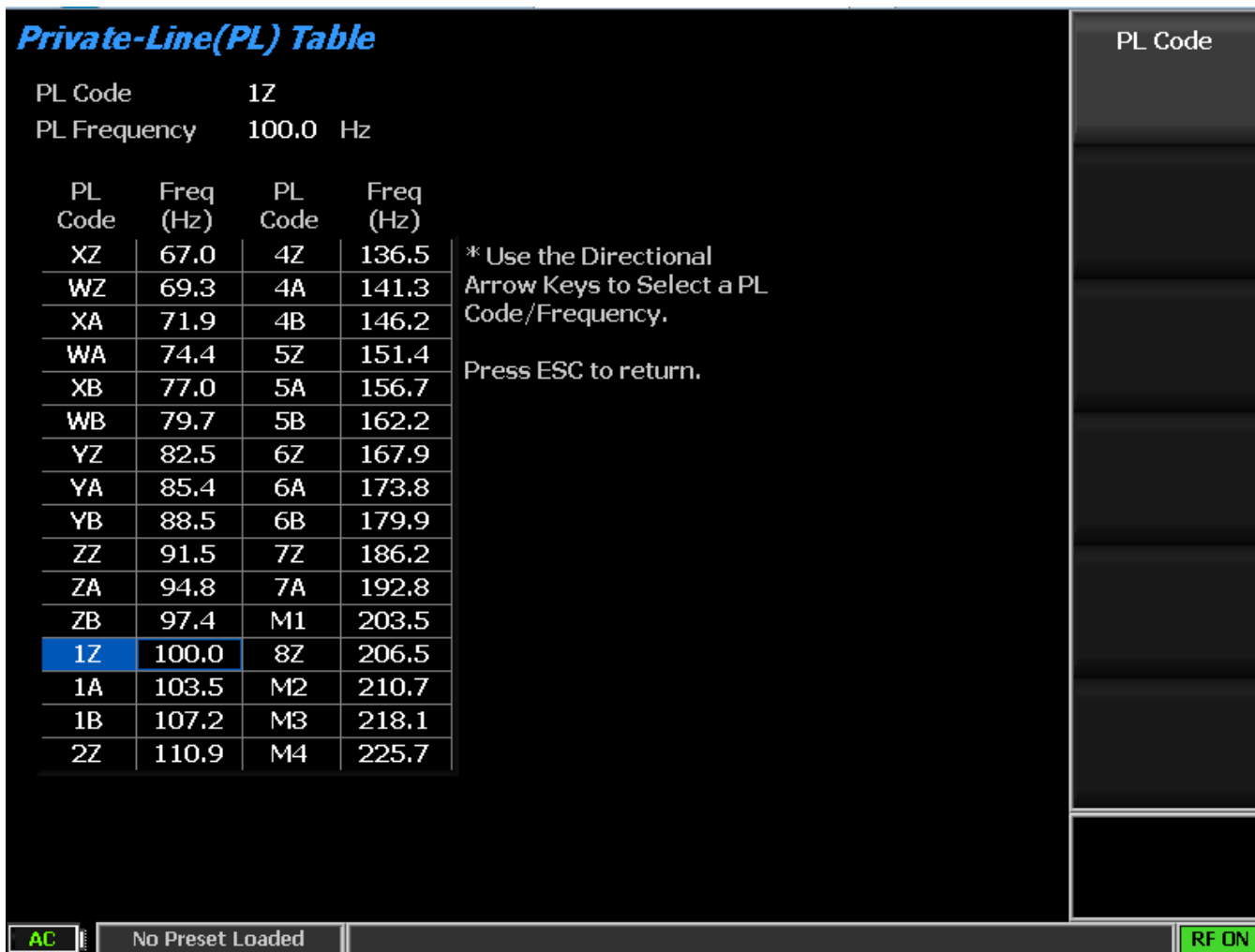

Figure 3.2.4.3-1 PL Table showing highlighted entry code

DPL Code (displayed when synthesizer Format selected is DPL or DPL Invert)

This selection activates a data entry window to enter codes for the Motorola Digital Private-Line coded squelch signaling format. Code entries are made using the cursor control, numeric keypad, and spin knob. See Table B-5 in Appendix B for a selection table with a listing of valid DPL codes.

A/B Sequence (displayed when synthesizer Format selected is A/B Sequence)

This soft key brings up a horizontal menu to select one of four timing sequences for the two-tone sequential paging format. The sequences are programmed and appear in the A/B Sequence Table (see next setting).

A/B Sequence Table (displayed when synthesizer Format selected is A/B Sequence)

This soft key activates a programming table for the two-tone sequential paging format (see Figure 3.2.4.3-2). The A/B Sequence encoding mode uses the Tone A and Tone B generators and one of four selectable timing sequences determined by the Sequence soft key. Sequences 1 and 2 utilize fixed timing for standard "tone" and "tone/voice" pagers, while sequences 3 and 4 may be customized through numeric entries by the user. When the Up/Down (▲▼) keys highlight the programmable sequences (3 and 4), a new

submenu appears as shown in Figure 3.2.4.3-3. The tone frequencies, durations, and delays are entered using this submenu.

A/B Sequence Table

Sequence # 1

Seq #	Tone A Dur (Sec)	Delay (Sec)	Tone B Dur (Sec)	Delay (Sec)
1	0.40	0.00	0.80	1.30
2	1.00	0.00	3.00	1.30
3	0.00	0.00	0.20	0.10
4	0.99	5.01	9.00	0.00

Tone
Tone & Voice
* Use the Directional Arrow Keys or change the Sequence # to select a Sequence to edit.

Tone A Frequency 10 Hz
Tone B Frequency 2000 Hz

Sequence
Tone A Frequency
Tone B Frequency

AC No Preset Loaded RF ON

Figure 3.2.4.3-2 A/B Sequence table showing highlighted sequence

A/B Sequence Table

Sequence # 4

Seq #	Tone A Dur (Sec)	Delay (Sec)	Tone B Dur (Sec)	Delay (Sec)
1	0.40	0.00	0.80	1.30
2	1.00	0.00	3.00	1.30
3	0.00	0.00	0.20	0.10
4	0.99	5.01	9.00	0.10

Tone
Tone & Voice

* Use the Directional Arrow Keys
or change the Sequence # to
select a Sequence to edit.

Tone A Frequency 10 Hz
Tone B Frequency 2000 Hz

Sequence

Sequence 4
Tone A
Duration

Sequence 4
Tone A Delay

Sequence 4
Tone B
Duration

Sequence 4
Tone B Delay

More
1 of 2

AC No Preset Loaded RF ON

Figure 3.2.4.3-3 A/B Sequence table submenu for user programmable entries

5/6 Tone (displayed when synthesizer Format selected is 5/6 Tone)

Selecting 5/6 Tone activates a data entry window and horizontal menu to enter tones for the 5/6 Tone paging format (see Figure 3.2.4.3-4). Tone entries are made using the cursor control, numeric keypad, and spin knob. See Table B-4 in Appendix B for a selection table with a listing of valid 5/6 Tone tones.

The first digit preceding the hyphen is the preamble tone for activating one of ten battery-saver groups. The R-Repeat key or “R” tone is used in place of a repeated digit. After hearing the tone, the operator may assume that the prior digit is being transmitted again. If the digit is repeated a third time, the original tone is transmitted. A sixth or “X” tone is optional for pagers that support this function. The “X” tone indicates that a different beep pattern is used in place of that used for the standard 5 tone response. Pressing the 6-Tone soft key adds the “X” tone to the transmission.

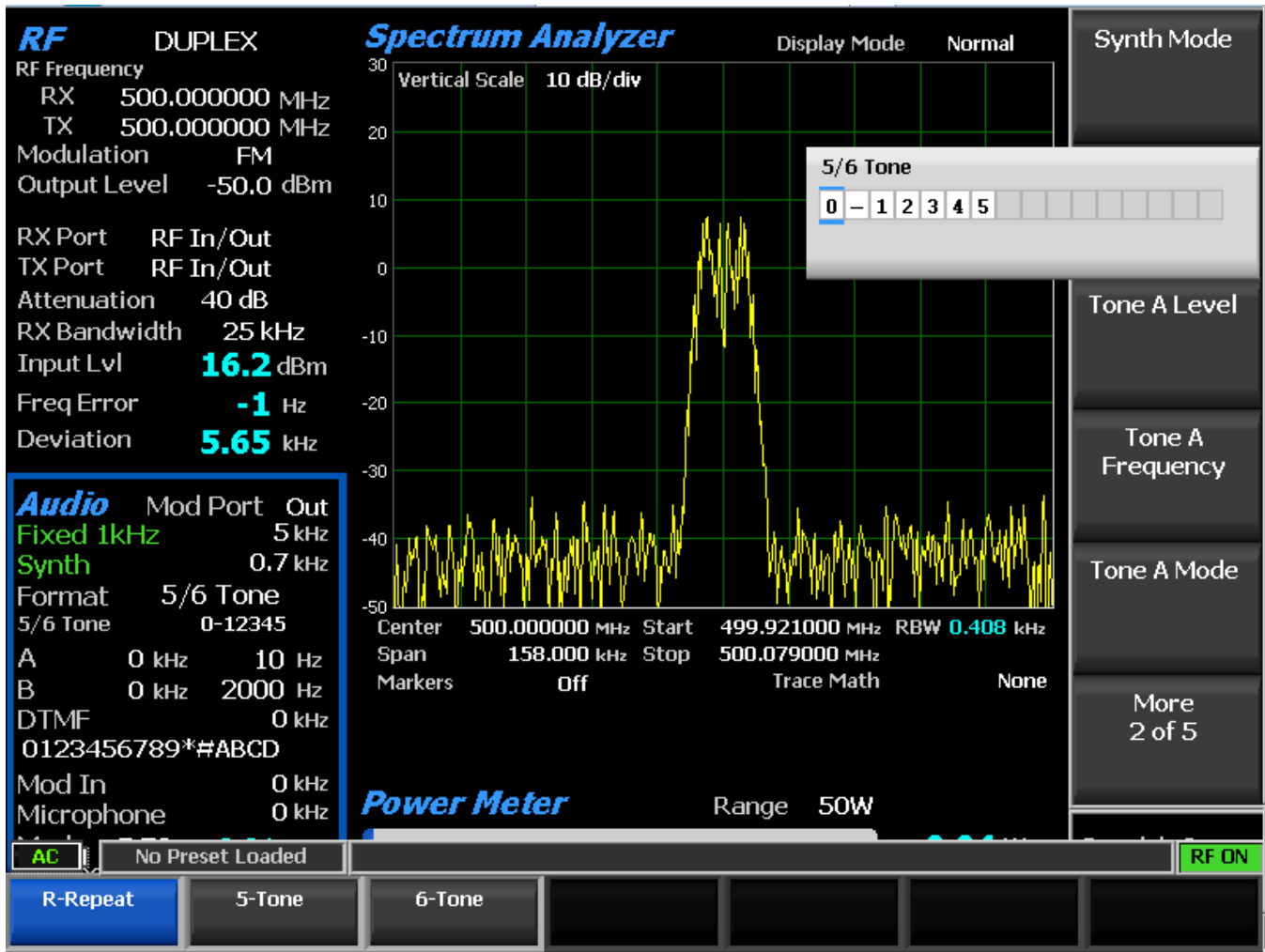

Figure 3.2.4.3-4 5/6 Tone entry submenu

POCSAG Message (displayed when synthesizer Format selected is POCSAG)

This soft key brings up a horizontal menu to select one of eight transmission strings under the Numeric or Alphanumeric POCSAG formats. These include: Tone Only, Numeric number, Numeric set, Alphanumeric upper case, Alphanumeric lower case, Alphanumeric special character, Numeric custom and Alphanumeric custom.

POCSAG Table (displayed when synthesizer Format selected is POCSAG)

This key activates a submenu with a programming table for the POCSAG (ITU-R M.584) digital paging format (see Figure 3.2.4.3-5).



Figure 3.2.4.3-5 POCSAG Table submenu

2.2.3.3.1 Settings in the POCSAG Table submenu

Synth Mode

This setting activates a horizontal submenu to select Off, Continuous, or Burst Mode for the POCSAG synthesizer.

Capcode

Select the Capcode for the specific pager from 0 through 2097151 using arrow keys, keypad, or spin knob.

Function Bits

This setting activates a horizontal submenu for choosing the function bits indicating the type and format of the message data page (00; 01; 10; 11).

POCSAG Message

Use the arrow keys or spin knob to select one of eight transmission strings under the Numeric or Alphanumeric POCSAG formats. Six factory sets and two custom messages exist. **Note:** *Anytime the POCSAG Table submenu is displayed, the Up/Down (▲▼) keys may be used to highlight the Msg/String table entries desired for the POCSAG Msg. Highlighting the NumericCust or AlphaNumCust selections allows editing of the respective custom Numeric or Alpha-numeric strings. Up to 16 characters may be entered. Entered NumericCust and AlphaNumCust strings are truncated or expanded to match Message Length.*

Tone Only: <empty string>

NumericNum: 0123456789

NumericSet: The used characters in the Numeric set. See Table B-7.

AlphaNumUC: ABCDEFGHIJKLMNOPQRSTUVWXYZ

AlphaNumLC: abcdefghijklmnopqrstuvwxyz

AlphaNumSP: space!"#\$%&'()*+,-./:;<=>?@[\\]^_`{|}~

NumericCust: Anything in the Numeric set. See Table B-7.

AlphaNumCust: Anything in the Alpha-numeric set. See Table B-8

Message Length

Use the arrow keys, spin knob, or numeric pad to set the message length from 0 to 60 characters.

Data Rate

Use the arrow keys, spin knob, or numeric pad to set the communication data rate from 400 to 4800 bps.

Polarity

This soft key activates a horizontal submenu for choosing the polarity of the POCSAG data stream, either Normal or Inverted. When set to Normal, a logic high (1) results in a more positive frequency deviation in FM mode. A logic low (0) results in a more negative frequency deviation in FM mode. When set to Inverted, a logic high (1) results in more negative frequency deviation in FM mode. A logic low (0) results in a more positive frequency deviation in FM mode.

Error Bit

Use the arrow keys, spin knob, or numeric pad to set the error bit at the specified location in the POCSAG page bit stream. The error bit allows targeted insertion of an error into the page to test a POCSAG decoder's error correction capability. The setting toggles the Error Bit in the POCSAG page bit stream, where the bit stream uses a 1-based index. If Error Bit is set to 0 (default), no bits are toggled. If Error Bit is set ≥ 1 , then bit stream (Error Bit) is toggled.

2.2.3.3.2 Settings in the General Sequence Table submenu

Code Sequence (displayed when synthesizer Format selected is General Sequence)

This setting activates a data entry window and horizontal menu for entering an audio tone sequence for encoding on either the RF carrier or Mod Out port. Each entry can be one of 20 Tone Codes (0 to 9 and A to J) with the frequency, duration, and post tone delay specified in the General Sequence Table. Tone

entries are made using the ▲▼ (Up/Down) and ◀▶ (Left/Right) keys, numeric keypad, and spin knob. “Clear to End” clears the highlighted entry and all others to the right.

General Sequence Table (displayed when synthesizer Format selected is General Sequence)

This setting displays a programming table for the General Sequence encoder (see Figure 3.2.4.3-6). The table is populated with 20 Tone Codes (0 to 9 and A to J) with preset data for frequency, duration, and post-tone delay. The selected Tone Standard determines the preset data for each tone code. Regardless of the standard selected, each Tone Code can be edited for the current operating session or saved as a customized Sequence.

General Sequence Table

Code 0123456789ABCDEFGHIJ Same as in Audio Zone Mode **Off**

Duration 0123456789ABCDEFGHIJ Changeable only from this screen } Sync Seq Data to Code Entry **Yes**

Delay 0123456789ABCDEFGHIJ Changeable only from this screen }

* Use the Directional Arrow Keys to select a Tone Code to edit.

Code	Freq (Hz)	Dur (sec)	Post-tone Delay(sec)
0	1981.0	0.100	0.00
1	1124.0	0.100	0.00
2	1197.0	0.100	0.00
3	1275.0	0.100	0.00
4	1358.0	0.100	0.00
5	1446.0	0.100	0.00
6	1540.0	0.100	0.00
7	1640.0	0.100	0.00
8	1747.0	0.100	0.00
9	1860.0	0.100	0.00
A	2400.0	0.100	0.00
B	930.0	0.100	0.00
C	2247.0	0.100	0.00
D	991.0	0.100	0.00
E	2110.0	0.100	0.00
F	1055.0	0.100	0.00
G	0000.0	0.000	0.00
H	0000.0	0.000	0.00
I	0000.0	0.000	0.00
J	0000.0	0.000	0.00

0 Selected Tone Code

Tone Standard CCIR 1

Group Tone

Reset Tone

Repeat Tone

Code Sequence

Select Tone Standard

Synth Mode

Tone Frequency

Tone Duration

More 1 of 2

AC No Preset Loaded RF ON

Figure 3.2.4.3-6 General Sequence Table submenu

Code Sequence (also appears in Audio Zone submenu)

This setting activates a data entry window and horizontal menu for entering a tone sequence. Each entry can be one of 20 Tone Codes (0 to 9 and A to J) with the frequency, duration, and post tone delay specified in the General Sequence Table. The Tone Code entries are made using the ▲▼ (Up/Down) and ◀▶

(Left/Right) keys, numeric keypad, and spin knob. “Clear to End” clears the highlighted entry and all others to the right.

Select Tone Standard

Choose which Tone Standard is used for the preset Tone Code entries on the General Sequence table. “None” populates the table with the factory default values shown in Figure 3.2.4.3-6. The remaining selections are SelCall (Selective Calling) tone standards: CCIR1, CCIR2, PCCIR, CCITT, EEA, EIA, Euro, NATEL, MODAT, ZVEI1, ZVEI2, ZVEI3, PZVEI, DVZEI, and PDZVEI. Regardless of which standard is chosen, each Tone Code can be selected and edited by positioning the blue highlighting arrow using the Up/Down (▲▼) keys or spin knob. Edited tables can be saved as a user-defined Sequence Definition. Reselecting and entering any Tone Standard restores the original table entries.

Synth Mode (also appears in Audio Zone submenu)

This setting activates a horizontal submenu with an Off, Continuous, or single Burst selection for the Synth generator transmitting the tone. The status of the Synth Mode is shown in the “Mode” field.

Tone Frequency

This setting activates a data entry window for customizing the Tone Frequency of the highlighted Tone Code. Highlight a Tone Code to edit with the blue selection arrow using the Up/Down (▲▼) keys. The adjustment range is from 0 to 20 kHz in 0.1 Hz steps.

Tone Duration

This setting activates a data entry window for customizing the Tone Duration of the highlighted Tone Code. Highlight a Tone Code to edit with the blue selection arrow using the Up/Down (▲▼) keys. The adjustment range is from 0 to 10 seconds in 0.001 second steps.

Post Tone Delay

This setting activates a data entry window for customizing the duration of the delay following the transmitted tone. Highlight a Tone Code to edit with the blue selection arrow using the Up/Down (▲▼) keys. The adjustment range is from 0 to 10 seconds in 0.01 second steps.

Save Sequence Definition

This setting activates a data entry window for entering a title and saving the user-customized General Sequence Table. Alphanumeric entries are made using the ▲▼ (Up/Down) and ◀▶ (Left/Right) keys, numeric keypad, and spin knob.

Load Sequence Definition

Choose a previously saved Sequence Definition in a selection window using the ▲▼ (Up/Down) keys and spin knob; then press Enter.

Export Sequence Definition

Save a Sequence Definition stored on the R8100 to an external USB Flash Drive. Choose it in a selection window using the ▲▼ (Up/Down) keys or spin knob; then press Enter.

Delete Sequence Definition

Delete a Sequence Definition stored on the R8100. Choose it in a selection window using the ▲▼ (Up/Down) keys or spin knob; then press Enter.

Sync to Code Entry

When set to “Yes,” any Tone Code alphanumeric value entered into the Code Sequence field is initially populated into the associated position in the Duration and Delay Sequence fields; Figure 3.2.4.3-6 shows an example of this. This matches the frequency, duration, and delay values for each tone in the Code Sequence to that shown on the Tone Code line entry in the table. If desired, these initially synchronized Duration and Delay sequence entries can be changed to other values from the table. When set to “No,” the entries for the Duration and Delay Sequences are set independently of the Code Sequence, with duration and delay values from any Tone Code on the table. Figure 3.2.4.3-6 shows an example of this.

Duration Sequence

This setting activates a data entry window and horizontal menu for entering a duration sequence. The duration value from any of the 20 Tone Codes (0 to 9 and A to J) specified in the General Sequence Table can be used. The Tone Code entries are made using the ▲▼ (Up/Down) and ◀▶ (Left/Right) keys, numeric keypad, and spin knob. “Clear to End” clears the highlighted entry and all others to the right. Each entry in the Duration Sequence is paired in positional order with the associated entry in the Code Sequence, which provides the tone frequency, and the Delay Sequence, which provides the post tone delay. A duration of zero is used for Code Sequence entries that do not have an associated Duration Sequence entry. Duration Sequence entries that do not have an associated Code Sequence entry are ignored.

Delay Sequence

This setting activates a data entry window and horizontal menu for entering a post tone delay sequence. The delay value from any of the 20 Tone Codes (0 to 9 and A to J) specified in the General Sequence Table can be used. The Tone Code entries are made using the ▲▼ (Up/Down) and ◀▶ (Left/Right) keys, numeric keypad, and spin knob. “Clear to End” clears the highlighted entry and all others to the right. Each entry in the Delay Sequence is paired in positional order with the associated entry in the Code Sequence, which provides the tone frequency, and the Duration Sequence, which provides the tone duration. A delay of zero is used for Code Sequence entries that do not have an associated Delay Sequence entry. Delay Sequence entries that do not have an associated Code Sequence entry are ignored.

2.2.3.4 Setting audio operating parameters in Generator Mode

The audio settings in Generator Mode replicate those in Monitor Mode with two key differences. In Generator Mode, the audio signal is simultaneously applied as a modulation to the RF carrier and the Mod In/Out connector. Also, Mod Sum level is shown in units of FM deviation (kHz) or AM modulation depth (%), depending on the Modulation Type setting in the RF Zone (see Figure 3.2.4.4-1).

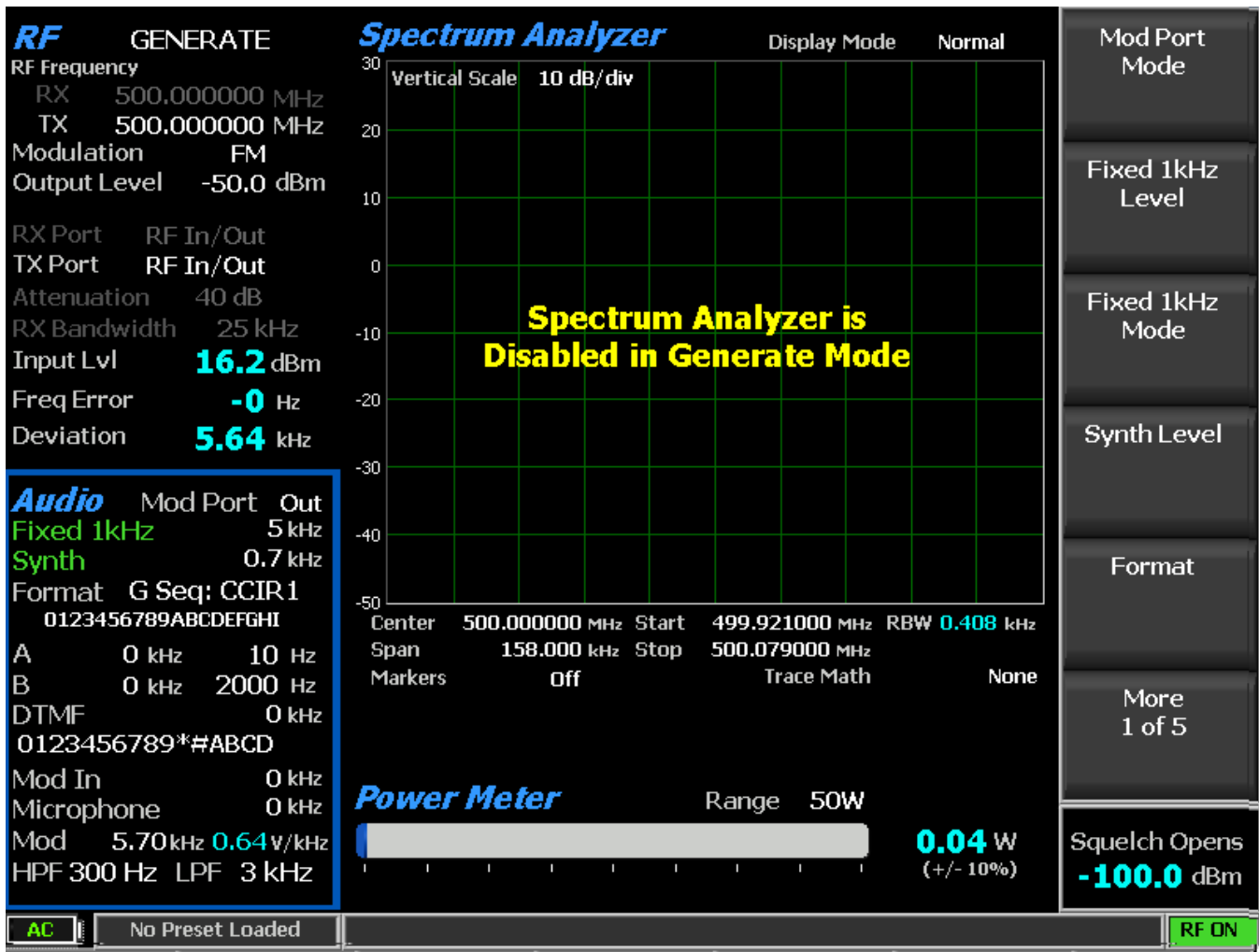

Figure 3.2.4.4-1 Audio Zone submenu in Generator Mode

The additional submenu choices for the Audio Zone in Generate Mode are as follows:

Mod Port Mode

This soft key determines the signal routing for the Mod In/Out port on the front panel. Choosing “In” directs an externally applied signal to the modulation circuitry of the R8100. When switched to “Out,” internally-generated audio modulation is routed to the Mod In/Out port for use by an external radio or instrument. **Note:** Remove voltage sources before selecting “Out.” If input voltage is detected at the port, the “Out” selection is ignored, and an alert is displayed at the bottom of the display.

Mod In Port Level

This key sets the modulation level for the external signal applied to the Mod In/Out port on the R8100. The displayed units reflect the modulation mode chosen in the RF Zone, either deviation in kHz for FM or % modulation for AM. **Note:** The audio signals must equal +/- 1Vpk to provide a reference for accurate display of the applied modulation level.

CAUTION



Do not exceed +/- 1.5 V_{pk} on the Mod In/Out port or damage may occur to internal circuitry.

Mod In Port Mode

This key activates a horizontal submenu with an Off or Continuous selection for the external signal applied to the Mod In/Out port on the front panel.

2.2.3.5 Setting audio operating parameters in Duplex Mode

The audio settings in Duplex Mode replicate those in Generate Mode (see Section 3.2.4.4).

2.2.4 Display Zone

The R8100 has several graphical displays providing a visual presentation of received RF signal measurements, recovered audio, internally-generated audio, and externally-measured audio signals. These include a Spectrum Analyzer, Modulation Scope, and Oscilloscope, along with Bar Graphs for RF signal deviation, frequency error and input level. The displays are accessed from the main menu with the Display Zone soft key (see Figure 3.2.5-1). **Note:** *General Sequence appears as a display choice if General Sequence is enabled in the Meter Zone.*

The vertical submenu selections below the “Select Display” soft key change depending on the chosen display - in this case the Spectrum Analyzer is highlighted in blue on the “Select Display” horizontal menu. The vertical soft key menu now has several pages of Spectrum Analyzer settings including Center Frequency, Span, Start and Stop frequencies, etc.

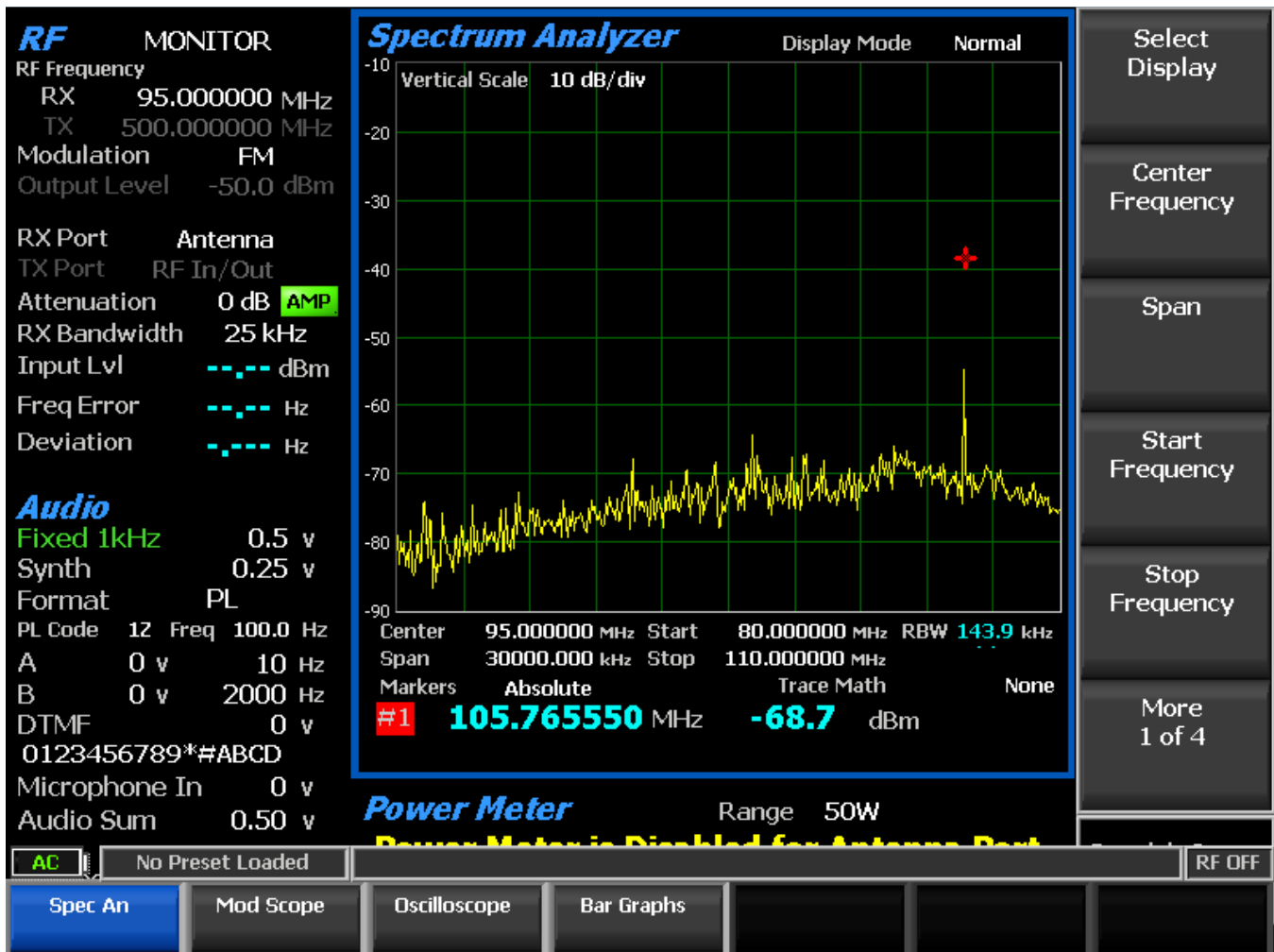

Figure 3.2.5-1 Display Zone submenu after Select Display soft key press

The following sections detail the submenu and soft key selections for the graphical displays on the R8100 analyzer.

2.2.4.1 Spectrum Analyzer settings

Access the Spectrum Analyzer using the Select Display soft key to bring up the horizontal submenu display choices. The available adjustments are as follows:

Center Frequency

This soft key sets the center frequency from 250 kHz to 3 GHz for the Spectrum Analyzer in a data entry window using the arrow keys, keypad, or tuning knob. Pressing Enter completes the change, and Esc cancels the entry.

Span

This key sets the total frequency window displayed on the Spectrum Analyzer in MHz. The Span entry total is automatically split evenly on each side of the current center frequency. **Note:** Receiver-

demodulated audio is inhibited at spans above 158 kHz. Switch display to Mod Scope or use Demod at Marker function to hear audio at wider spans.

Start Frequency

This soft key sets the display start frequency in MHz. Use with the Stop Frequency to establish a desired frequency range for the Spectrum Analyzer display. The R8100 automatically centers the frequency display midway between Start and Stop frequencies.

Stop Frequency

This key sets the display stop frequency in MHz. Use with the Start Frequency to establish a desired frequency range for the Spectrum Analyzer display. The R8100 automatically centers the frequency display midway between Start and Stop frequencies.

Reference Level

This key adjusts the maximum level for the vertical scale of the display (top line) from -120 dBm to +60 dBm in 1 dB increments.

Vertical Scale

This soft key selects the vertical scale resolution for the display's major grid lines from 1 dB/div to 10 dB/div via a horizontal soft key list.

Display Mode

This soft key selects the display presentation with the following horizontal menu choices:

Normal – The display updates continuously.

Freeze – The display provides a snapshot of the current display indication and stops additional updates.

Note: *In Freeze Mode, the R8100 reacquires data and updates the display whenever “Center Marker” or “Center Peak” is pressed.*

Max Hold – The display retains the highest peak signal amplitudes measured during successive sweeps.

Average – The displayed signal amplitudes are a rolling average of the peak amplitudes measured on each successive sweep. The average consists of one to five sweeps, shown beside the mode indication.

Trace Math

This key selects an equation to use for the computation of the spectrum trace (white) from the Display Mode trace and reference trace (cyan). Setting Display Mode to Average minimizes effects of a low level / high variance signal such as the noise floor. **Note:** *The underlying units of the result are no longer dBm but dB for the displayed spectrum and thus marker power.*

The following are horizontal menu choices.

None – This selection hides the reference trace and displays the spectrum resulting from the Display Mode unmodified.

Spec-Ref (log) – This selection displays the difference of the Display Mode spectrum in dBm minus the reference trace in dBm, which normalizes the spectrum to 0 on the Y-axis. Subsequently, spectrum power

is shown on the display and measured by absolute markers relative to the reference trace, i.e. correctly interpreted as dBm above the reference.

|Spec-Ref| (lin) – This choice displays the logarithm of the absolute value of the difference of the Display Mode spectrum in volts² minus the reference trace in volts². **Note:** *Although the absolute value of the difference avoids logarithm of negatives, it has the side effect of increasing the apparent noise power.*

Spec+Ref (lin) – This choice displays the logarithm of the sum of the Display Mode spectrum in volts² plus the reference trace in volts².

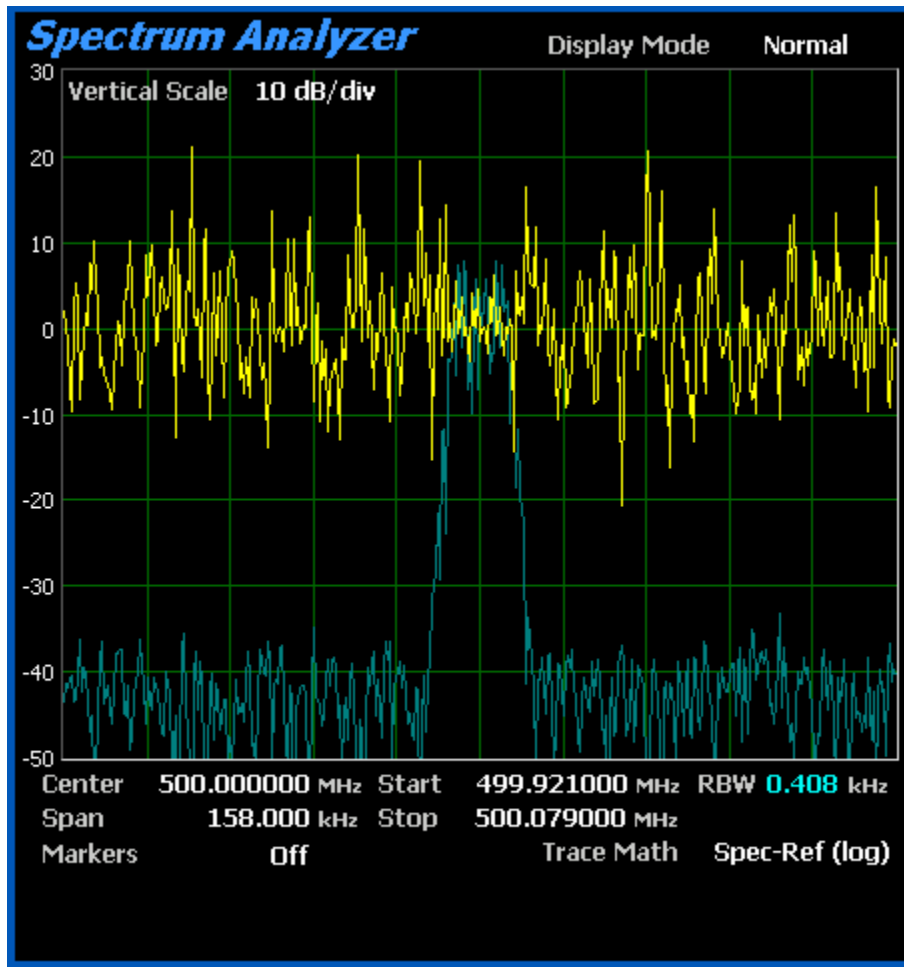

Figure 2.2.4.1-1 Trace Math Display

Set Reference Trace

This key copies the current spectrum trace (white) and shows it in a static trace (cyan) behind the spectrum trace. The trace is copied from what is currently shown, which is after any Display Mode processing as well as Trace Math computations. Therefore, ensure that both of those settings are appropriately set (i.e. Trace Math is None); setting the reference when Trace Math is active may yield incoherent results. Setting Display Mode to Average minimizes effects of a low level / high variance signal such as the noise floor. This static trace is used for computations when a Trace Math equation is specified and may simply be viewed even when one is not. It can be hidden by selecting Trace Math None. **Note:** *System changes that*

may invalidate the reference trace include port, amplification, attenuation, frequency, span, temperature, and calibration.

3 dB Marker

This key selects the 3 dB marker with the following horizontal menu choices:

Off – Function is off.

Frequency – This selection places a marker above and below center frequency where the signal is -3 dB below the peak amplitude measured at center frequency. The upper and lower frequencies are shown on the display.

Delta – This selection places a marker above and below center frequency where the signal is -3 dB below the peak amplitude measured at center frequency. The difference between these two frequencies is shown on the display.

Marker Mode

This mode provides display marker control via a horizontal soft key menu. Markers can be turned off or on with a choice of numeric readout for the signal measurements. “Absolute” provides actual peak readings while “Delta” measures the relative difference of both power and frequency between the markers. **Note:** *Depending on the installed options, up to four markers can be enabled and selected for positioning while in Instrument Mode.*

Find Peak

This selection moves the cursor to the highest signal peak in the display window and provides a numeric readout of the amplitude and frequency.

Toggle Marker

The Toggle Marker cycles through the available markers to select the active one (yellow) for positional adjustment on the display. The active marker is moved using the Left/Right (◀▶) cursor control buttons.

Center Marker

This soft key centers the operating frequency and display of the R8100 Spectrum Analyzer around the frequency of the active marker.

Center Peak

This key centers the operating frequency and display of the R8100 Spectrum Analyzer around the highest peak signal within the display range.

Demod At Marker

When the Marker Mode is Absolute, this function demodulates the carrier and provides audio for the signal at the marker location with the following horizontal menu choices (see Figure 2.2.4.1-2):

Off – Function is off.

Single – This selection provides a one-time demodulation of the carrier signal located at the marker position for a quick listen at the marker frequency. Moving the marker or changing the monitor frequency, mode, or Display Zone selection switches the Demod At Marker function Off.

Continuous – Continuous Mode allows users to move the selected marker to demodulate carriers across the entire displayed spectrum. On full-screen instruments, the user can setup several markers on various peaks and use the marker selection to quickly demodulate and listen to those peaks. Additionally, on the Dual Display, the user can simultaneously view the demodulation scope while tuning the marker positions.

Note: To ensure audio is demodulated, the marker must be close enough to overlap the R8100 Monitor Bandwidth around the carrier frequency. Large Span settings increase marker frequency step size, limiting how close the marker can get to the actual frequency. To minimize step size, use the narrowest span practical when displaying multiple carriers.

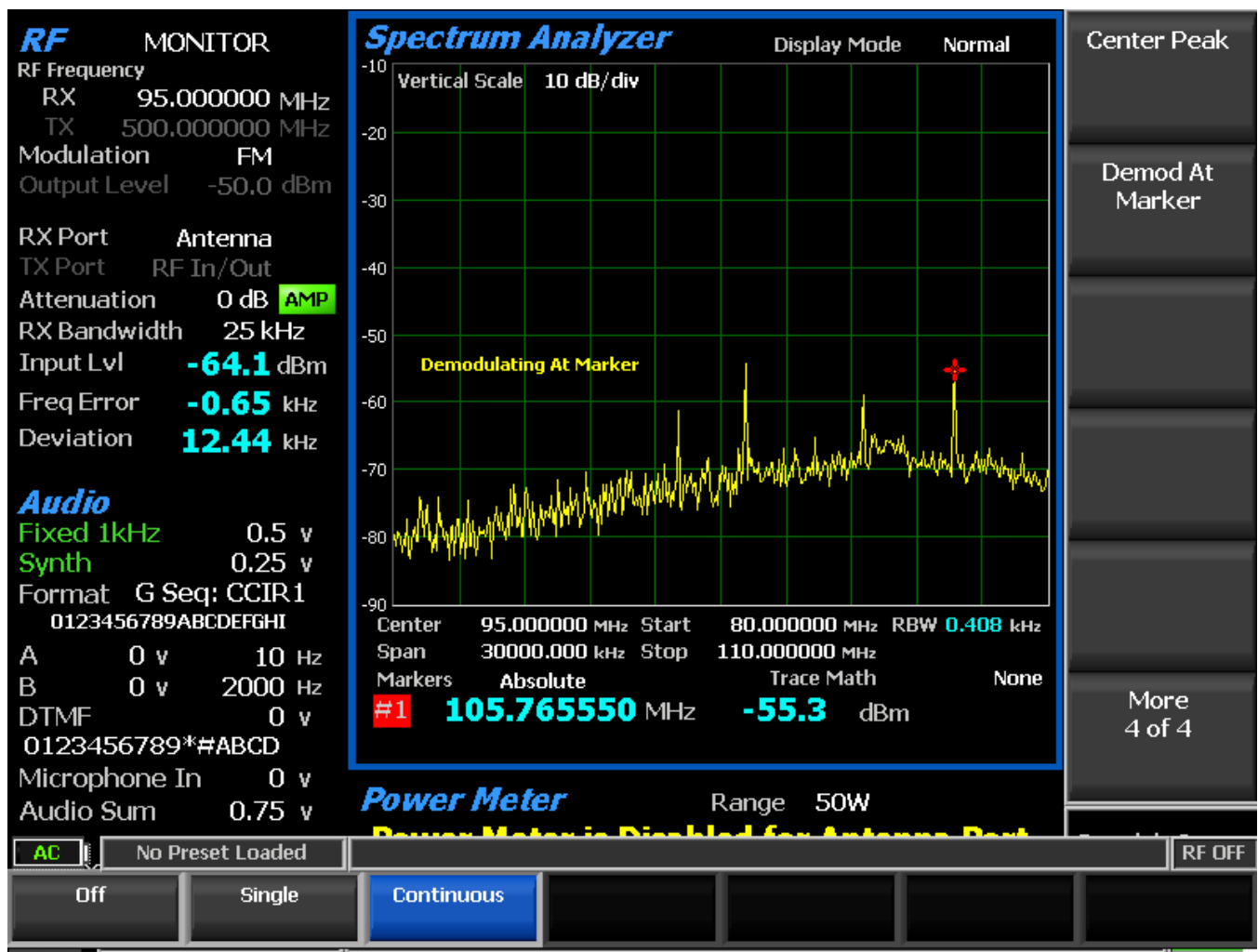

Figure 2.2.4.1-2 Demod At Marker submenu

2.2.4.2 Modulation Scope settings

The Modulation Scope displays the internally-processed RF modulation waveforms. It automatically switches between Generator and Monitor modulation depending on which mode is selected. In Duplex Mode an additional soft key allows manual selection of the Monitor or Generator modulation waveform.

Access the Modulation Scope using the Select Display soft key to bring up the horizontal submenu display choices. The available adjustments are as follows:

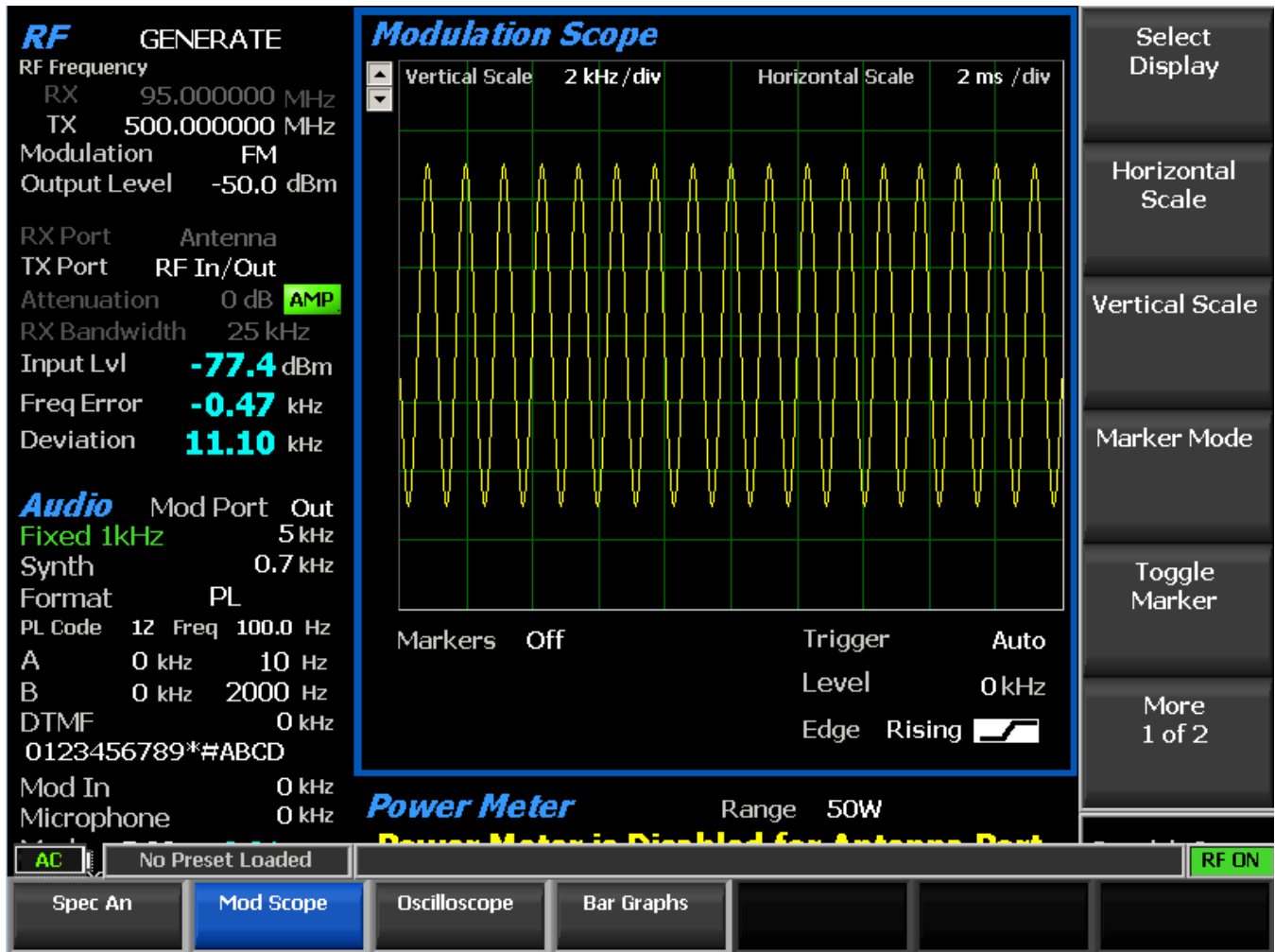

Figure 2.2.4.2-1 Display Zone submenu for the Mod Scope

Vertical Scale

This soft key selects the vertical scale resolution for the display's major grid lines via a horizontal submenu. The display units presented are dependent on the R8100's modulation setting in the RF Zone. For FM Mode the units are in Hz and kHz deviation, ranging from 100 Hz/div to 50 kHz/div. In AM mode the units are in % modulation depth and range from 1%/div to 50%/div.

Horizontal Scale

This soft key selects the horizontal time scale resolution for the display's major grid lines in a dialog entry box using the Up/Down (\blacktriangle / \blacktriangledown) keys or spin knob. The units range from 20 μ S/div to 1 sec/div.

Marker Mode

This soft key provides display marker control via a horizontal soft key menu. Markers can be turned off or on with a choice of numeric readout for the signal measurements as follows:

Delta V – The numeric reading shows the difference in amplitude between marker positions.

Delta T – The numeric reading shows the difference in time between marker positions.

1/DeltaT – The numeric reading shows the inverse of the time difference between markers, which can be used to determine the frequency of a repetitive waveform.

Toggle Marker

This key cycles through the available markers to select the active one (yellow) for positional adjustment on the display. The active marker is moved using the Left/Right (◀▶) cursor control buttons.

Trigger Mode

This key selects the Trigger Mode for the horizontal sweep via a submenu. The choices are as follows:

Auto – If a signal satisfying the Trigger Edge and Trigger Level settings is present, the display will sweep as in Normal Mode. If no signal satisfying the Trigger Edge and Trigger Level settings is present, then the display sweeps continuously until a signal satisfying the settings is acquired.

Normal – The display sweeps only when the input signal satisfies the Trigger Edge and Trigger Level settings.

Single – The display sweeps once after a key press is performed on the Single soft key if the signal satisfies the Trigger Edge and Trigger level settings.

Trigger Level

This key adjusts the signal threshold at which a horizontal sweep is initiated. The soft key activates a numeric entry box, and the Left/Right (◀▶) keys move the highlight over the desired number field. Numeric changes are entered directly using the keypad, in steps with the Up/Down (▲▼) keys, or using the spin knob.

Trigger Position

This key adjusts the amount of pre-trigger waveform displayed on the screen via selections on a horizontal submenu. The choices are 10%, 50%, or 90% of the display allocated to the waveform preceding the trigger threshold.

Trigger Edge

This key determines which waveform edge is used to trigger the modulation scope sweep via selections on a horizontal submenu. The selections are Rising, Falling, or Either.

Scope Mode

This key allows for the selection of the Monitor or Generator modulation waveform in Duplex Mode.

Vertical Position

This key adjusts the vertical position of the waveform on the display using a horizontal submenu. Pressing the Move Up and Move Down soft keys shifts the waveform position by fixed increments.

2.2.4.3 Oscilloscope settings

The R8100 analyzer provides a general-purpose oscilloscope with calibrated vertical input sensitivities and automatic or triggered horizontal sweep rates. Use the scope to analyze waveforms, detect asymmetric modulation or audio distortion, trace signals, and troubleshoot subsystems or circuits. The Meter In port serves as the vertical input for the Oscilloscope.

Access the external Oscilloscope using the Select Display soft key to bring up the horizontal submenu display choices as shown in Figure 3.2.5.3-1. The available adjustments are as follows:

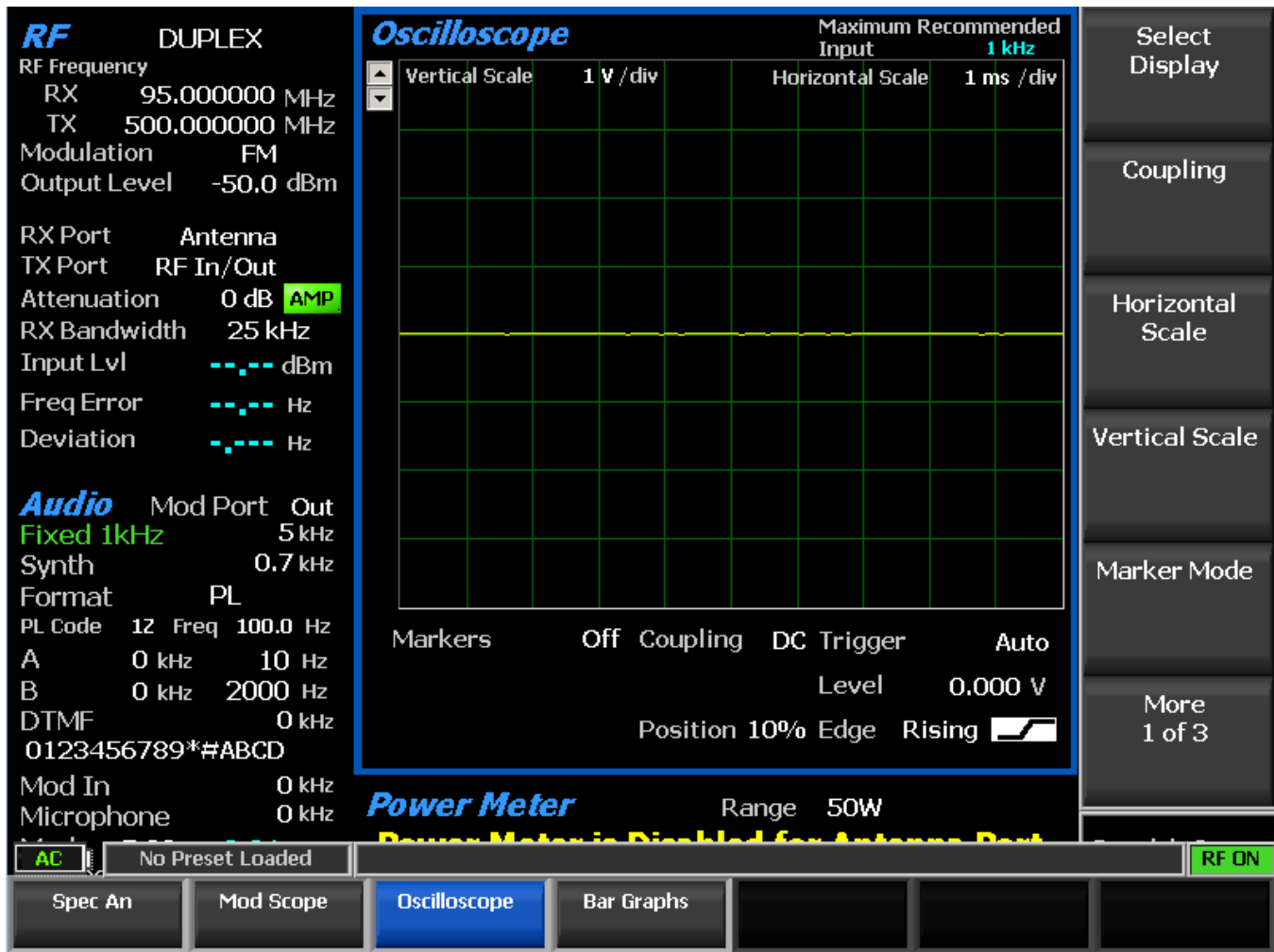

Figure 3.2.5.3-1 Display Zone submenu for the Oscilloscope

Coupling

This key selects the input coupling for the external signal applied to the Meter In port with a user entry window. Choose DC or AC coupling by pressing the Coupling soft key, the Up/Down (\blacktriangle \blacktriangledown) keys, or rotating the spin knob.

Vertical Scale

This soft key selects the vertical scale resolution for the display's major grid lines with a user entry window. The available selections range from 10 mV/div to 25 V/div and can be changed by pressing the Vertical Scale soft key, the Up/Down cursor keys (▲▼), or rotating the spin knob.

Horizontal Scale

This key selects the horizontal time scale resolution for the display's major grid lines in a dialog entry box using the Up/Down (▲▼) keys or spin knob. The units range from 20 uS/div to 1 sec/div.

Note: *Digital oscilloscopes are susceptible to aliasing, which can cause inaccurate signal reconstruction. The Maximum recommended input frequency for each horizontal scale setting is shown in the display area. For best results, follow the guidelines shown in the table below:*

Horizontal Scale	Maximum Signal Frequency	Maximum Recommended Signal Frequency
20 us	50000 Hz	50000 Hz
50 us	50000 Hz	20000 Hz
100 us	50000 Hz	10000 Hz
200 us	25000 Hz	5000 Hz
500 us	10000 Hz	2000 Hz
1 ms	5000 Hz	1000 Hz
2 ms	2500 Hz	500 Hz
5 ms	1000 Hz	200 Hz
10 ms	500 Hz	100 Hz
20 ms	250 Hz	50 Hz
50 ms	100 Hz	20 Hz
100 ms	50 Hz	10 Hz
200 ms	25 Hz	5 Hz
500 ms	10 Hz	2 Hz
1 s	5 Hz	1 Hz

Marker Mode

This key provides display marker control with a horizontal soft key menu. Markers can be turned off or on with a choice of numeric readout for the signal measurements as follows:

Delta V – The numeric reading shows the difference in amplitude between marker positions.

Delta T – The numeric reading shows the difference in time between marker positions.

1/Delta T – The numeric reading shows the inverse of the time difference between markers, which can be used to determine the frequency of a repetitive waveform.

Absolute – The numeric reading shows the absolute amplitude at the marker position.

Toggle Marker

This key cycles through the available markers to select the active one (yellow) for positional adjustment on the display. The active marker is moved with the Left/Right (◀▶) keys.

Trigger Mode

This key provides submenu selections for the horizontal sweep trigger mode. The choices are as follows:

Auto – If a signal satisfying the Trigger Edge and Trigger Level settings is present, the display will sweep as in Normal Mode. If no signal satisfying the Trigger Edge and Trigger Level settings is present, then the display sweeps continuously until a signal satisfying the settings is acquired.

Normal – The display sweeps only when the input signal satisfies the Trigger Edge and Trigger Level settings.

Single – The display sweeps once after a key press is performed on the Single soft key.

Freeze – The display sweeps stop, allowing further analysis of the captured input signal.

Trigger Level

This key adjusts the signal threshold at which a horizontal sweep is initiated. The soft key activates a numeric entry box, and the Left/Right (◀▶) keys move the highlight over the desired number field. Numeric changes are entered directly with the keypad, in steps using the Up/Down (▲▼) keys, or with the spin knob.

Trigger Position

This key provides the submenu selections for the amount of pre-trigger waveform displayed on the screen. The choices are 10%, 50%, or 90% of the display allocated to the waveform preceding the trigger threshold.

Trigger Edge

This key provides the submenu for choosing which waveform edge triggers the modulation scope sweep. The selections are Rising, Falling, or Either.

Vertical Position

This key adjusts the vertical position of the waveform on the display using a horizontal submenu. Pressing the Move Up and Move Down soft keys shifts the waveform position by fixed increments.

Set DC Offset

Pressing this soft key zeros or compensates for any accumulated DC offset caused by drift in the input amplifier of the R8100 over long periods of time. This may show up as a DC level indicated on the Oscilloscope and DC Voltmeter when no input is connected to the Meter In port. With the Meter In port disconnected, press the soft key to eliminate the offset. The compensation is stored permanently in the R8100 until the next time this soft key is pressed.

2.2.4.4 Bar Graphs settings

The R8100 Bar Graph display provides a simultaneous analog and digital readout of critical signal characteristics. The analog display facilitates real time tuning adjustments of two-way radios while the digital reading provides precision in the measured result. Access the Bar Graphs using the Select Display soft key to bring up the horizontal submenu display choices. Three bar graphs are displayed for the received carrier while in Monitor Mode (see Figure 3.2.5.4-1):

Monitor Deviation

This graph displays the negative and positive peak frequency deviation of a modulated carrier (i.e. from the Frequency Error mean), available when Modulation Mode is FM.

Monitor AM%

This graph displays the negative and positive peak AM percentages of a modulated carrier, available when Modulation Mode is AM.

Frequency Error

This graph shows the frequency difference (error) of the input carrier minus the programmed frequency of the R8100 (i.e. Monitor Frequency).

Input Level

Input Lvl displays the RF input level of the carrier. Indicated units are Volts, Watts, or dBm as set with “Input Level Units” soft key in the RF Zone.

Note: *When the RF input power on the RF In/Out port is above +20 dBm (100 mW), the R8100 utilizes a broadband power detector for the measurement. The “Input Lvl” field in the RF Zone changes to “Watt Meter” to indicate this measurement mode.*

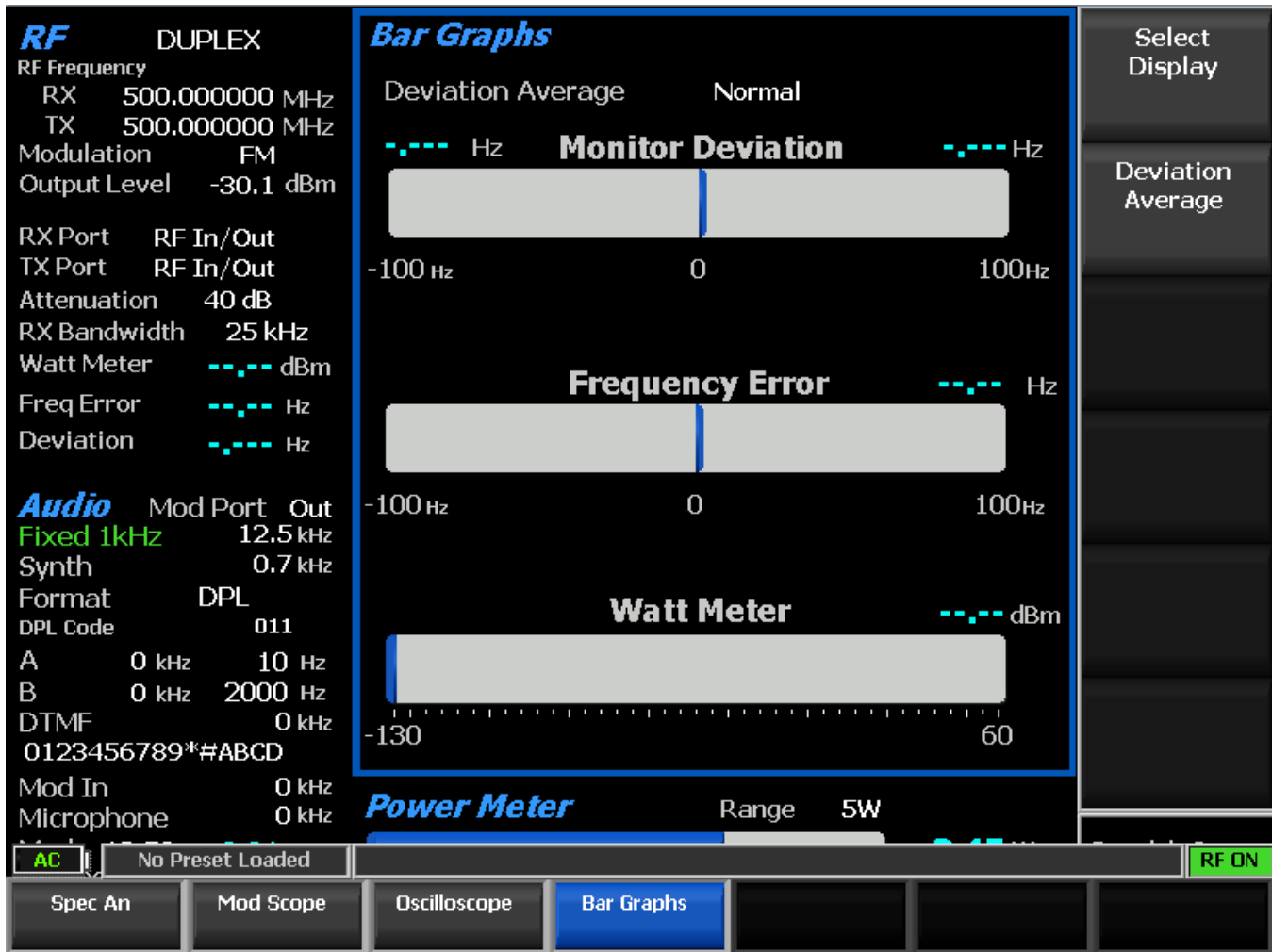

Figure 3.2.5.4-1 Bar Graphs screen in Display Zone

Deviation Average

The Bar Graph display can be adjusted to smooth the response using horizontal submenu selections activated with the Deviation Average soft key on the vertical menu. The Deviation Average settings are:

Normal – No smoothing is engaged, which provides the quickest measurement response.

Peak Average – The deviation peaks are averaged over a time window, which smooths the reading but slows the response.

Pwr-Weight Average – The deviation measurement is processed with an RMS converter, but the display calibration remains in peak units (i.e. a deviation of 3 kHz pk will read 3 kHz on the numeric readout and bar graph). This type of processing significantly reduces the effect of narrow deviation spikes and noise while providing a speed of response similar to the normal mode. **Note:** *Scale calibration and the peak readings are only valid for single tone repetitive sine wave modulation. For the RMS value of any modulation waveform, divide the displayed peak reading by 1.414.*

RMS Average – The deviation measurement is the square root of the mean of the squares of the deviation values. This type of processing significantly reduces the effect of narrow deviation spikes and noise while

providing a speed of response similar to the normal mode. **Note:** Scale calibration and the RMS readings are valid for any wave modulation (e.g. sawtooth).

2.2.4.5 General Sequence settings (appears when General Sequence is selected in Meter Zone)

Decode to Standard

Choose which SelCall (Selective Calling) tone standard is used to display the code symbols associated with the frequency and duration of decoded sequential audio tone bursts. Select using the Up/Down (▲▼) keys or rotating the spin knob; then press Enter. If “None” is selected, the decoder assigns sequential codes 1 through 20 for each successive tone. Otherwise, the codes are matched to the frequencies decoded per the following standards: CCIR1, CCIR2, PCCIR, CCITT, EEA, EIA, Euro, NATEL, MODAT, ZVEI1, ZVEI2, ZVEI3, PZVEI, DVZEI, and PDZVEI (see Figure 3.2.5.5-1). **Note:** For correct operation, input tones should have a duration of 0.5 seconds or less.

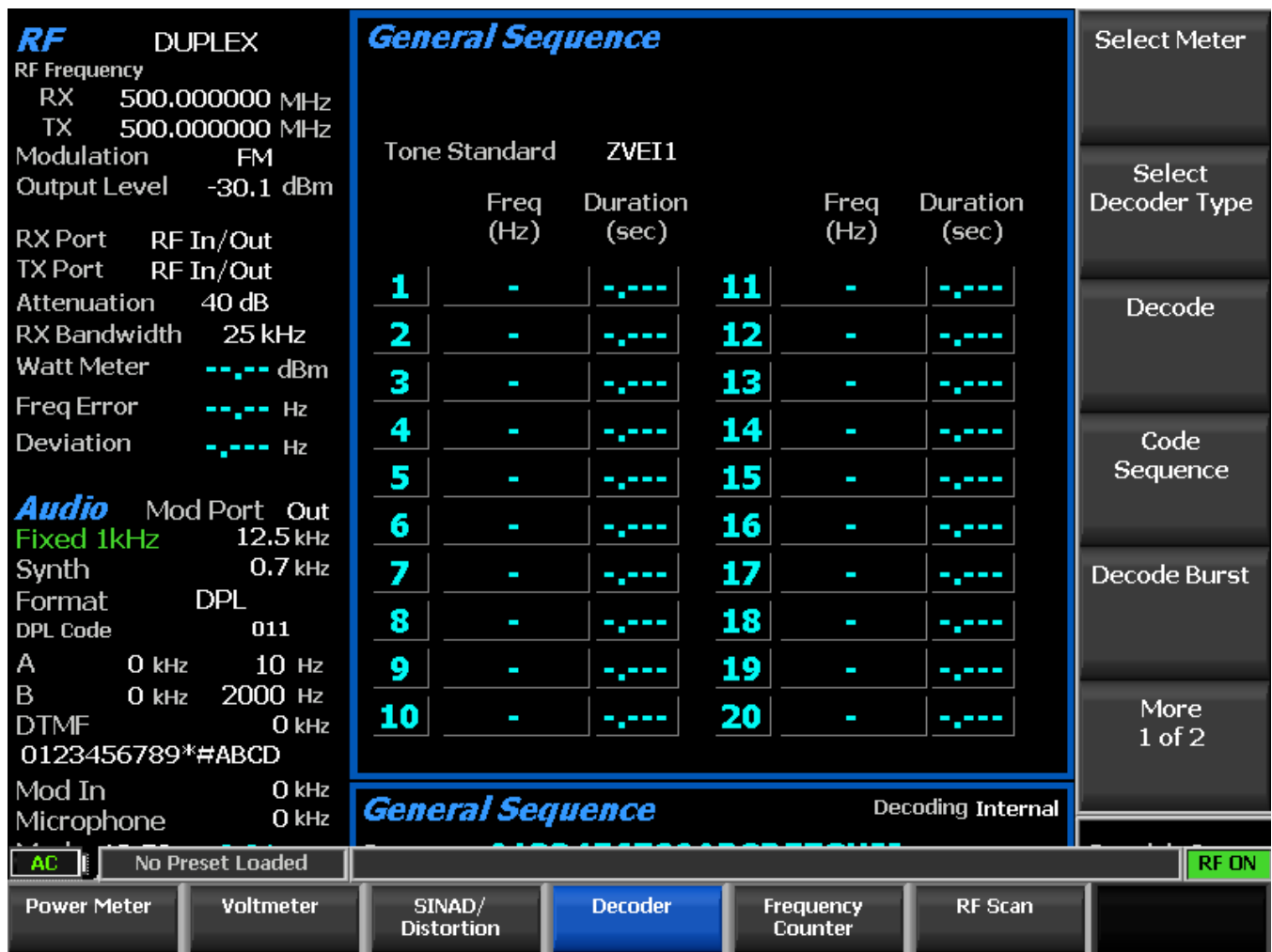

Figure 3.2.5.5-1 General Seq screen in Display Zone

2.2.5 Meter Zone

The R8100 has several metering functions consisting of general purpose and specialized instruments providing detailed analysis of the recovered baseband content from RF signals. They are accessed from

the main menu with the Meter Zone soft key and displayed in a dedicated area on the main screen below the Display Zone. (See Figure 3.2.6-1, which shows the RF Scan meter.)

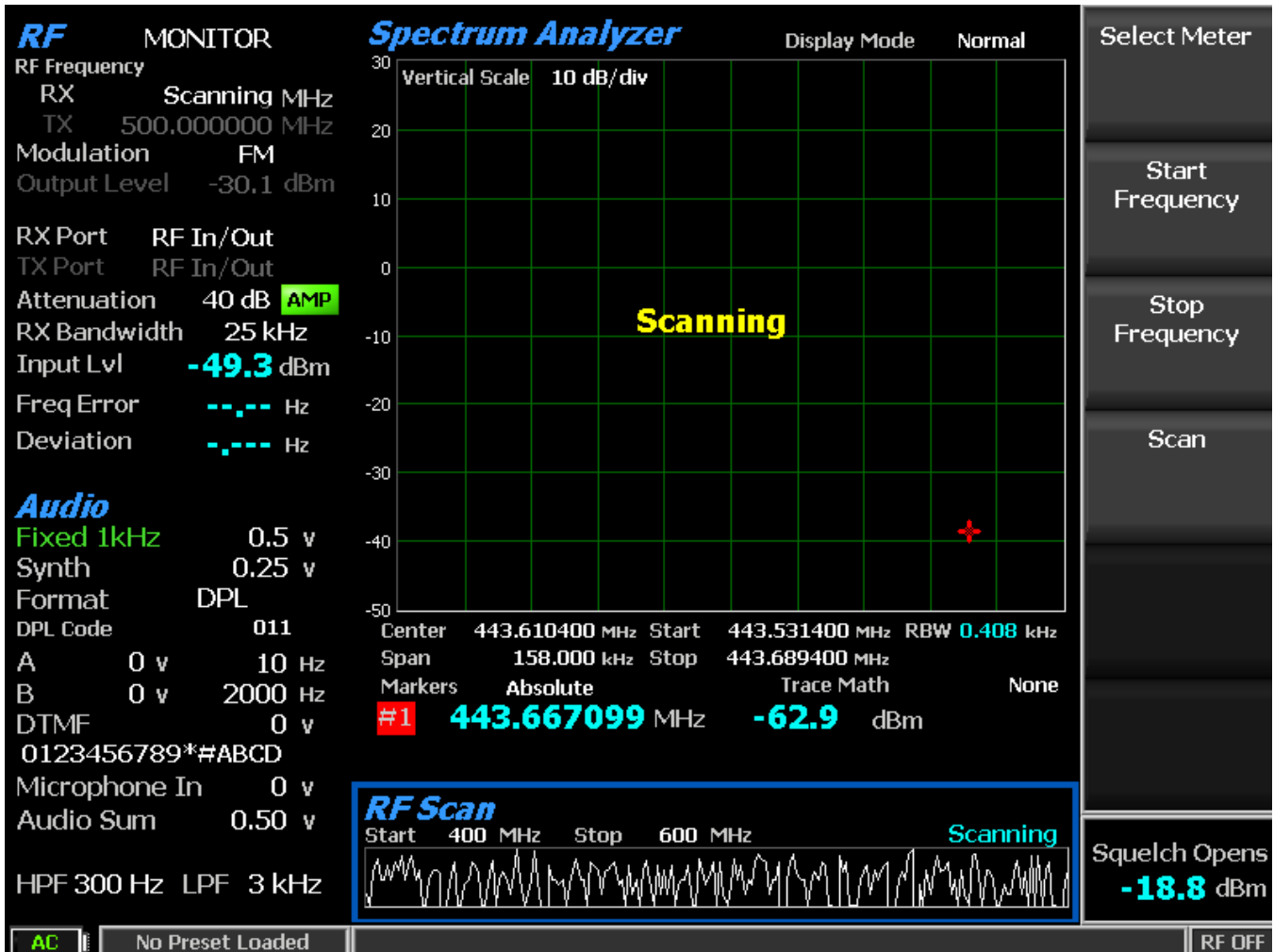

Figure 3.2.6-1 Meter Zone submenu showing RF Scan meter

Pressing the Select Meter soft key displays the available metering functions on a horizontal submenu (see Figure 3.2.6-2). They include Power Meter, Voltmeter, SINAD/Distortion, Decoder, Frequency Counter, and RF Scan.

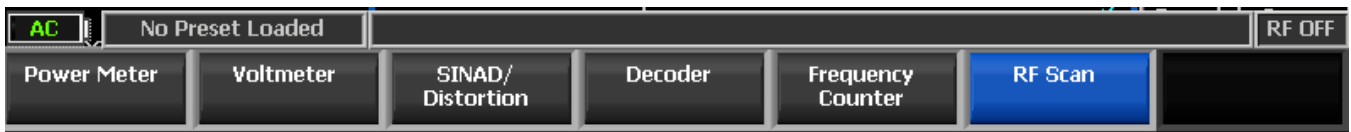

Figure 3.2.6-2 Meter Zone submenu after Select Meter soft key press

2.2.5.1 Power Meter

The Power Meter provides a bar graph display and numeric readout in Watts of the broadband input power applied to the RF In/Out port (Figure 2.2.5.1-1). **Note:** For best accuracy, disable the Pre-amplifier in Monitor Mode, and set the Gen Port in Generate Mode to RF In/Out.

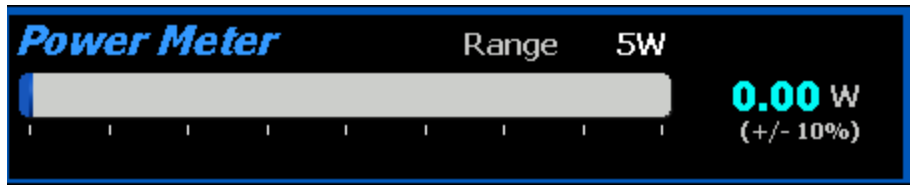

Figure 2.2.5.1-1 RF Power Meter screen

2.2.5.2 Voltmeter

This selection provides an AC and DC voltmeter mode for measuring the amplitude of electrical voltages at the Meter In port with the following menu selections:

Select Voltmeter Mode

Choose AC Volts or DC Volts on a horizontal menu.

AC Volts measures AC voltage applied to the Meter In port. The dBm computation assumes an impedance of 600 Ohms. The full scale AC Range is selectable via a horizontal submenu.

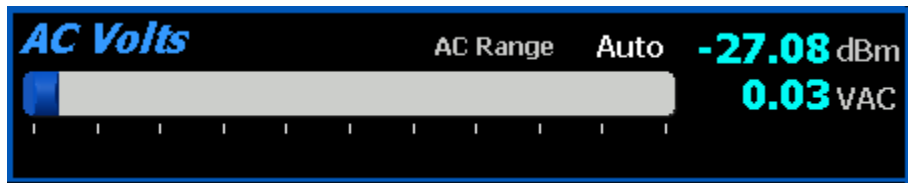

Figure 2.2.5.2-1 AC Volts display

DC Volts measures DC voltage applied to the Meter In port. The full scale DC Range is selectable via a horizontal submenu. **Note:** *If a DC offset is apparent with no input connected, it can be zeroed out by using the Set DC Offset function.*

Note: *Pressing Display Zone, Oscilloscope, Set DC Offset soft key zeros or compensates for any accumulated DC offset caused by drift in the input amplifier of the R8100 over long periods of time. This may show up as a DC level indicated on the Oscilloscope and DC Voltmeter when no input is connected to the Meter In port. With the Meter In port disconnected, press the soft key to eliminate the offset. The compensation is stored permanently in the R8100 until the next time this soft key is pressed.*

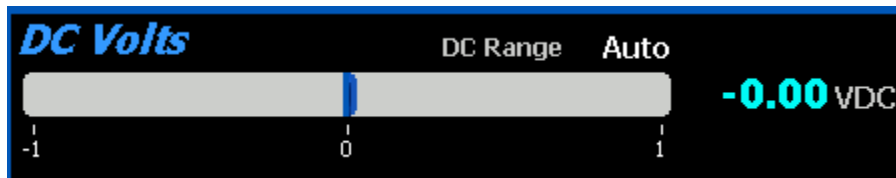

Figure 2.2.5.2-2 DC Volts display

AC Range

This selection is available when Select Voltmeter Mode is AC Volts. Choices include Auto (auto-ranging), 1 Volt, 10 Volts, and 70 Volts RMS. **Note:** *The range on AC and DC must be 1 or 10 Volts to use 600 Ohm Input Impedance (see 2.2.8.2 System Settings).*

Set dBr Reference

This selection is available when Select Voltmeter Mode is AC Volts and a reference input voltage is not set. When selected, dBm measurements are frozen, and a dBr indicator appears. The dBr indicates the normalized measurement between the reference input voltage and the current input voltage.

Clear dBr Reference

Available when Select Voltmeter Mode is AC Volts and a reference input voltage is set. When selected, dBm measurements are resumed, and the dBr indicator disappears.

DC Range

The DC Range is available when Select Voltmeter Mode is DC Volts. Choices include Auto (auto-ranging), 1 Volt, 10 Volts, 100 Volts, and the Battery voltage when that upcoming option is installed.

Note: *The range on AC and DC must be 1 or 10 Volts to use 600 Ohm Input Impedance (see 2.2.8.2 System Settings).*

2.2.5.3 SINAD/Distortion

This selection provides Signal in Noise and Distortion (SINAD) and audio distortion measurements for a radio under test (see Figure 2.2.5.3-1).

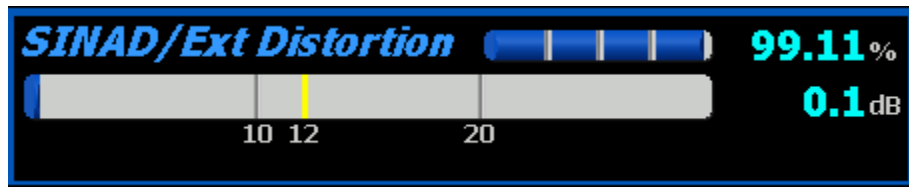

Figure 2.2.5.3-1 SINAD display

Select Audio Measurement

Choose SINAD/Ext Distortion or Internal Distortion on a horizontal menu.

SINAD/Ext Distortion key provides a SINAD and External Distortion measurement of the recovered audio signal applied to the Meter In port from an external radio (Figure 2.2.5.3-1). The test is performed using a 1 kHz modulated RF carrier applied to the radio's antenna port by the R8100. The RF level is adjusted in the RF Zone while monitoring the SINAD meter to determine the receiver sensitivity per EIA (12 dB yellow tick mark) and other standards (See SINAD Measurement).

Internal Distortion key measures the distortion in percent of the internally-recovered audio from a transmitter modulated with a 1 kHz sine wave when the R8100 is in Monitor Mode (Figure 2.2.5.3-2).



Figure 2.2.5.3-2 Internal Distortion display

2.2.5.4 Decoder

This is the entry point for the suite of tone decoding functions on the R8100.

Select Decoder Type

Choose from the available decoding functions on a horizontal menu. These include PL/Period Counter, DPL Decode, DTMF Decode, 2-Tone Decode, 5/6 Decode, and General Sequence.

PL/Period Counter selection displays the frequency and numeric code of the recovered audio from a radio modulated with the Motorola Private-Line (PL) format (Figure 2.2.5.4-1). The period counter allows rapid high resolution measurements of non-PL low frequency modulation without the long gate times associated with frequency counting. A vertical submenu provides adjustment of the Low and High Pass filters to reduce noise for more accurate measurements. Recommended filter settings for PL: HP= 1 Hz; LP = 300 Hz.

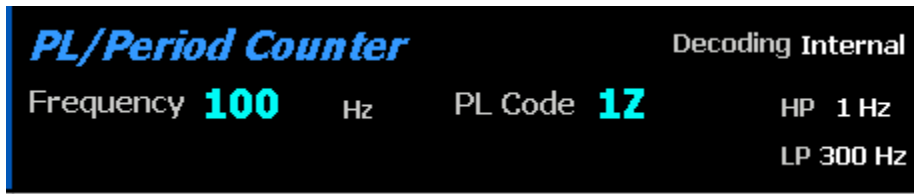

Figure 2.2.5.4-1 PL/Period Counter screen

DPL Decode selection provides a numeric code readout from the recovered audio of a radio modulated with the Motorola Digital Private-Line (DPL) format (Figure 2.2.5.4-2). A vertical submenu provides adjustment of the Low and High Pass filters to reduce noise for more accurate measurements. Recommended filter settings for DPL: HP= 1 Hz; LP = 3 kHz.

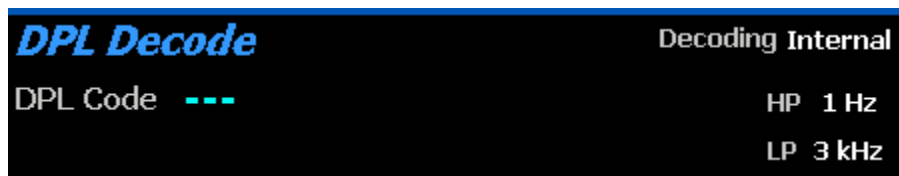

Figure 2.2.5.4-2 DPL Decode screen

DTMF Decode Decodes DTMF (Dual Tone Multi Frequency) signals used in testing telephone interfaced systems (Figure 2.2.5.4-3). A vertical submenu provides adjustment of the Low and High Pass filters to reduce noise for more accurate measurements. Recommended filter settings for DTMF: HP= 1 Hz; LP = 3 kHz. **Note:** *The R8100 displays the history of previously decoded DTMF codes, with the right-most code digit being replaced by the most recently decoded tone. The DTMF Code field appears static when the transmitted code is not changing or nothing is being decoded. Press the Reset soft key to clear the history.*

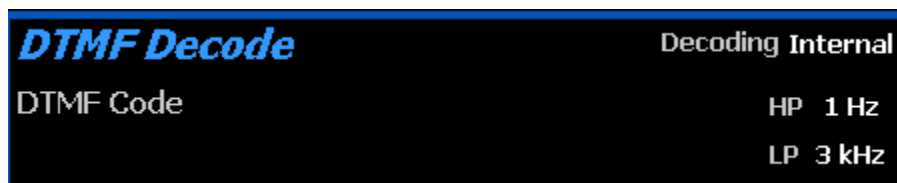

Figure 2.2.5.4-3 DTMF Decode screen

2-Tone Decode selection decodes the two-tone sequential paging format. The meter displays the Tone A/Tone B (Tone 1 and Tone 2) frequencies and durations (Figure 2.2.5.4-4). A vertical submenu provides adjustment of the Low and High Pass filters to reduce noise for more accurate measurements. The Decode soft key is used to start or stop decoding. Recommended filter settings for 2-Tone Decode: HP= 1 Hz; LP = 3 kHz.

2-Tone Decode			Decoding Internal
Tone 1	Hz	sec	HP 1 Hz
Tone 2	Hz	sec	LP 3 kHz

Figure 2.2.5.4-4 2-Tone Decode screen

5/6 Tone Decode selection decodes the 5/6 tone sequential paging format (Figure 2.2.5.4-5). The meter displays a table with the decoded cap code along with the individual tone frequencies and durations. A vertical submenu allows selection of the meter sensitivity from MIN to MAX via the spin knob, Up/Down (▲ ▼) keys, or repeated presses of the Sensitivity soft key. A vertical submenu provides adjustment of the Low and High Pass filters to reduce noise for more accurate measurements. Recommended filter settings for 5/6 Tone: HP= 1 Hz; LP = 3 kHz.

5/6 Tone Decode							Decoding Internal
Cap Code	-	-	-	-	-	-	HP 1 Hz
Freq (Hz)	0	0	0	0	0	0	LP 3 kHz
Dur(sec)	0.000	0.000	0.000	0.000	0.000	0.000	

Figure 2.2.5.4-5 5/6-Tone Decode screen

General Sequence selection decodes the individual frequency and time duration for up to 20 tones in a tone sequence. This function overwrites the entire Display Zone section of the main screen and provides a detailed display of data (Figure 2.2.5.4-6). A vertical submenu provides adjustment of the Low and High Pass filters to reduce noise for more accurate measurements, an Input Decoding selection key to select internal or external decoding, a Decode key with start and stop settings to control the decode function, and a selection window to choose the SelCall standard (or none) used for decoding.

When a standard is selected, the decoded tones are mapped to the selected standard, and the Tone Code is listed with each tone in the table. When no standard is selected, the decoded tones are listed in numerical order. The recommended filter settings on the R8100 are: HP= 1 Hz; LP = 3 kHz. **Note:** For correct operation, input tones should have a duration of 0.5 seconds or less.

General Sequence					
Tone Standard			ZVEI1		
	Freq (Hz)	Duration (sec)		Freq (Hz)	Duration (sec)
1	-	-.---	11	-	-.---
2	-	-.---	12	-	-.---
3	-	-.---	13	-	-.---
4	-	-.---	14	-	-.---
5	-	-.---	15	-	-.---
6	-	-.---	16	-	-.---
7	-	-.---	17	-	-.---
8	-	-.---	18	-	-.---
9	-	-.---	19	-	-.---
10	-	-.---	20	-	-.---

General Sequence		Decoding Internal
Sequence	0123456789ABCDEFGHIJ	HP 1 Hz
		LP 3 kHz

Figure 2.2.5.4-6 General Sequence Decode screen

High Pass Filter

This setting activates a horizontal submenu with audio filter selections that determine the high pass frequency for the R8100’s baseband response to recovered audio. The “cut-on” frequency selections are 5 Hz, 300 Hz, and 3 kHz. This setting is used in conjunction with the Low Pass Filter to determine the audio pass band for the R8100 baseband circuitry.

Low Pass Filter

This setting activates a horizontal submenu with audio filter selections that determine the low pass frequency for the R8100’s baseband response to recovered audio. The “cut-off” frequency selections are 300 Hz, 3 kHz, and 20 kHz. This setting is used in conjunction with the High Pass Filter to determine the audio pass band for the R8100 baseband circuitry.

Input Decoding

Input Decoding selects the signal source used for the R8100 frequency counter and decode functions. When set to Internal, the recovered audio or tones from a demodulated received signal are used as the signal source. The External setting directs an externally applied signal at the Meter In port to the R8100 frequency counter and decode circuits.

2.2.5.5 Frequency Counter

In Monitor Mode, this soft key enables a general-purpose frequency counter for the recovered baseband audio or IF frequency displayed in the modulation scope (Figure 2.2.5.5-1 Frequency Counter screen). In Generator Mode, the counter measures the frequency of the internal or external modulation applied to the RF carrier. In External Scope Mode, the counter measures the frequency of signals applied to the Meter In port.

Resolution

This solution activates a horizontal submenu with selections for the counter resolution. The settings include 0.1 Hz, 1.0 Hz, and 10 Hz resolution.

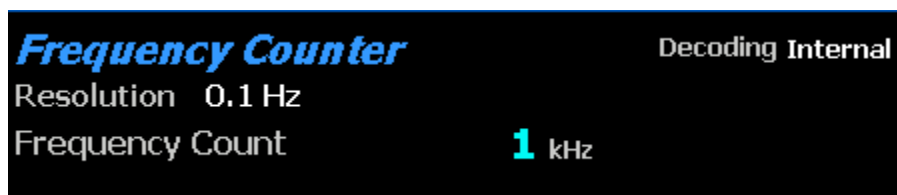

Figure 2.2.5.5-1 Frequency Counter screen

2.2.5.6 RF Scan

This selection searches for the strongest RF signal that is above the “Squelch Opens @” setting on the active RF input port. The R8100 locks onto and automatically centers its operating frequency on this carrier (Figure 2.2.5.6-1). The search frequency range in MHz is entered using Start Frequency and Stop Frequency soft keys. Scanning begins once the Scan, Start soft keys are selected. Scanning can be manually stopped by selecting the Scan, Stop soft keys. The meter graph displays an automatically-scaled spectrum of the entire scan range. Once a signal is acquired, the RF Scan meter stays locked on that frequency even if the carrier disappears. It resumes scanning once the Scan, Start soft keys are selected. The RF Scan meter operates only when it is highlighted; otherwise, it becomes inactive.

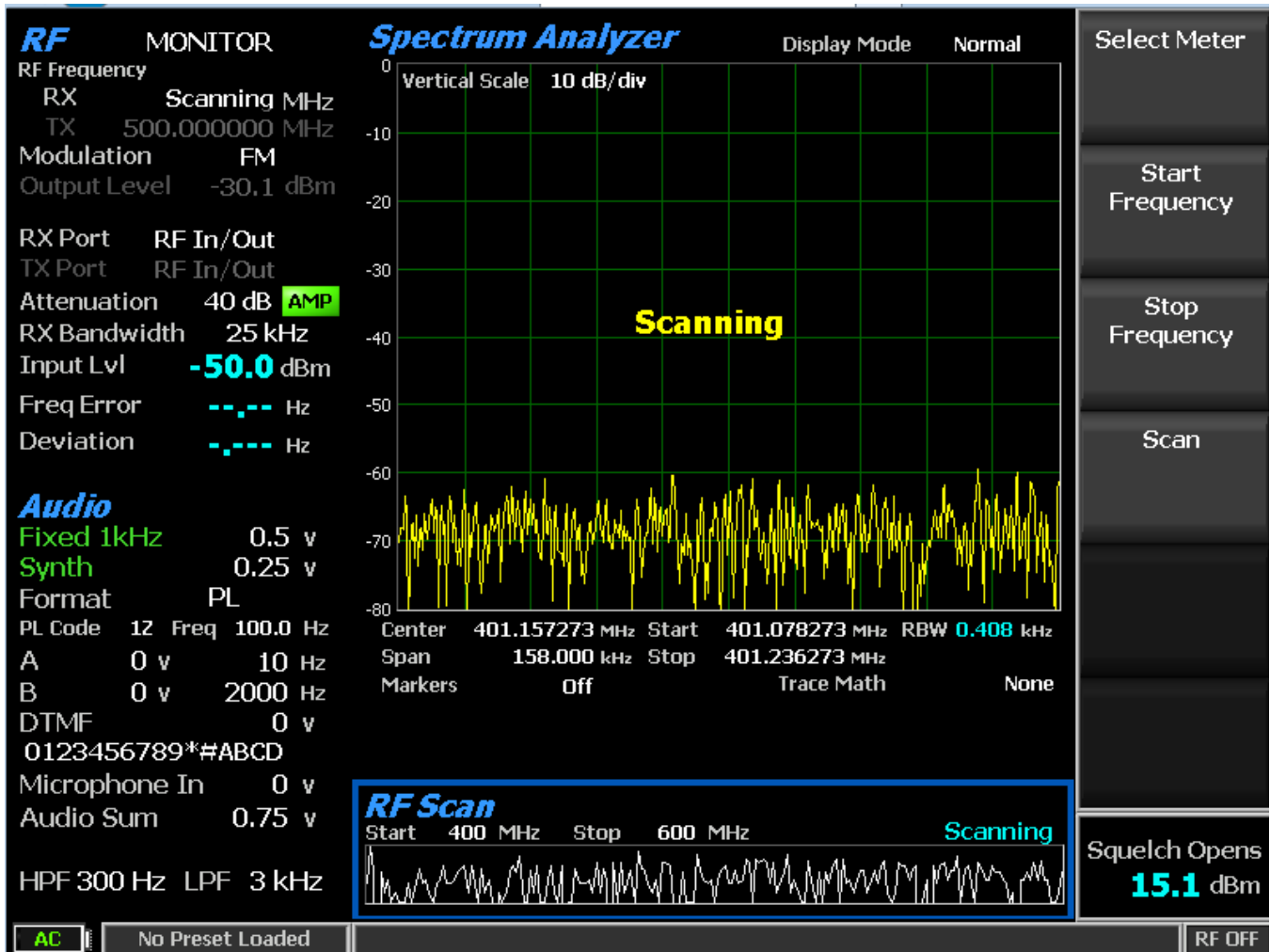

Figure 2.2.5.6-1 RF Scan display

2.2.6 Instrument Menu

The Instrument menu provides several of the measurement functions on the R8100 in a dedicated full screen display. This makes it easier to view smaller waveform details and provide more numeric fields with instrument-specific data. Figure 3.2.7-1 shows the submenu after pressing the Instrument navigation button. The vertical soft key submenu lists the instruments available in a full screen display. While the Spectrum Analyzer, Modulation Scope, and Oscilloscope displays are available elsewhere on the R8100, the size is limited in those areas since they are shared with other measuring functions. The optional Dual Display, Tracking Generator, and Cable Fault Locator functions are full screen instruments and only available from the Instrument menu. For convenience, the other meters on the R8100 such as RF Scan, AC Volts, etc., can also be directly accessed in Instrument menu.

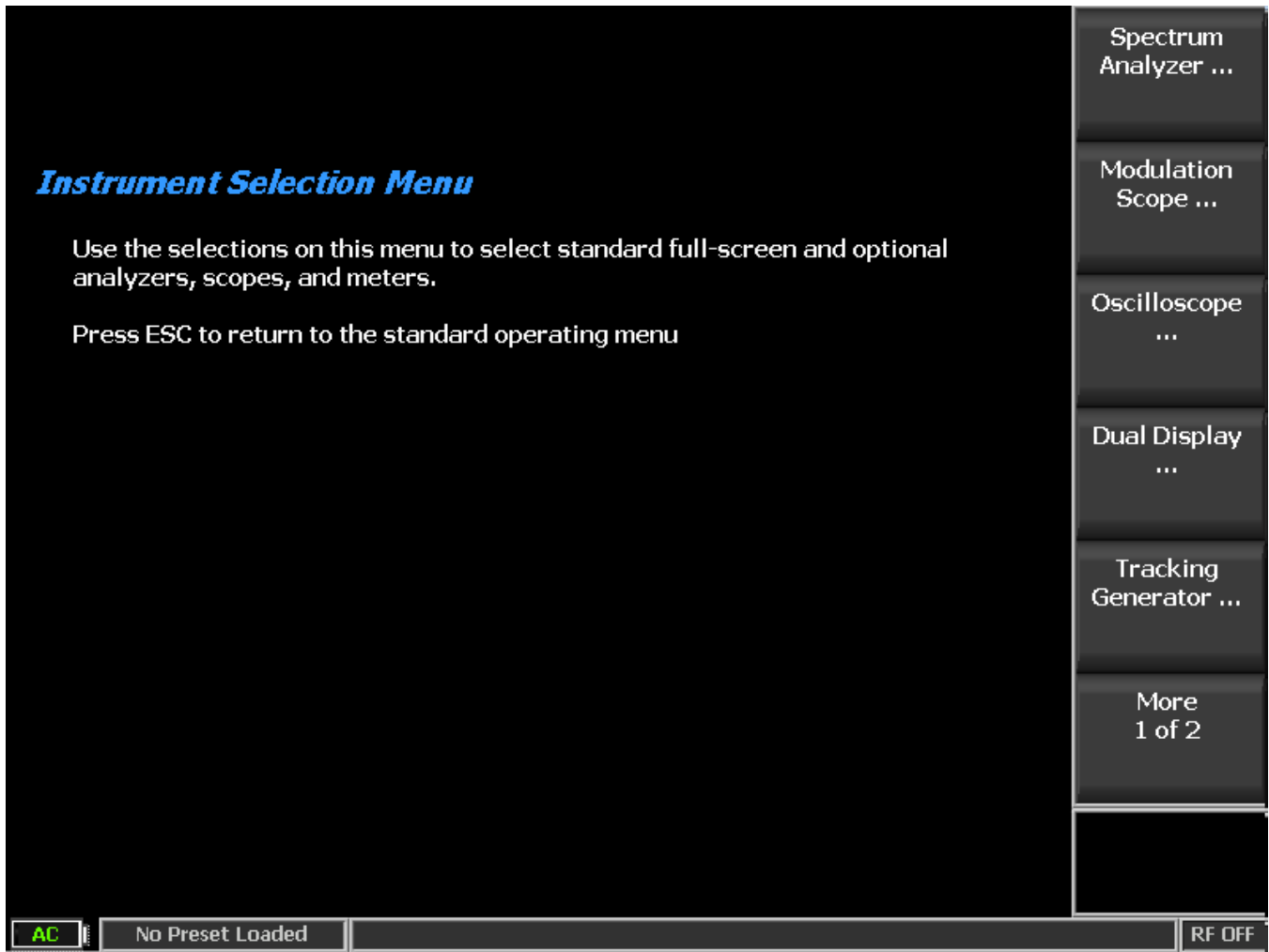

Figure 3.2.7-1 Submenu after pressing Instrument Navigation key

The sub-menus, control, and settings for the full screen instruments duplicate those of the limited screen versions in the Display Zone. When applicable, additional soft keys appear to exploit the extra display area.

2.2.6.1 Full-screen Spectrum Analyzer Mode

With the Enhanced Spectrum Analyzer option, four markers and associated data can be displayed in the Spectrum Analyzer Instrument Mode as shown in Figure 2.2.6.1-1. A “Select Marker” soft key allows selection of each marker for movement across the screen. **Note:** For an R8100 without the Enhanced Spectrum Analyzer option, the Toggle Marker soft key activates the two available markers.

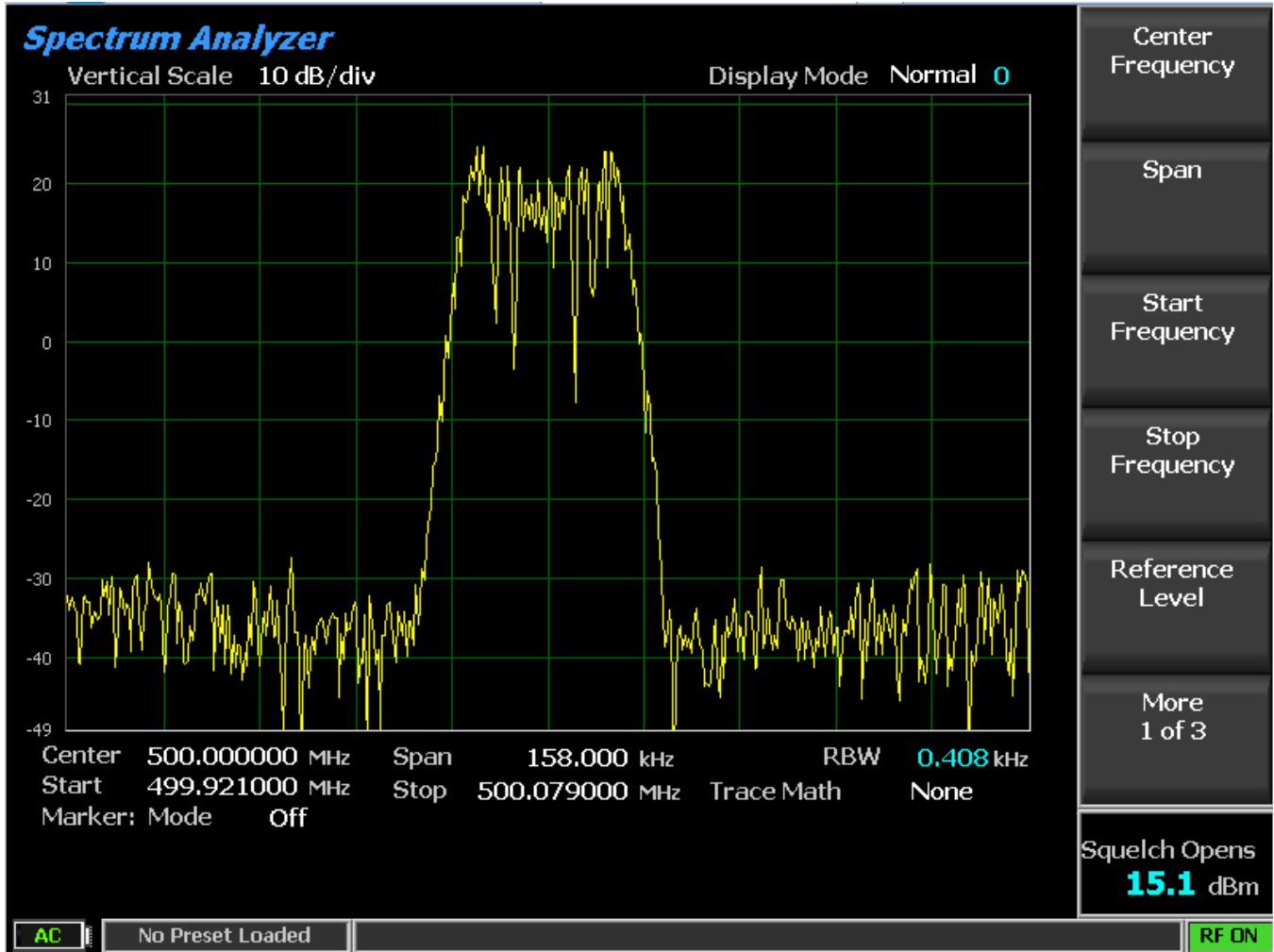

Figure 2.2.6.1-1 Submenu in Spectrum Analyzer Instrument Mode

2.2.6.2 Dual Display mode

The optional Dual Display Mode provides a convenient one screen presentation of two instruments often used together, the Spectrum Analyzer and Modulation Scope. This gives a user control and a simultaneous view of the results from both measurement functions. Figure 2.2.6.2-1 shows the R8100 screen after pressing the Dual Display soft key.

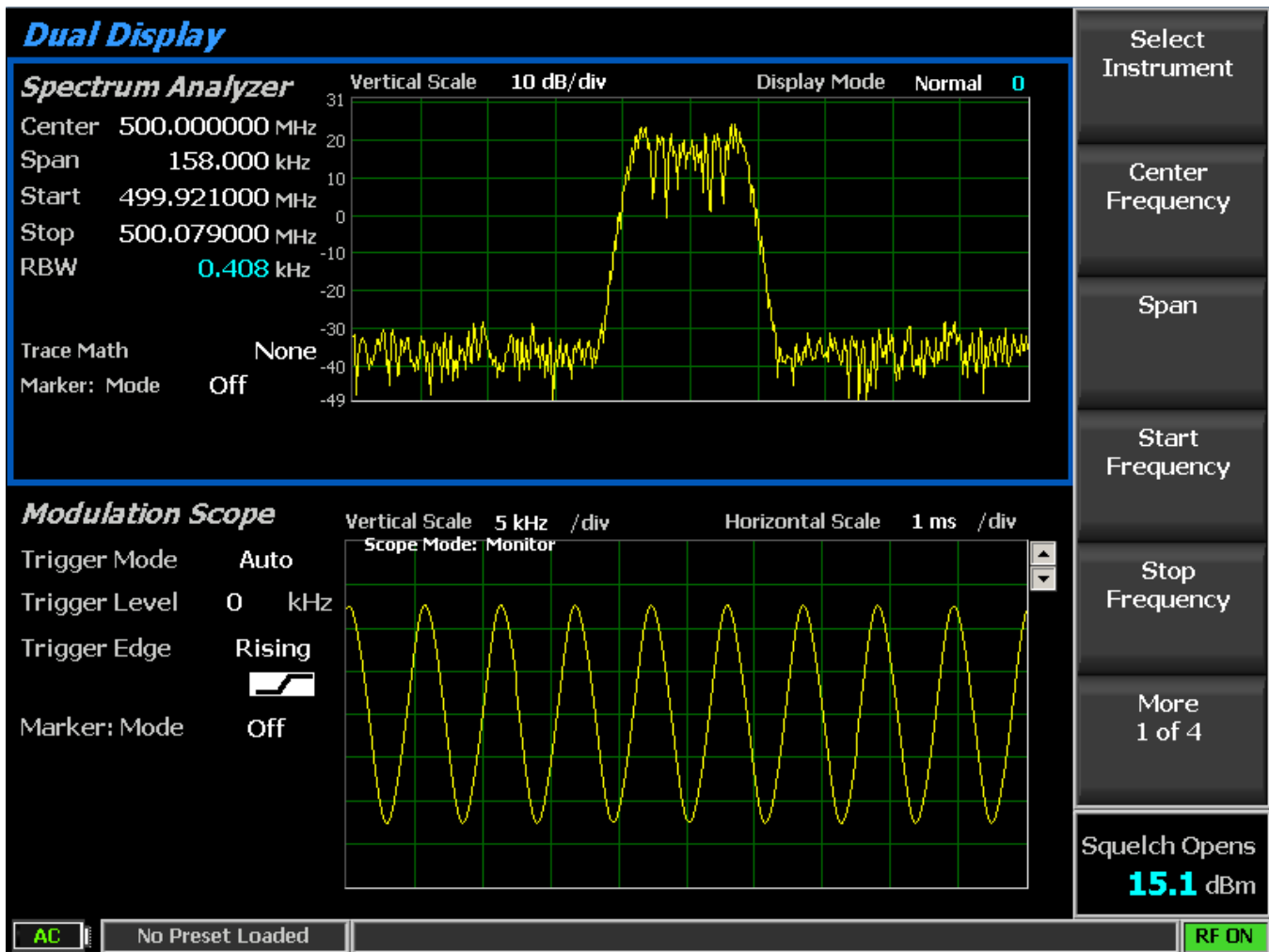

Figure 2.2.6.2-1 Dual Display Mode

In Dual Display Mode the submenus, control, and parameter entry are unchanged from the full screen versions of the Spectrum Analyzer and Modulation Scope.

Gen Port

This setting selects the active port (RF In/Out or Gen Out) for the swept R8100 tracking generator output in a selection table using the Up/Down (▲▼) keys or spin knob.

Note: If RF Level Offset is enabled, the Gen Port label is cyan-colored, indicating that Output Level amplitudes are adjusted by the Gen Port-specific offset. See Section 2.2.8.2 for details.

Monitor Port

This setting selects the port monitored by the Spectrum Analyzer as either the ANTENNA or the RF In/Out front panel connector. Choose in a list entry window using the Up/Down (▲▼) keys or spin knob.

Note: If RF Level Offset is enabled, the Mon Port label is cyan-colored, indicating that RX measurements are adjusted by the Mon Port-specific offset. See Section 2.2.8.2 for details.

2.2.6.3 Tracking Generator Mode

The optional Tracking Generator function sets up the R8100 RF generator in a sweeping mode for simultaneous use with the Spectrum Analyzer display. This delivers a valuable capability for measuring and servicing a wide variety of RF filtering and combining networks. Pressing the Tracking Generator key provides the full screen display shown in Figure 2.2.6.3-1. **Note:** Enabling the Tracking Generator suspends the Standard zone operation of the R8100 (e.g. RF Zone, Audio Zone, etc.). To restore Standard zone operation, press the appropriate mode key such as Monitor, Generate, Duplex, etc.

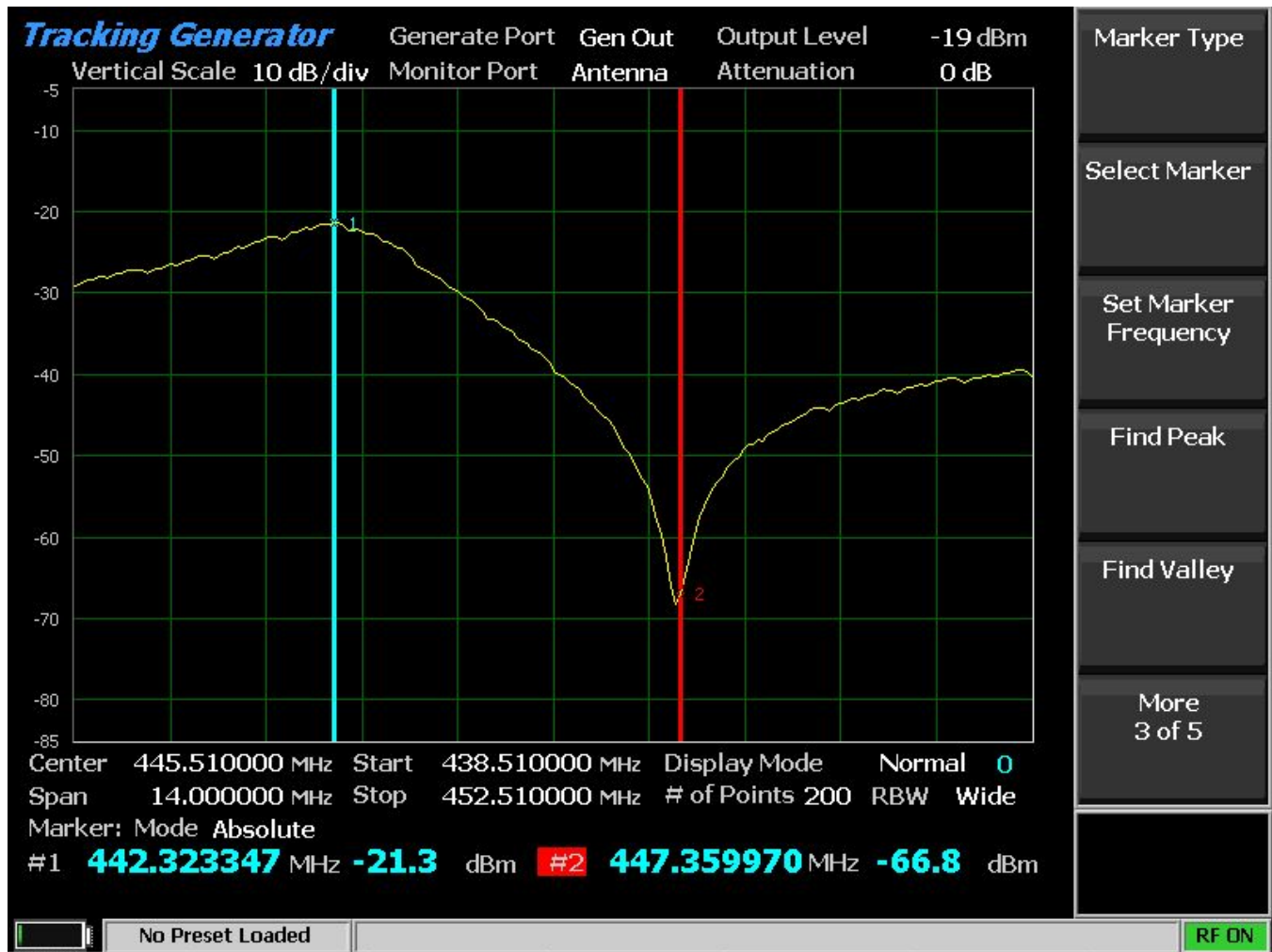

Figure 2.2.6.3-1 Tracking Generator Mode

The Tracking Generator settings are similar to those used when operating the RF Generator and Spectrum Analyzer independently. An exception is the frequency setting, which is common to both, since the Spectrum Analyzer is lock stepped to and tracks the swept RF Generator.

Center Frequency

This key sets the Tracking Generator center frequency from 250 kHz to 3 GHz in a data entry window using the arrow keys, keypad, or tuning knob. Pressing Enter completes the change, and Esc cancels the entry.

Span

This key sets the total frequency window for tracking generator operation in MHz. The Span entry total is automatically split on each side of the current center frequency.

Start Frequency

This key sets the Tracking Generator Start Frequency in MHz. Use with the Stop Frequency to establish a desired frequency range for Tracking Generator operation. The R8100 automatically centers the frequency display midway between Start and Stop frequencies.

Stop Frequency

This key sets the Tracking Generator Stop Frequency in MHz. Use with the Start Frequency to establish a desired frequency range for Tracking Generator operation. The R8100 automatically centers the frequency display midway between Start and Stop frequencies.

Vertical Scale

This key selects the Vertical Scale resolution for the display's major grid lines from 1 dB/div to 10 dB/div via a horizontal soft key menu.

Reference Level

This key adjusts the maximum level (top line) for the vertical scale of the Spectrum Analyzer in Tracking Generator Mode from -120 dBm to + 60 dBm in 1 dB increments.

of Points

This key adjusts the number of data points acquired and displayed. Higher settings increase the trace resolution for viewing signal detail but also slow the update rate.

Display Mode

This mode selects the display presentation with the following horizontal menu choices:

Normal – The display updates continuously.

Freeze – The display provides a snapshot of the current display indication and stops additional updates.

Note: *In Freeze Mode, the R8100 reacquires data and updates the display whenever “Center Marker” or “Center Peak” is pressed.*

Max Hold – The display retains the highest peak signal amplitudes measured during successive sweeps.

Average – The displayed signal amplitudes are a rolling average of the peak amplitudes measured on each successive sweep. The average consists of one to five sweeps, shown beside the mode indication.

Marker Mode

This key provides display marker control via a horizontal soft key menu. Markers can be turned off or on with a choice of numeric readout for the signal measurements.

Absolute – This selection displays the frequency and absolute signal amplitude for each marker selected (total of 4).

Delta – This selection displays the frequency and amplitude difference between each pair of markers selected (1-2 & 3-4).

Marker Type

This key sets the display marker type in a horizontal menu with selections including point cross, vertical bar, horizontal bar, and full cross.

Select Marker

This key selects one of four available markers on a horizontal submenu for position adjustment on the display.

Set Marker Frequency

This key directly sets the frequency of the selected marker in MHz via a data entry window.

Center Marker

This key centers the operating frequency and display of the R8100 Spectrum Analyzer around the frequency of the active marker.

Find Peak

This key moves the cursor to the highest signal reading in the display window and provides a numeric readout of the amplitude and frequency.

Find Valley

This key moves the cursor to the lowest signal reading in the display window and provides a numeric readout of the amplitude and frequency.

3 dB Marker

Frequency selection places a marker above and below center frequency where the signal is -3 dB below the peak amplitude measured at center frequency. The upper and lower frequencies are shown on the display.

Delta selection places a marker above and below center frequency where the signal is -3 dB below the peak amplitude measured at center frequency. The difference between these two frequencies is shown on the display.

Output Level

The Output Level adjusts the RF level of the Tracking Generator output at the active output port from -95 dBm to 5 dBm on the RF Gen Out port and -130 dBm to -30 dBm on the RF In/Out port.

Attenuation

This setting adjusts the Monitor Port RF input signal attenuation in 2 dB steps from 0 to 62 dB. Select in a list entry window using the Up/Down (▲ ▼) keys or spin knob.

Pre-Amplifier

This setting enables a supplementary input amplifier that extends the sensitivity of the RF Monitor by improving the S/N ratio for low signal levels. **Note:** *To avoid input overload and erroneous signal strength readings, use the pre-amplifier only under the following conditions:*

Input Port	Maximum input level for using pre-amplifier
Antenna	(Input signal in dBm – Attenuator setting) is equal or less than -40 dBm
RF In/Out	(Input signal in dBm – Attenuator setting) is equal or less than -10 dBm

Gen Port

This setting selects the active port (RF In/Out or Gen Out) for the swept R8100 Tracking Generator output in a selection table using the Up/Down (▲ ▼) keys or spin knob.

Note: *If RF Level Offset is enabled, the Gen Port label is cyan-colored, indicating that Output Level amplitudes are adjusted by the Gen Port-specific offset. See Section 2.2.8.2 for details.*

Monitor Port

This setting selects the port monitored by the Spectrum Analyzer as either the ANTENNA or the RF In/Out front panel connector. Choose in a list entry window using the Up/Down (▲ ▼) keys or spin knob.

Note: *If RF Level Offset is enabled, the Mon Port label is cyan-colored, indicating that RX measurements are adjusted by the Mon Port-specific offset. See Section 2.2.8.2 for details.*

Normalize

This key creates a baseline for measuring system under test response by zeroing out the Spectrum Analyzer trace. When enabled, a visual indicator appears, and the trace color changes similar to Figure 2.2.6.3-2. To reset the baseline after changing any Tracking Generator parameters, select Off and then On again.

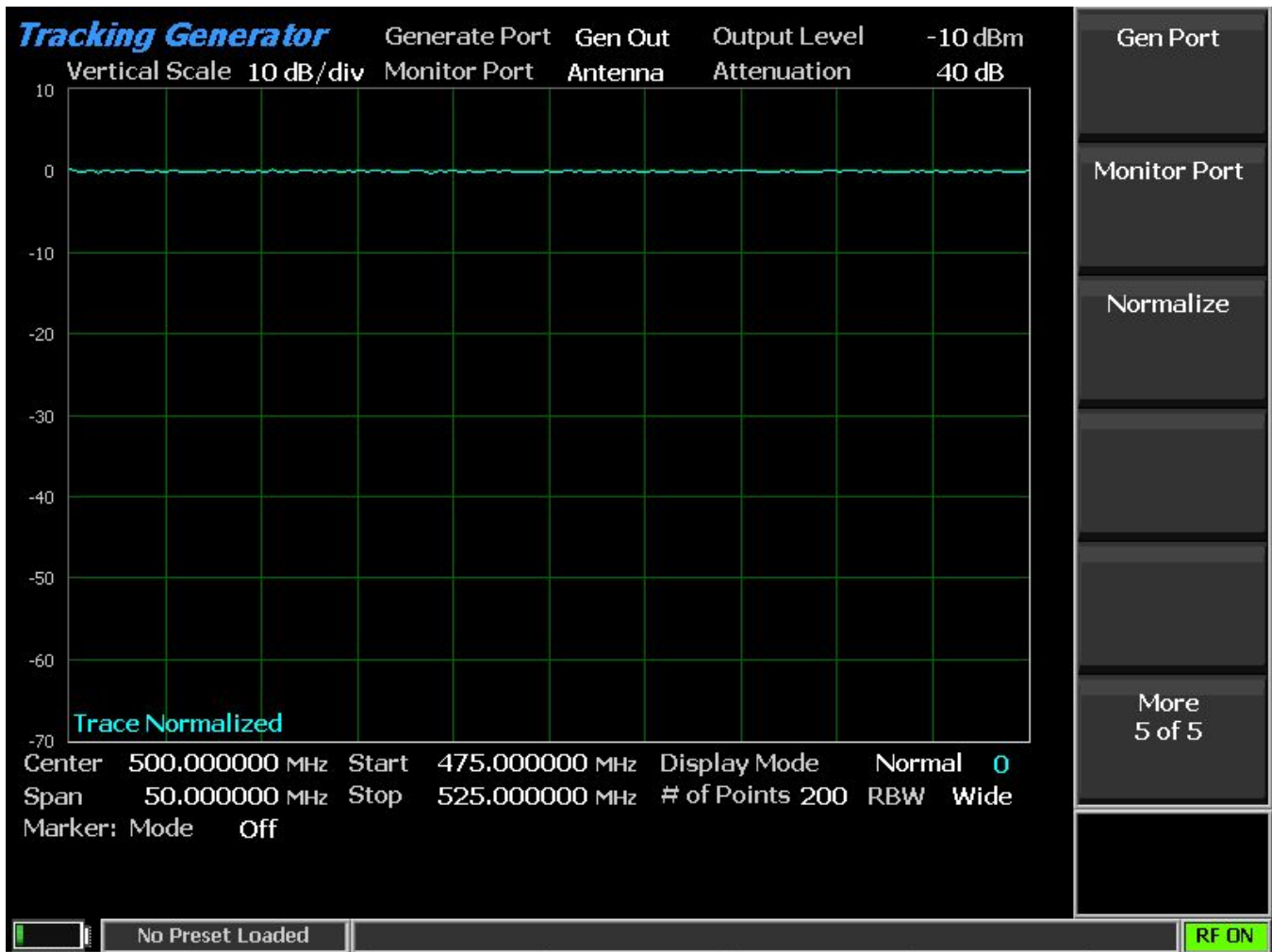

Figure 2.2.6.3-2 Normalized Spectrum Analyzer trace

2.2.6.4 Cable Fault Locator Mode

The optional Cable Fault Locator Mode uses the R8100 Tracking Generator along with FFT analysis to determine distance to a fault or termination mismatch in RF cables. Pressing the Cable Fault Locator soft key provides the full screen display shown in Figure 2.2.6.4-1. The Cable Fault Locator is used with an optional directional coupler or splitter. **Note:** *Enabling the Cable Fault Locator Mode suspends the Standard Zone operation of the R8100 (e.g. RF Zone, Audio Zone, etc.). To restore Standard Zone operation, press an associated mode key such as Monitor, Generate, Duplex, etc.*

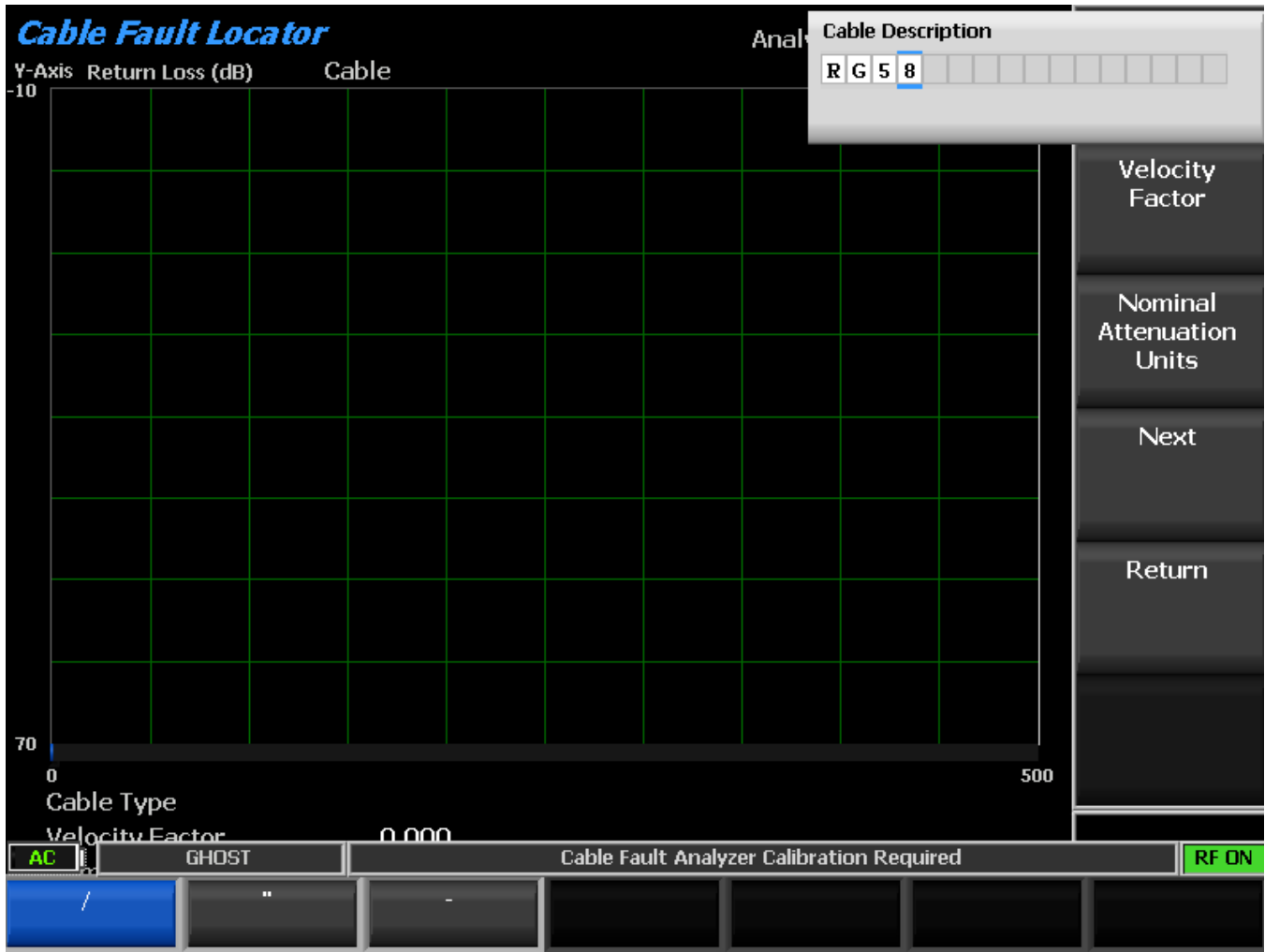

Figure 2.2.6.4-1 Cable Fault Locator Mode

The Cable Fault Locator has settings for entering cable parameters and display specifics. Several standard cable selections provide predetermined settings. A user can also enter specific data for a cable under test and save these settings for future use. See Section 4.3: Cable Fault Testing.

Cable Type

Choose from factory provided or user saved cable selections. This automatically populates the Cable Loss and Velocity Factor. If No Selection is chosen, the user should enter the specific data for the cable under test.

Center Frequency

This key sets the Cable Fault Locator Center Frequency from 250 kHz to 1 GHz in a data entry window using the arrow keys, keypad, or tuning knob. Pressing Enter completes the change, and Esc cancels the entry.

Maximum Length

This soft key sets the maximum cable length in a data entry window so that the R8100 can optimize the RF parameters and FFT calculations. The entry units are determined by the setting in the Distance Units submenu.

Analyze

This key determines the Cable Fault Locator operating mode with a horizontal soft key menu.

Off – This selection disables the Cable Fault Locator to allow parameter entry.

Continuous – The display provides continuous measurement updates.

Single Sweep – The display provides one measurement update after a key press is performed on the Single Sweep soft key.

Calibrate – The Cable Fault Locator performs a calibration to nullify effects from the RF directional coupler/splitter.

Cable Loss

This key shows the cable loss in dB per unit length at the Center Frequency for the selected Cable Type in a numeric entry window. It also allows a user to override that value or enter one for the specific cable under test. The entry units are determined by the setting in the Distance Units submenu.

Velocity Factor

This key shows the velocity factor for the selected Cable Type in a numeric entry window. It also allows a user to override that value or enter one for the specific cable under test.

Display Mode

This key selects the display presentation with the following horizontal menu choices:

Normal – The display updates continuously.

Freeze – This selection provides a display snapshot of the first measurement sweep started by a Continuous or Single Sweep key press in the Analyze submenu, then stops additional display updates. If a measurement sweep is already in process during the key press, the display updates when complete and then freezes. **Note:** *Measurement sweeps completed and displayed before the Freeze key press are not frozen and will be overwritten by the first subsequent sweep.*

Max Hold – The display retains the highest peak signal amplitudes measured during successive sweeps.

Average – The display shows a rolling average of the peak return loss amplitude measured on each successive sweep. The average consists of one to five sweeps, shown beside the mode indication.

Marker Mode

This key provides display marker control via a horizontal soft key menu.

Off – No markers are displayed.

Absolute – This selection enables one marker with peak return loss and distance readings.

Delta – This selection enables a second marker with peak return loss and distance readings. The distance between the first and second marker is shown in the main display area.

Toggle Marker

This key cycles through the available markers to select the active one (yellow) for positional adjustment on the display. The active marker is moved using the Left/Right (◀▶) cursor control buttons.

Find Peak

This key moves the cursor to the highest peak in the display window and provides a numeric readout of the distance and return loss.

Distance Units

This key select units of distance for cable length in either meters or feet.

Add Cable Type

This key allows custom entry of parameters for a user-defined cable not on the standard selection list. The soft key activates a new submenu for entering a Cable Description and the associated cable specifications. These include the cable Velocity Factor along with the Nominal Attenuation Units for three frequency points. Pressing the Next soft key advances the menu to each successive Frequency/Nominal Attenuation entry (see Figure 2.2.6.4-2). The Back soft key returns to the previous entry menu.

Once the entries are completed for three frequency points, pressing the Save New Cable soft key loads the user-defined cable into R8100 memory. The Return key brings the display back to the main Cable Fault Locator menu. The saved cable entry is now available on the Cable Type selection window.

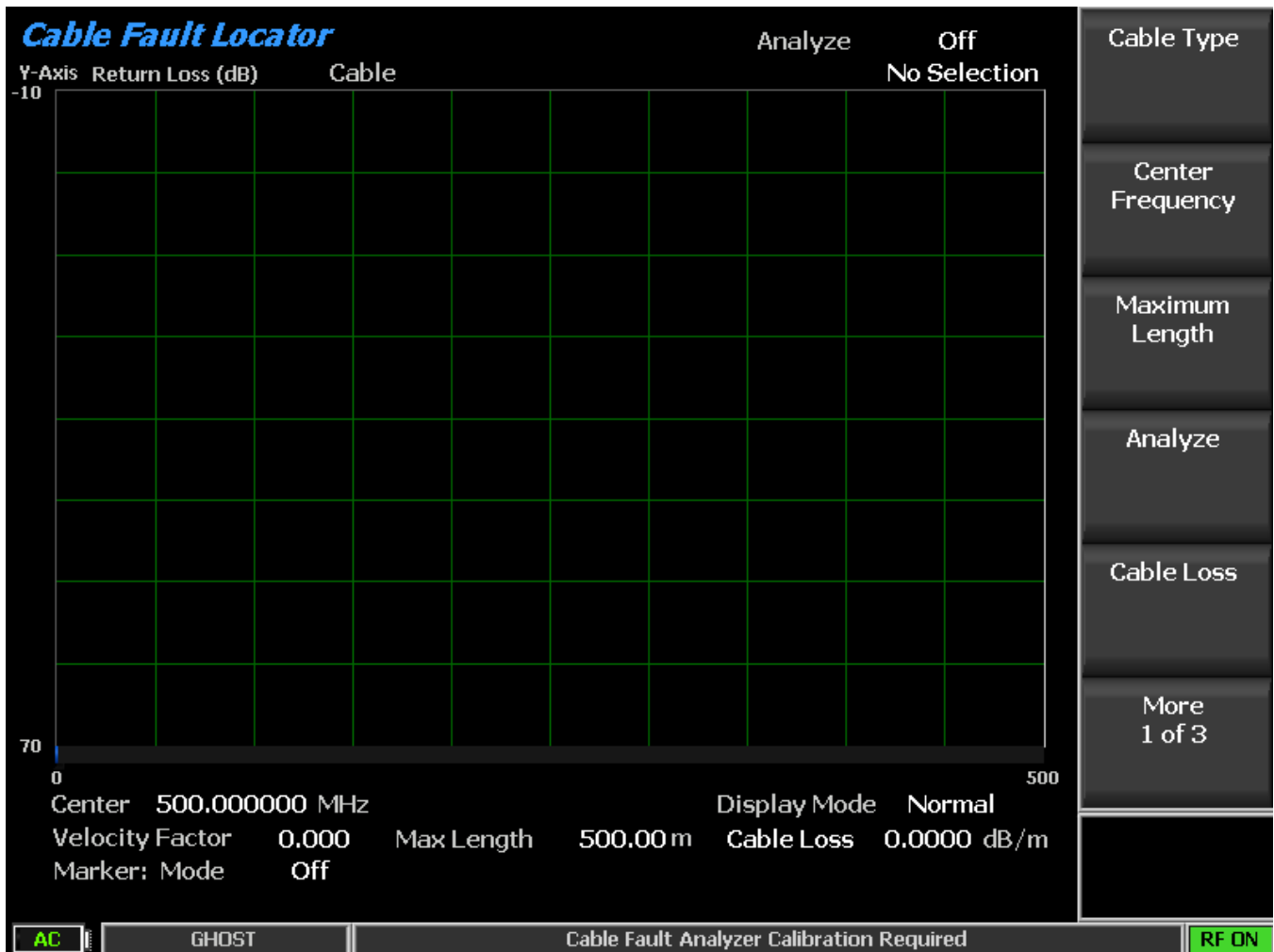

Figure 2.2.6.4-2 Frequency and Attenuation entries in the Add Cable Type submenu

Edit Cable

This key allows parameter changes for the currently selected cable type. **Note:** *This function is not available for factory provided selections.*

Delete Cable

This key removes the currently selected cable type from R8100 memory if it was stored as a user- defined cable.

2.2.6.5 Other Meters

Pressing the “Other Meters” soft key provides a shortcut to the Meter Zone operation of the R8100. The screen displays the same horizontal menu of meter selections shown when the “Select Meter” soft key in the Meter Zone is pressed.

2.2.7 Test Menu

The R8100 Test Menu provides operator presets, optional dedicated test modes for advanced transmission protocols, and optional AutoTune automated test and alignment software for manufacturer specific radios. The presets permit storage or recall of R8100 operational settings, allowing an operator to quickly recreate specific test conditions. Dedicated test modes such as DMR, P25, NXDN, dPMR and TETRA provide the ability to analyze advanced transmission protocols using digital modulation (see Section 2.2.7.2) for the supported optional protocols. The embedded AutoTune software application allows the R8100 to test and align a variety of manufactured radios without the need for an external computer. Figure 3.2.8-1 shows the submenu screen after pressing the dedicated Test navigation key.

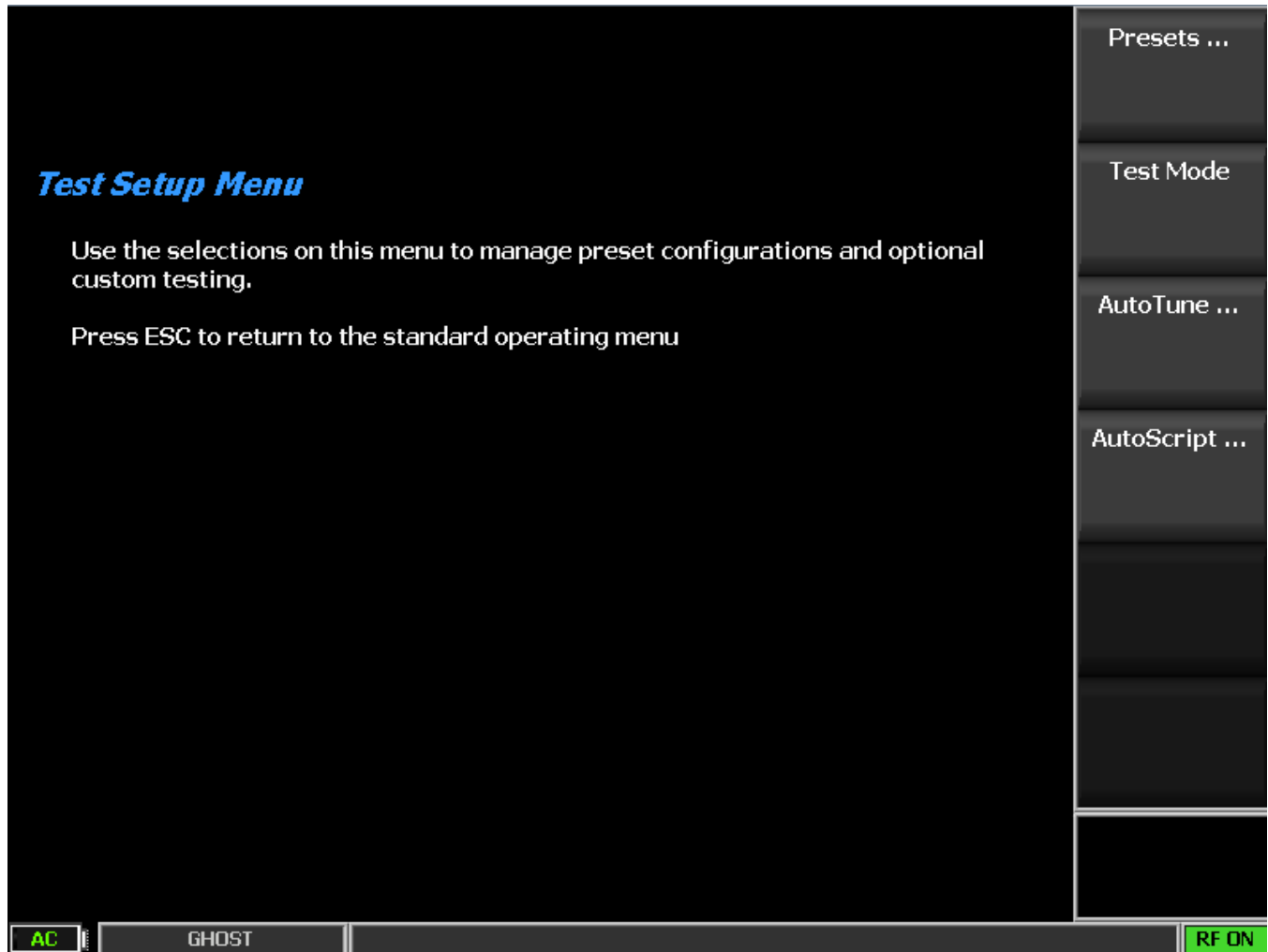

Figure 3.2.8-1 Submenu after pressing Test Navigation key

2.2.7.1 Presets

Presets are a convenient tool for storing and recalling R8100 operational settings. They are especially useful when several unique operating configurations are required in a test environment. Presets ensure a fast and accurate method of configuring the analyzer for multiple test applications. To save time and avoid errors, the R8100 can store over 100 preset operating configurations. Figure 3.2.8.1-1 shows the submenu after pressing the Presets soft key. If any Presets are present, they can be highlighted for further

action by using the Up/Down keys (▲▼) or spin knob. In Figure 3.2.8.1-1 the TEST1 Preset is highlighted (blue border).

2.2.7.1.1 Power Up Configuration

If no presets are present, the R8100 powers up in the default factory configuration. Otherwise, the power up configuration becomes that of the last Preset loaded or saved before the unit was powered down.

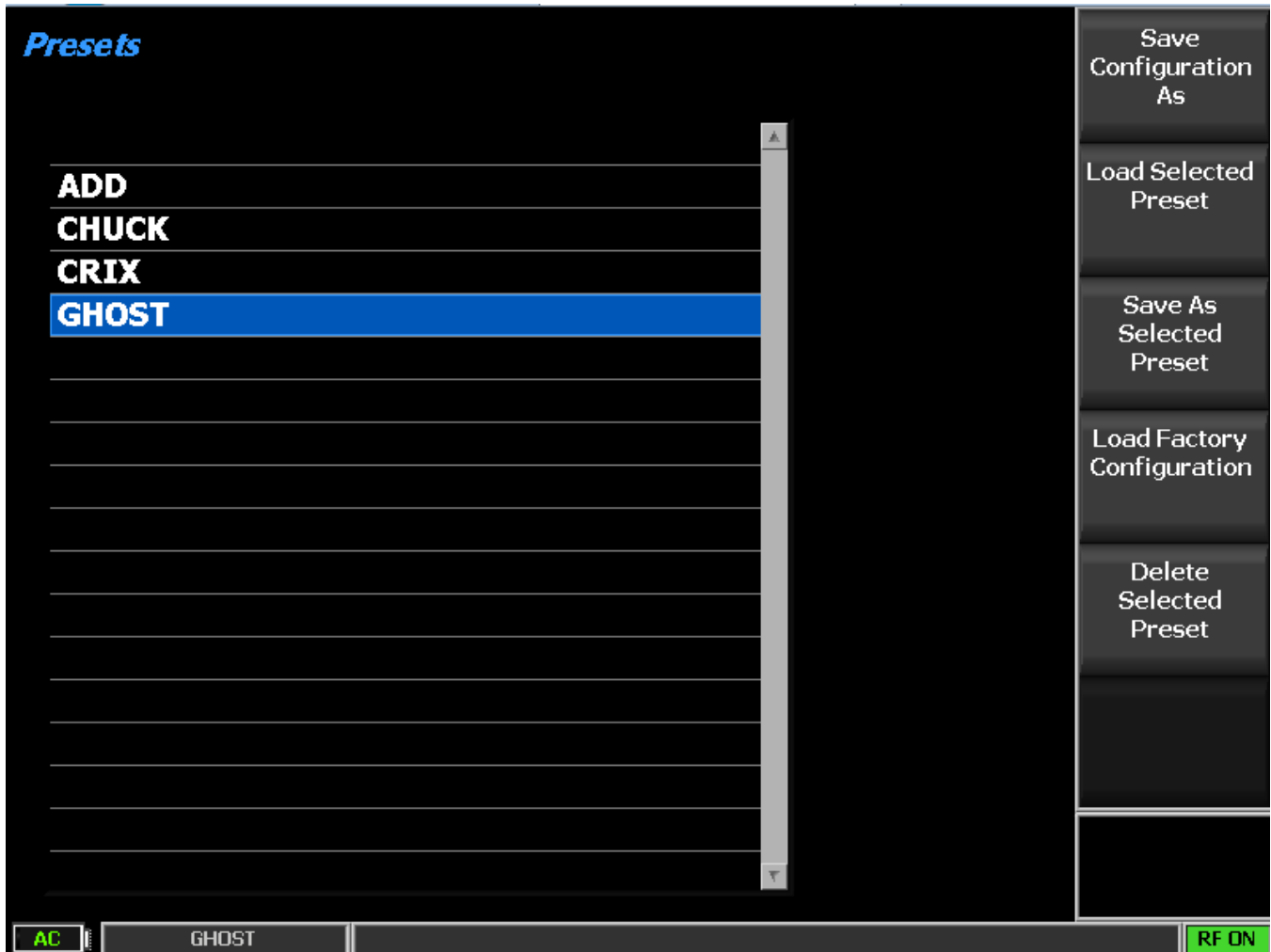

Figure 3.2.8.1-1 Submenu after pressing Presets soft key

Save Configuration As

This soft key saves the current R8100 operational settings into a memory Preset. Label the Preset in the data entry window using the Left/Right (◀▶) keys and the numeric keypad as shown in Fig 3.2.8.1-2. Cycle through the alphanumeric sequence marked on the keys with repeated keypad presses or by using the Up/Down keys (▲▼) and spin knob. Names cannot have spaces or blanks between characters. Pressing Enter adds the new Preset to the list while Esc cancels the entry.

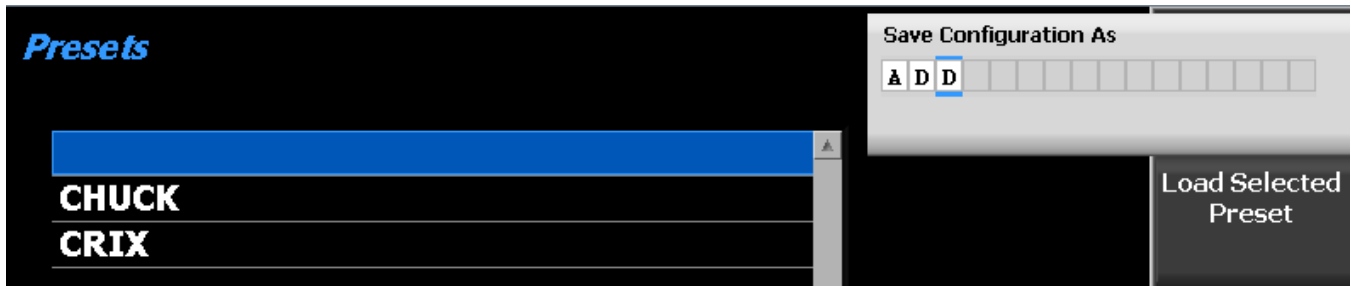

Figure 3.2.8.1-2 Data entry mode after pressing Save Configuration soft key

Load Selected Preset

Pressing this soft key configures the R8100 to the settings saved under the highlighted Preset. Use the Up/Down keys (▲▼) or spin knob to scroll through the available selections. **Note:** *The selected Preset becomes the new default configuration on power up unless a different one is chosen or saved before powering down the analyzer.*

Save As Selected Preset

Pressing this soft key saves the current R8100 operational settings to the highlighted Preset. Use the Up/Down keys (▲▼) or spin knob to scroll through the available selections. Any existing operational settings under that Preset name are overwritten by the current R8100 settings. **Note:** *The saved Preset becomes the new default configuration on power up unless a different one is chosen or saved before powering down the analyzer.*

Import Presets

This soft key imports presets from an external memory storage device attached to a USB port on the R8100.

Export Presets

This soft key saves presets stored on the R8100 to an external memory storage device attached to a USB port on the R8100.

Delete Selected Preset

This key erases the highlighted Preset from the R8100 memory.

Load Factory Configuration

This key loads and configures the R8100 to the as shipped factory settings. **Note:** *These become the default on power up unless a different Preset is loaded or saved before powering down the analyzer.*

2.2.7.2 Test Mode submenu

The Test Mode soft key displays the available transmission protocol or radio specific test modes on a horizontal submenu as shown in Figure 3.2.8.2-1. The R8100's current operating mode (e.g. Monitor or Generator) is always shown in the left tab of the message bar at the bottom of the main display, with the Test Mode shown immediately to the right. The active Test Mode is also indicated by the blue highlighted horizontal soft key in the Test Mode submenu, along with the other available test modes. The test mode options for the R8100 include the DMR (ETSI Digital Mobile Radio) protocol with Motorola

MOTOTRBO™ as the initial compliant offering, Project 25 phase 1 conventional and trunking, P25 phase 1 and phase 2, NXDN™ conventional and trunking, dPMR and TETRA. Other test mode options are under development and will be provided as firmware upgrades.



Figure 3.2.8.2-1 Test Mode submenu

2.2.7.2.1 DMR Test Mode with MOTOTRBO™

The R8100 DMR Test Package option / DMR Test Mode allows testing of repeater/subscriber radios compliant with the ETSI Digital Mobile Radio (DMR) Tier 2 conventional (non-trunked) radio transmission protocol. DMR radios use a digital transmission format employing Four-Level Frequency Shift Keying (4FSK) modulation with a channel access method of Time Division Multiple Access (TDMA) technology with two slots per frame. Pressing the DMR soft key initiates the DMR Test Mode. On the R8100 main display, the Standard Mode's Audio Zone and Audio Zone soft key are replaced by a DMR soft key and DMR specific content (see Figure 3.2.8.3-1). In addition, a Power Profile display is available in Display Zone, and a Constellation display is automatically selected in Meter Zone as a convenience.

The manufacturer's Radio Service Software (RSS), Motorola MOTOTRBO™ Radio Tuner software, is required to perform some tests in DMR Mode because certain measurements (BER) require placing the radio in a special test mode. The Tuner software places the radio in specific test modes, while the role of the R8100 service monitor is to transmit and receive test patterns compliant to the DMR physical layer. Tests that do not require RSS include subscriber slot power, Frequency Error, Symbol Deviation, FSK Error, Magnitude Error, Power Profile, and Constellation. Averaging can be applied to some measurements by the System Settings. Figure 3.2.8.3-1 shows the R8100 main screen after choosing the DMR Test Mode in Monitor Mode.

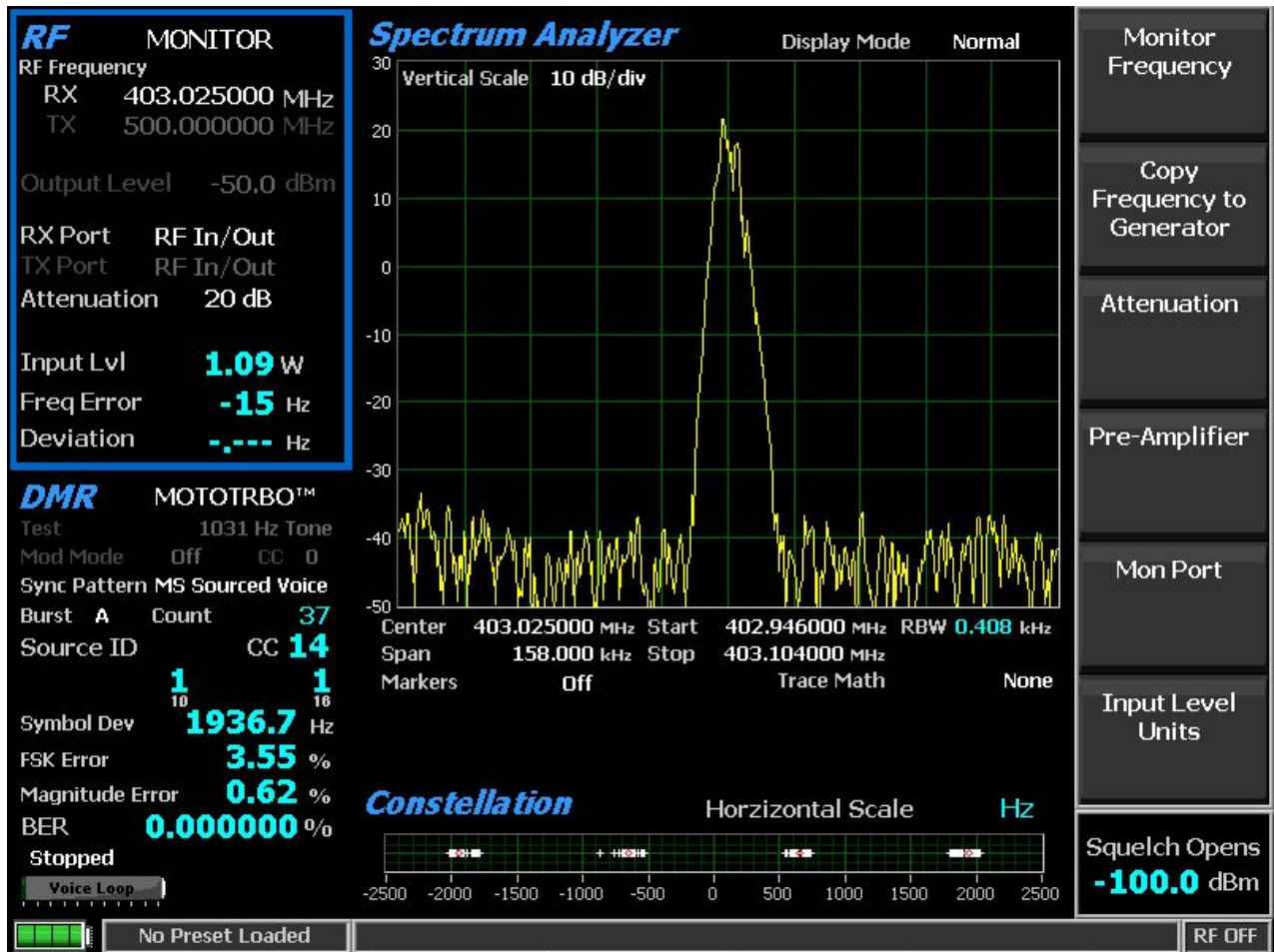

Figure 3.2.8.3-1 DMR transmitter tests

2.2.7.2.2 DMR transmitter tests

These tests are performed with the R8100 in Monitor Mode (see Figure 3.2.8.3.1-1). During repeater/subscriber radio transmission, the R8100 continuously measures the quality of the radio's transmitted 4FSK signal over the 132 symbols (264 bits) that comprise an entire DMR TDMA burst. Although the service monitor synchronizes to the first burst, it can measure the quality of any of the six bursts transmitted by the radio.

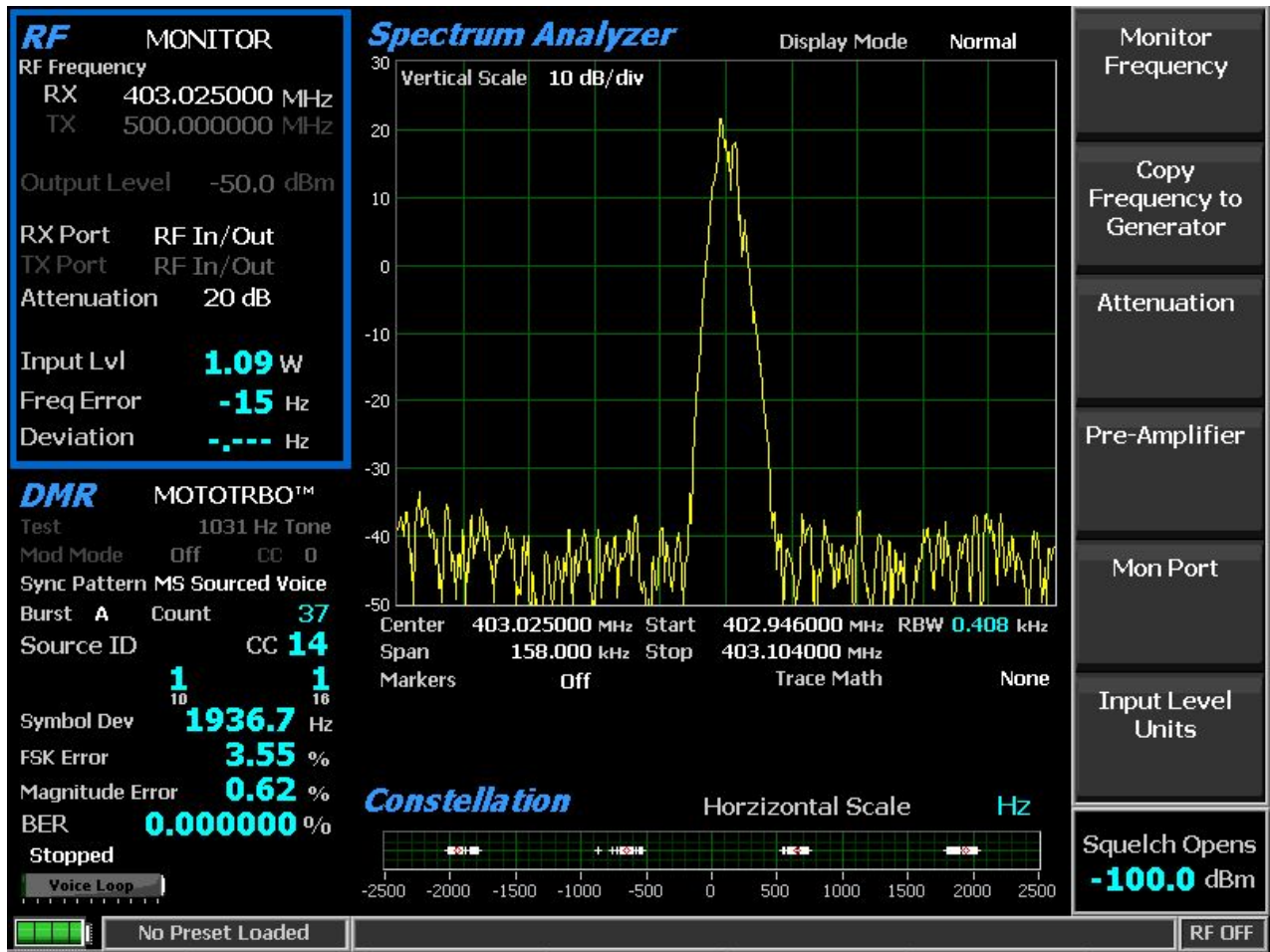

Figure 3.2.8.3.1-1 Submenu after pressing DMR soft key in Generator Mode

2.2.7.2.3 RF Zone

Input Level

Input Lvl displays the average power in the specified Burst of the synchronized TDMA slot of the received signal.

Note: Although Input Level is used for Squelch, Squelch has no effect on measurement updates.

Note: When the RF input power on the RF In/Out port is above +20 dBm (100 mW), the R8100 utilizes a broadband power detector for the measurement. The “Input Lvl” field in the RF Zone changes to “Watt Meter” to indicate this measurement mode. For best accuracy disable the Pre-amplifier in Monitor Mode, and set the Gen Port in Generate Mode to RF In/Out.

Note: The TDMA transmission alternates between a used and unused time slot, so the RF Zone field will switch between the two. An unused slot has no power, so the display will flash between “Input Lvl” and “Watt Meter.” In this condition the Input Level reading should be used since null slots can cause the Watt Meter indication to read approximately 3 dB less than the power in the used slots.

Freq Error

Freq Error displays the frequency difference of the received DMR transmission carrier minus the R8100 Monitor Frequency.

Note: *For other standard RF Zone settings, see RF Zone / Monitor Mode.*

2.2.7.2.3.1 DMR Zone

Count

This field displays increments each time the specified SYNC Pattern is detected; thus, the R8100 synchronizes to that TDMA slot.

Note: *Test measurements are only displayed if two consecutive SYNC patterns are detected; this maximizes the accuracy of the measurement.*

Source ID

Source ID displays the Source Identifier (ID), which identifies the individual address of the transmitter. This is obtained from bytes 7-9 of the Full Link Control message composed by four 32-bit embedded signaling fields at the center of bursts B to F of a voice super frame. The Source ID is displayed in base 10 and base 16 format.

CC

This field displays the four-bit color code (0 to 15) of the synchronized TDMA slot of the received signal transmission. CC is digital ID information equivalent to CTCSS/PL and CDCSS/DPL of analog FM radio systems.

Symbol Deviation

This field displays the symbol deviation estimated by averaging the normalized frequency deviations at symbol times in the specified burst of the synchronized TDMA slot of the received signal and then scaling by the maximum symbol value. The normalized frequency deviation is computed as the ratio of the actual frequency measurement at a given symbol or deviation state by the corresponding symbol value. The ideal is 1944 Hz.

FSK Error

This field displays the percentage computed from the symbols in the specified Burst of the synchronized TDMA slot of the received signal. The FSK Error is computed relative to the Symbol Deviation measurement.

Magnitude Error

This field displays the percentage computed from the symbols in the specified Burst of the synchronized TDMA slot of the received signal.

BER

This field displays the bit error rate percentage of bit differences between the O.153 pattern and the bits of the synchronized TDMA slot of the received signal. For example, if 13 of the 1296 super frame payload bits do not match the predefined pattern, the rate will be 1.0030864% ($13/1296*100\%$). Assurance of the

computation may be gained by transmitting a different calibration test pattern (e.g. BER of 1031 Hz vs. 0.153 is 47.299381%).

Brand (DMR submenu)

Choose DMR-compliant manufacturer brand for specific testing by the R8100. The tests and display may change to address unique aspects of each manufacturer’s radio series.

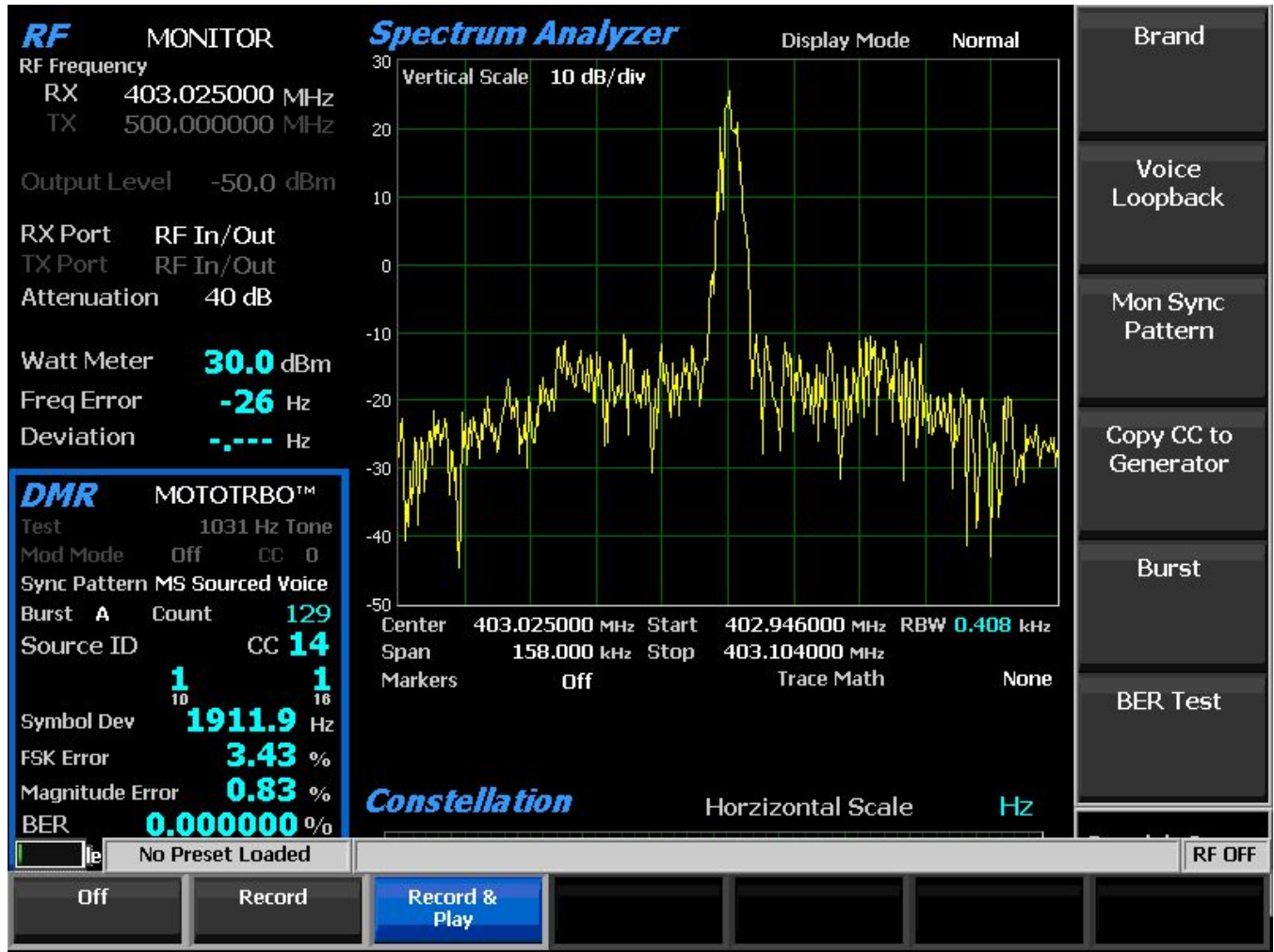

Figure 3.2.8.3.1.2-1 Voice Loopback Recording

Voice Loopback (DMR submenu)

This soft key enables the Voice Loop feature in DMR Mode (U.S. patent 5703479). Once enabled, the R8100 automatically records an input message when the radio under test transmits a signal above the squelch level setting (see Front Panel Control Knobs). A Voice Loop progress bar in the Test Mode zone is bold when Voice Loopback is enabled. The maximum length of the recording is 10 seconds, and a light green progress bar shows the recording’s progress (see Figure 3.2.8.3.1.2-1). The recording continues if the transmission is longer, but only the most recent is retained. When the radio is un-keyed, the R8100 automatically switches to Generate Mode and transmits the captured input message back to the radio (see

Figure 3.2.8.3.2-2). The position of the played back recording is displayed with a dark green progress bar. When the recorded message has been played and a three-second settling delay has passed, the Operation Mode automatically switches back to Monitor Mode so another message can be recorded. This provides a quick end-to-end test of the radio transmitter and receiver. Voice Loopback can also be used to quickly verify basic functionality of an encrypted message.

Note: *The power Input Level of the received message is readjusted to maintain the power Output Level of the transmitted message.*

Off selection stops a recording or playback and disables the feature; the progress bar is grayed out. The last recording is preserved for the remainder of the session; it is lost if the R8100 is power cycled.

Record selection (Monitor Mode only) disables the automatic switch to Generate Mode and subsequent playback. The last recording is automatically erased when a new input message is detected.

Play selection (Generate Mode only) repeatedly plays and rewinds the last recorded message; speech recorded from a transmitting radio under test should be heard from its receiver if the radio is operating properly. This setting disables the automatic switch to Monitor Mode and subsequent recording (see Figure 3.2.8.3.2-2).

Record & Play selection automatically switches from Monitor Mode to Generate Mode to play a recording. It also switches from Generate Mode to Monitor Mode to make a new recording (see Figure 3.2.8.3.2-2).

Note: *Voice Loopback overrides the Color Code (CC), Modulation Mode, and Test Pattern settings during playback. The R8100 captures and resends the Color Code, destination ID (address), and call type sent by the radio. For the radio to audibly reproduce the message, the radio must be set to a Group Call or an All Call channel.*

SYNC Pattern (DMR submenu)

This soft key chooses the data synchronization pattern for testing with the R8100, BS Sourced Voice for a base station / repeater, or MS Sourced Voice for a portable / mobile station.

Copy CC to Generator (DMR submenu)

This key sets the R8100 Generator to use the last color code that was received in Monitor Mode.

Burst (DMR submenu)

This key allows the choice of six super frame bursts for the R8100 to display radio transmitter quality measurements. Use the horizontal submenu to select the desired burst (A through F). The following measurements are made from the selected burst: Input Level, Constellation, Symbol Deviation, FSK Error, and Magnitude Error.

BER Test (DMR submenu)

This key allows for the Start or Stop Bit Error Rate (BER) testing in the DMR Mode of the R8100. This bit error rate test checks the modulation, encoding, and timing of the transmit signal during the data transmission period. When the BER Test is running, the radio transmitter under test must be placed into a Test Diagnostic Mode with the correct TX test pattern selected using the manufacturer's Radio Service Software (RSS) / MOTOTRBO™ Tuner. The test is done at nominal power with the radio transmitting the O.153 super frame test pattern into the service monitor. (It is acceptable to have an attenuator between the radio under test and the service monitor.) BER test results, the percentage of bit differences between

the O.153 pattern and the bits of the synchronized TDMA slot of the received signal, are shown in the DMR zone in the BER field.

2.2.7.2.3.2 Display Zone

Select Display (Display Zone submenu)

See Display Zone for standard selections, and see below for custom selections.

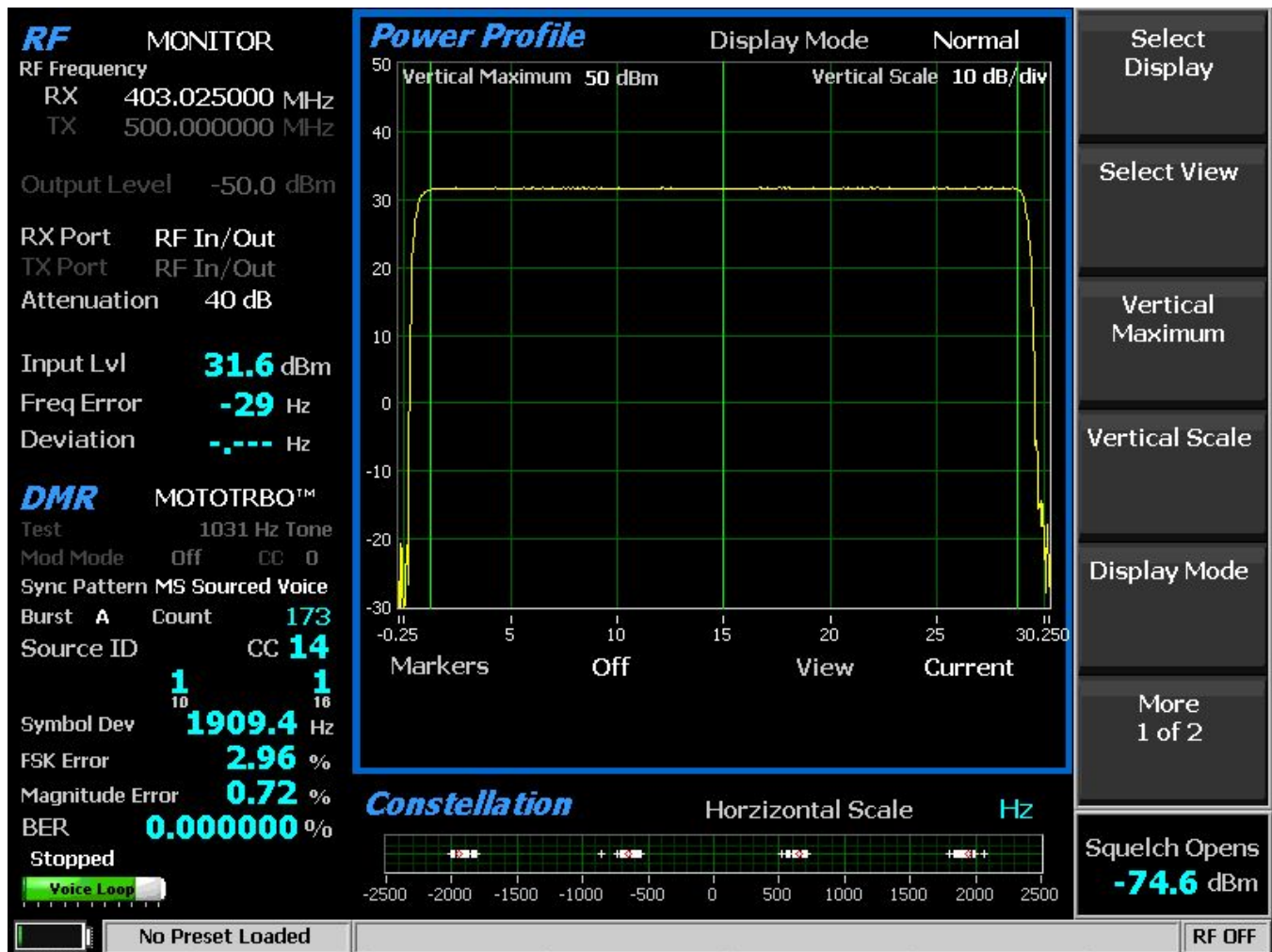

Figure 2.2.7.2.3.2-1 Power Profile Slot

Power Profile (Display Zone selection)

The power profile display provides a power versus time plot of the transmitter. The display is useful in assuring that near-far situations will not result in co-channel inter-slot interference on the alternate or non-transmission slot and that the power level will be adequate for acceptable BER performance. The scaling and position of the vertical power axis can be adjusted to inspect greater range or detail. The horizontal axis can be changed to view one or both slots including the additional ramp up/down time. Display functions and markers are available for advanced analysis. Overlays of slot centers and burst time regions are shown (see Figure 2.2.7.2.3.2-1).

Note: See the Technical Specification: ETSI TS 102 361-1 Electromagnetic compatibility and Radio spectrum Matters (ERM); Digital Mobile Radio (DMR) Systems; Part 1: "DMR Air Interface (AI) protocol," Burst timing.

Select View (Power Profile submenu)

Select the slot(s) to view. Although slots are alternating 30 milliseconds, the profile for a slot is 30.5 ms, divided into three regions for ramp-up (1.5 ms), burst (27.5 ms), and ramp-down (1.5 ms).

Current selection provides the horizontal axis -0.25 ms to 30.25 ms with slot from 0 to 30 ms.

Alternate selection provides the horizontal axis 29.75 ms to 60.25 ms with slot from 30 to 60 ms.

Both selections provide the horizontal axis -0.25 ms to 60.25 ms with slots from 0 to 30 and 30 to 60 ms. (see Figure 2.2.7.2.3.2-2).

Note: Ramp up/down times for a slot overlap the adjacent slots by 0.25 milliseconds.

Vertical Maximum (Power Profile submenu)

This key adjusts the maximum level for the vertical scale of the display (top line) from -120 dBm to +60 dBm in 1 dB increments.

Vertical Scale (Power Profile submenu)

This key selects the vertical scale resolution for the display's major grid lines from 1 dB/div to 10 dB/div via a horizontal soft key list.

Display Mode (Power Profile submenu)

This soft key selects the display presentation with the following horizontal menu choices:

Normal selection allows the display to update continuously.

Freeze selection provides a snapshot of the current display indication and stops additional updates.

Max Hold selection allows the display to retain the highest peak signal amplitudes measured during successive sweeps.

Average selection displays signal amplitudes as a rolling average of the peak amplitudes measured on each successive sweep. The average consists of one to five sweeps, shown beside the Mode indication (see Figure 2.2.7.2.3.2-2).

Marker Mode (Power Profile submenu)

This key provides display marker control via a horizontal soft key menu. Markers can be turned off or on with a choice of numeric readout for the signal measurements. "Absolute" provides actual peak readings while "Delta" measures the relative difference of both power and time between the markers (see Figure 2.2.7.2.3.2-2).

Toggle Marker (Power Profile submenu)

This key cycles through the available markers to select the active one (yellow) for positional adjustment on the display. The active marker is moved using the Left/Right (◀▶) cursor control buttons.

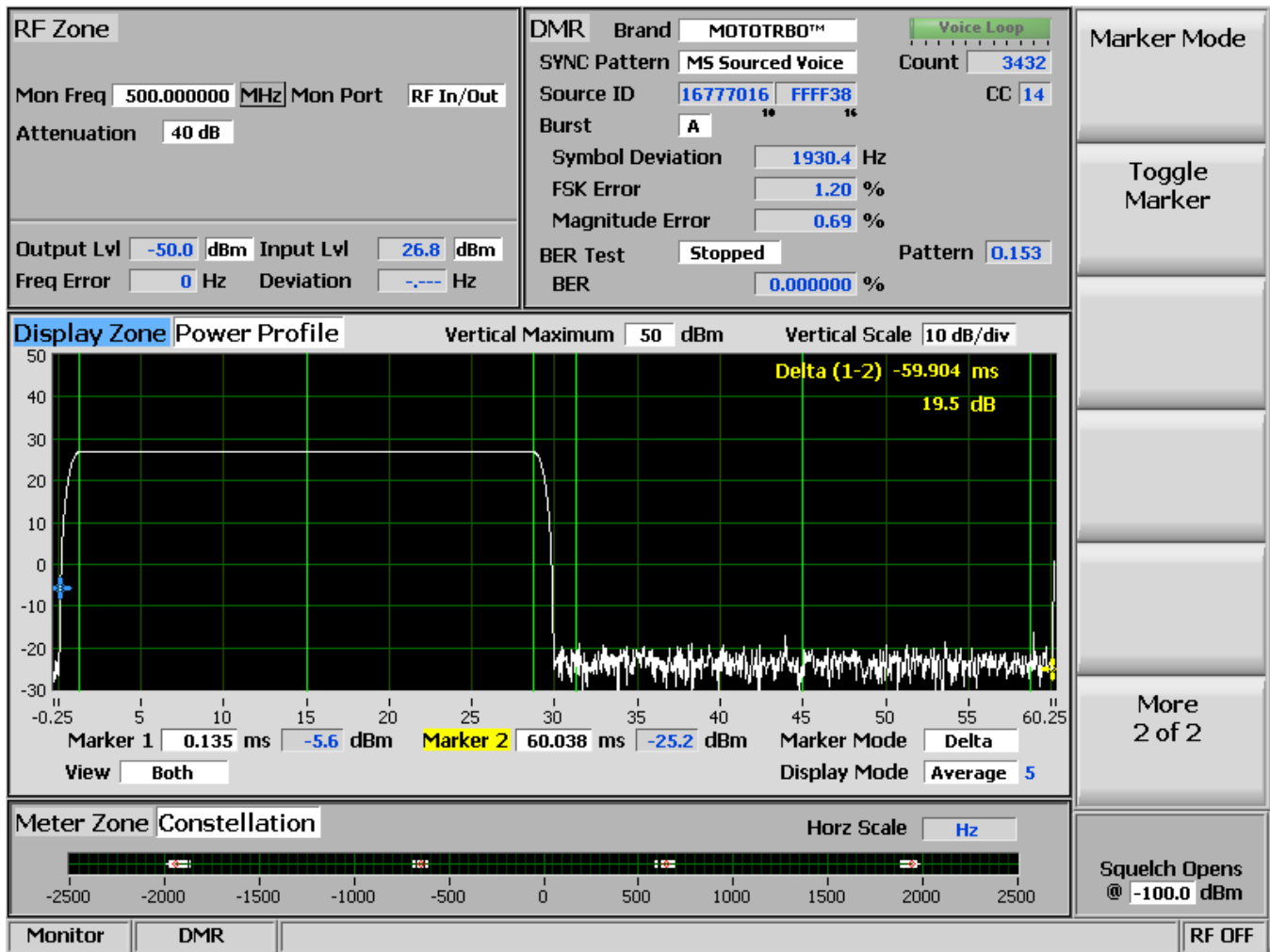

Figure 2.2.7.2.3.2-2 Power Profile Frame with Markers

2.2.7.2.3.3 Meter Zone

Select Meter

See Meter Zone for standard selections, and see below for custom selections.

Constellation (Meter Zone selection)

The Constellation display provides a visual representation of overall transmitter operation (see Figure 3.2.8.3.1-2). DMR radios broadcast voice and data using four frequency shift deviations of the carrier to represent symbols containing two data bits. Four red tick marks on the display represent the expected locations for the deviation states when the radio is transmitting data bit symbols using the modulation. White bars show the actual deviation measurement at symbol decision times. A tighter grouping around the red tick marks indicates more accurate transmitter performance.

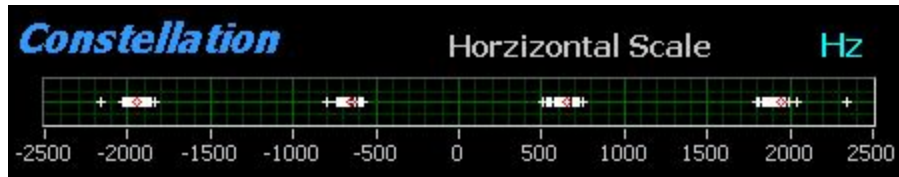

Figure 2.2.7.2.3.3-1 Submenu after pressing DMR soft key in Monitor Mode

The nominal deviation points for each data symbol are as follows:

Bits	Symbol	Deviation
01	+3	+1944 Hz
00	+1	+648 Hz
10	-1	-648 Hz
11	-3	-1944 Hz

Table 2.2.7.2.3.3-1 DMR Symbols

2.2.7.2.4 DMR receiver tests

DMR receiver tests are performed with the R8100 in Generate Mode, and protocol-specific tests are accessed with the DMR soft key (see Figure 3.2.8.3.2-1). The R8100 generates DMR-compliant test patterns and can be adjusted over a wide range of RF levels to determine the sensitivity and data transmission integrity of the DMR radio. DMR submenu selections are as follows:

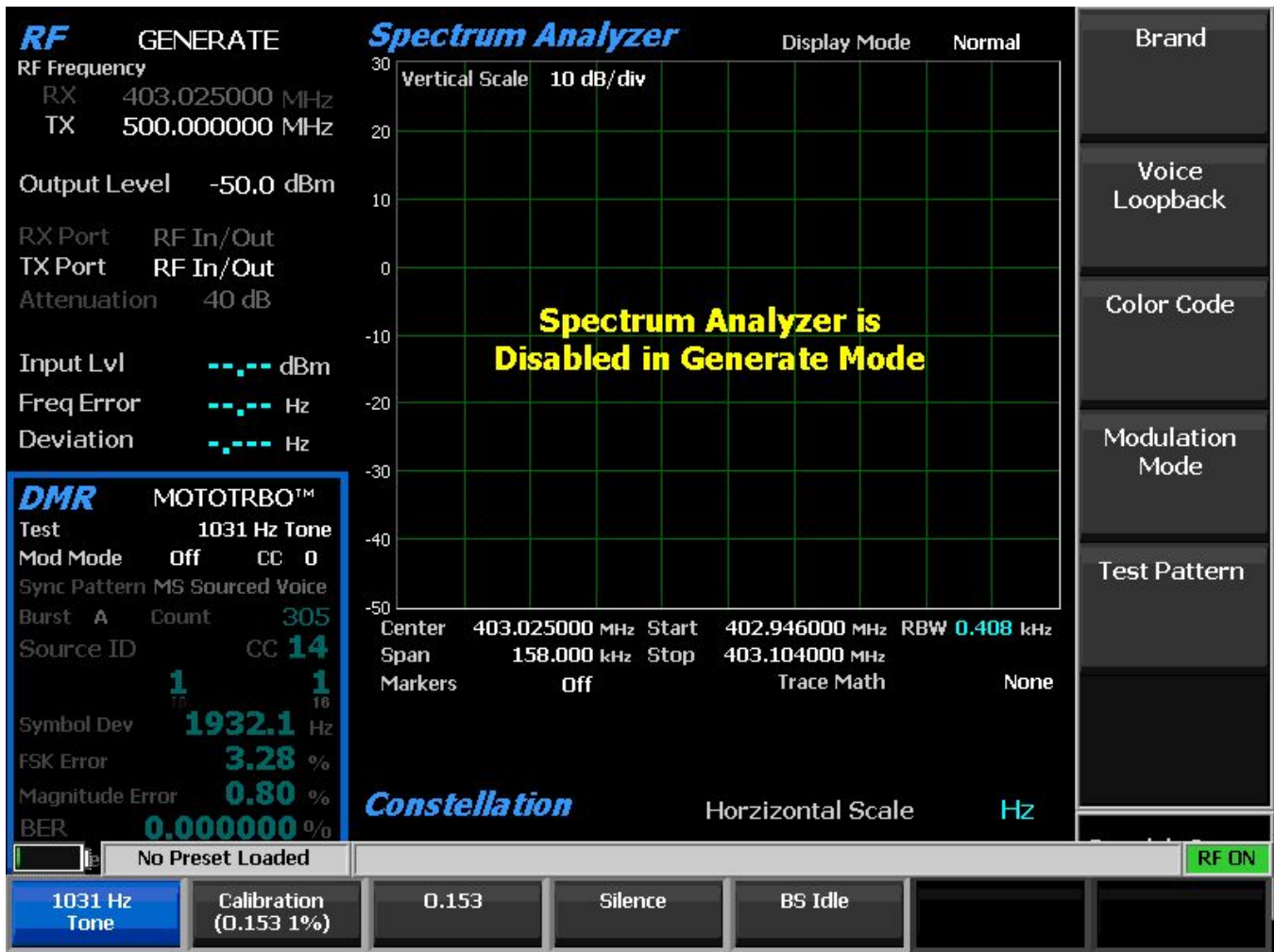

Figure 3.2.8.3.2-1 Submenu after pressing DMR soft key in Generate Mode

Brand

Choose DMR-compliant manufacturer brand for specific testing by the R8100. The tests and display may change to address unique aspects of each manufacturer’s radio series.

Voice Loopback

Off selection stops playback.

Play selection allows the last recorded message to be repeatedly played and rewound. **Note:** *Voice Loopback overrides the Modulation Mode.*

See transmitter tests Section 2.2.7.2.3.1 for complete instructions.

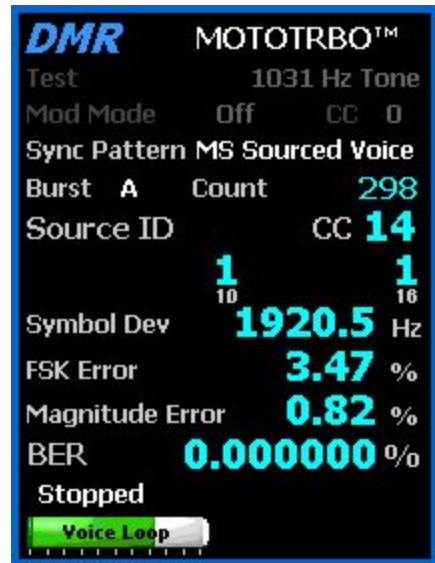

Figure 3.2.8.3.2-2 Voice Loopback Playing

Color Code

Select one of 16 color codes (0 to 15) to match that of the radio or base station for the specific channel frequency being tested. Although the R8100 can analyze a transmission with any color code, radios will only accept a transmission whose color code matches its own (unless the radio is in a test diagnostic mode that ignores the color code).

Modulation Mode

A horizontal submenu provides choice of Off or Continuous for the selected Test Pattern modulation.

Test Pattern

This field specifies the DMR-compliant test pattern generated by the R8100 to assess voice performance or test data transmission accuracy using BER measurements. When performing the BER test, the radio receiver under test must be placed in a Test Diagnostic Mode with the correct RX test pattern selected using the manufacturer's Radio Service Software (RSS) / MOTOTRBO™ Tuner to enable it to calculate BER internally. The calculated BER is then displayed by the radio or on the computer (as is the case for MOTOTRBO™ Tuner). For sensitivity tests, the R8100 can transmit a super frame test pattern, O.153 (V.52) for example, over its entire output power level range. This provides a measurement of the reference sensitivity (1% or 5% BER) for the radio. A horizontal submenu provides the following DMR compliant patterns:

1031 Hz Tone is a predefined super frame test pattern compatible with digital vocoder type AMBE+2™ that produces a 1031 Hz tone at the speaker of the receiver vocoder. It can be used to quickly check audio performance in the field.

Calibration (O.153 1%) is a test pattern transmitted at the defined power level. -60 dBm for example, is used to verify internal BER calculations are operating correctly. The 1% BER super frame test pattern

changes the value of every 100th O.153 information bit and the very last bit to yield 13 bit errors out of 1296 O.153 information bits (precisely 1.0030864%).

O.153 is a super frame test pattern based on ITU-T O.153 (formerly CCITT V.52) used to perform BER calculations.

Silence is a predefined super frame test pattern compatible with digital vocoder type AMBE+2™ that results in a silent output at the receiver vocoder.

Note: *All patterns have the all-call destination with broadcast service option as a convenience to eliminate the need to reprogram the radio's ID.*

2.2.7.3 PROJECT 25 Test Mode (Conventional)

The optional R8100 PROJECT 25 (P25) Test Mode allows testing of conventional (non-trunked) APCO Project 25 phase 1 (P25) compliant mobile stations (radios) and base stations (repeaters) in simplex and duplex modes. P25 radios use a digital transmission format employing Continuous 4 level FM (C4FM) modulation. P25 repeaters may also transmit LSM (Linear Simulcast Modulation) and WCQPSK (wide Continuous Quadrature Phase Shift Keying) modulation schemes, which are compatible with C4FM receivers. The R8100 PROJECT 25 Mode provides a grouping of test functions compliant with the TIA/EIA-102.CAAA measurement standard. These include symbol deviation, modulation fidelity, Bit Error Rate (BER) test patterns, Frequency Error, and Power. A means is provided to change the Network Access Code (NAC) and edit the P25 Voice Frame to adapt to the system under test. In addition, an Eye Diagram with graphical representation of the P25 signal exists, and a Voice Loopback function that enables the Voice Loop feature (U.S. patent 5703479) for audio verification of the radio's end-to-end operation.

The manufacturer's Radio Service Software (RSS) is required to perform some tests in P25 Mode because certain measurements (BER) require placing the radio in a special test mode. Tests that do not require RSS include power, Frequency Error, Modulation Fidelity, Symbol Deviation, and Symbol Rate Error. Averaging can be applied to some measurements by the System Settings. The Eye Diagram, Constellation Plot, Distribution Plot, and Voice Loopback also provide qualitative indication of the radio's performance. Figure 3.2.8.4-1 shows the R8100 main screen after choosing the PROJECT 25 Test Mode in Monitor Mode.

2.2.7.3.1 P25 Transmitter Tests

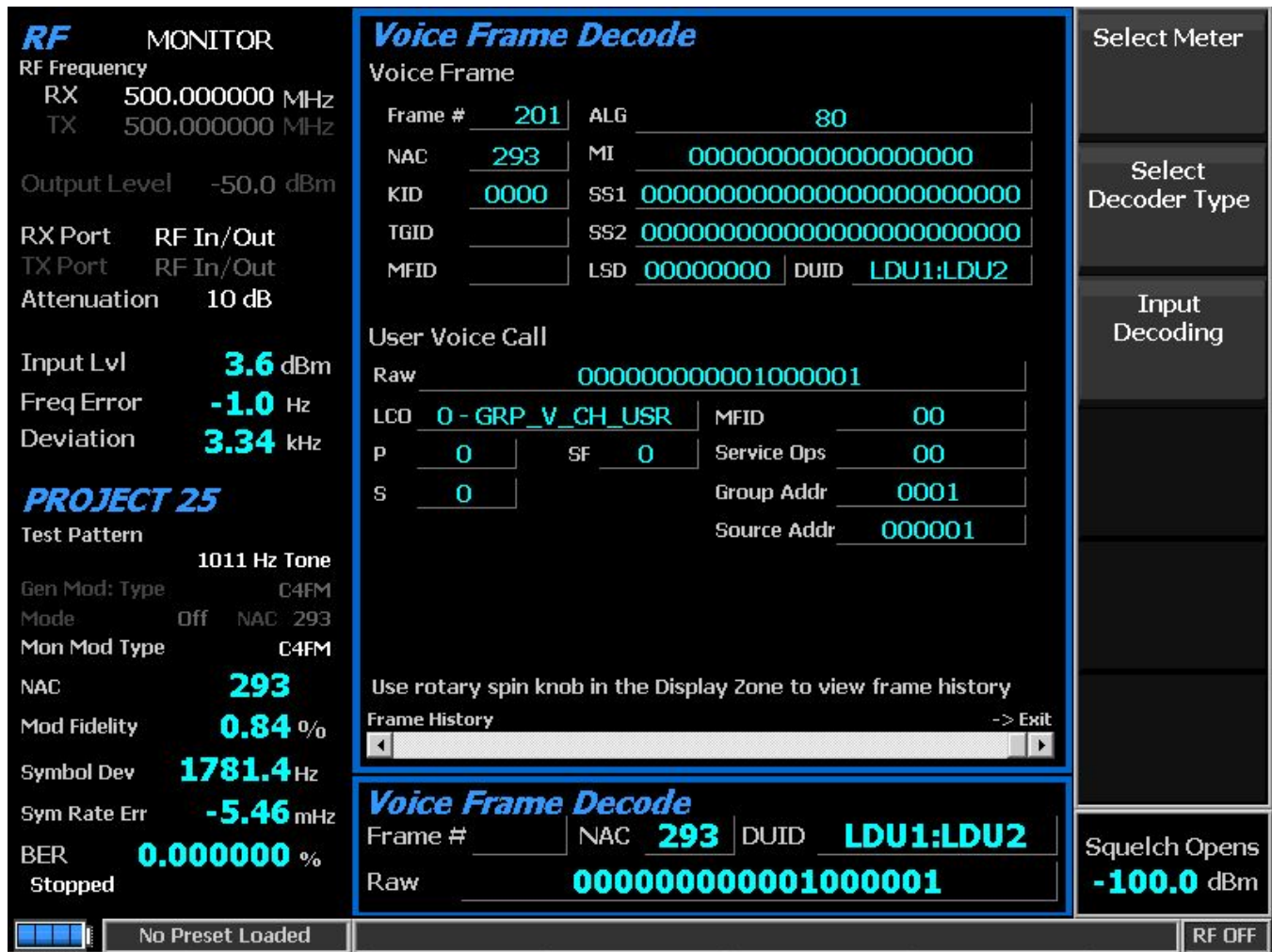

Figure 2.2.7.3.1-1 Main screen in Monitor Mode Voice Frame Decode

P25 Transmitter tests are performed with the R8100 in Monitor or Duplex Mode, and protocol-specific tests are accessed with the PROJECT 25 soft key (see Figure 2.2.7.3.1-1). For Bit Error Rate (BER) testing, the manufacturer’s RSS software is required. This configures the radio in a special test mode for transmitting TIA/EIA-102.CAAA compliant test patterns such as 1011 Hz Tone, Calibration, Standard Tx (O.153/V.52), etc.

The TIA/EIA-102.CAAA compliant test patterns provided in the R8100 may be classified into two groups: read-only and modifiable. The read-only test patterns include the Standard Tx (O.153/V52), Symbol Rate, Low Deviation, C4FM Mod Fidelity patterns, and Calibration. With the exception of Calibration, these patterns are all defined in the standard without a NAC field. Therefore, it would not be appropriate for the R8100 to allow the NAC value to be changed. Additionally, Calibration is defined in the standard with a fixed NAC value of 293 that may not be edited. In contrast, modifiable test patterns include 1011 Hz Tone and Silent because they contain parameters (NAC, VoiceFrame field) that may be edited by the user.

The tests performed are as follows:

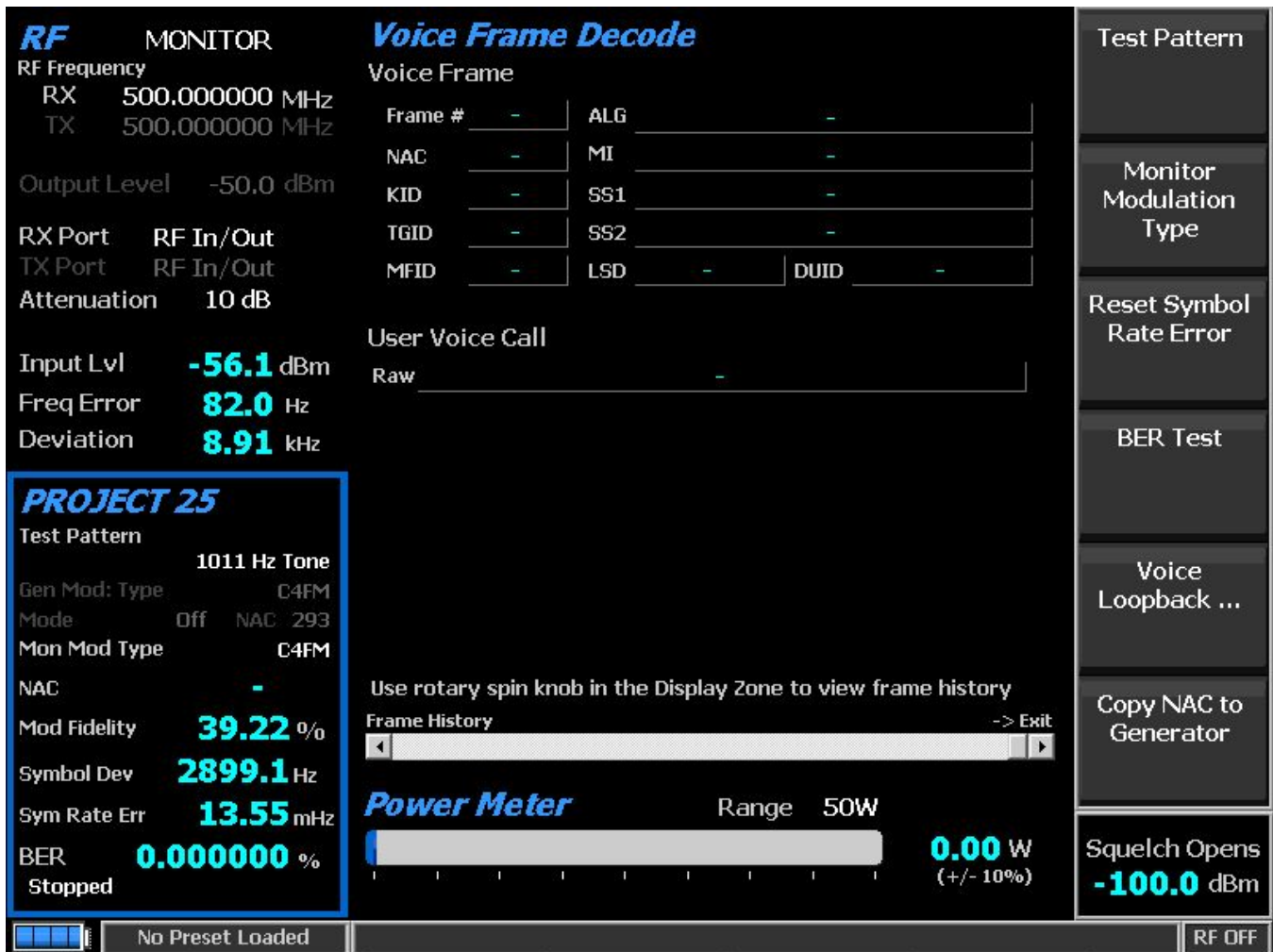

Figure 2.2.7.3.1-2 Main screen in Monitor Mode after pressing the PROJECT 25 soft key

2.2.7.3.1.1 RF Zone

Input Level (RF Zone display)

Input Lvl displays the average power in the P25 channel under test.

Note: When the RF input power on the RF In/Out port is above +20 dBm (100 mW), the R8100 utilizes a broadband power detector for the measurement. The “Input Lvl” field in the RF Zone changes to “Watt Meter” to indicate this measurement mode. For best accuracy disable the Pre-amplifier in Monitor Mode, and set the Gen Port in Generate Mode to RF In/Out.

Freq Error (RF Zone display)

Freq Error displays the frequency difference of the received P25 transmission carrier minus the R8100 Monitor Frequency.

Deviation (RF Zone display)

This field displays the positive peak FM frequency deviation of the received modulated carrier (i.e. from the Frequency Error mean). See negative peak frequency deviation with Display Zone Bar Graphs.

2.2.7.3.1.2 PROJECT 25 Zone

Test Pattern (P25 submenu)

This soft key provides selection for one of four TIA/EIA-102.CAAA compliant predefined test patterns for BER testing of a P25 radio in Monitor Mode as shown in Figure 2.2.7.3.1.2-1. The following patterns are available:



Figure 2.2.7.3.1.2-1 Test Pattern submenu in P25 Monitor Mode

1011 Hz Tone selects the standard tone framed test pattern of the 1011 Hz vocoder tone.

Calibration (Tone 5%) selects the test pattern derived from the standard 1011 Hz Tone test pattern to verify BER measurements are operating correctly. Every 20th bit is inverted to yield 172 errors out of 3456 bits resulting in a 4.976852% BER.

Standard Tx (O.153/V.52) selects the standard transmitter test pattern of continuously repeating 511-bit pseudo random number sequences based on ITU-T O.153 (formerly CCITT V.52).

Silence selects the framed test pattern for silence at the vocoder.

Monitor Modulation Type (P25 submenu)

Select the expected type of modulation of the received signal to be analyzed: C4FM, LSM, or WCQPSK. The type specified is used in the Display Zone to enable selection of the Constellation Plot for complex modulation types (LSM and WCQPSK); it is also used by the Eye Diagram for horizontal positioning.

Modulation Fidelity (P25 Zone display)

Modulation Fidelity (FSK error) represents how accurate a P25 transmitter reproduces an ideal theoretical modulation waveform. The measurement is performed by first removing frequency error and symbol deviation gain error from the received signal, then computing the RMS difference between the deviation of the resulting signal at each symbol decision point and the ideal deviations of those symbols; no bit errors should be detected. On the R8100 this is computed over a 72 symbol interval and reported as an RMS error in % relative to the mean deviation across symbols.

NAC (P25 Zone display)

The Network Access Code is displayed as hexadecimal 000 to FFF and decoded from the P25 embedded signaling data in the voice frames of the radio or system under test. NAC is digital ID information equivalent to CTCSS/PL and CDCSS/DPL of analog FM radio systems. The R8100 can receive transmissions from a radio under test programmed with any NAC, but the radio requires the R8100 to transmit the specific NAC programmed into the radio. See “Copy NAC to Generator” to configure the R8100 to transmit back to that radio.

Symbol Deviation (P25 Zone display)

P25 radios broadcast voice and data using a four level frequency deviation of the carrier to represent symbols containing data bits as shown in the table below. The nominal deviation value for a Project 25 radio using C4FM modulation is 1800 Hz. Since the deviation of a Project 25 C4FM signal is data dependent, that aspect is factored when measuring overall carrier deviation. The Symbol Deviation field provides the deviation measurement at symbol decision times.

Bits	Symbol	Deviation
01	+3	+1800 Hz
00	+1	+600 Hz
10	-1	-600 Hz
11	-3	-1800 Hz

Table 2.2.7.3.1.2-1 P25 Symbols

Symbol Rate Error (P25 Zone display)

The Symbol Rate Error is a measurement of the transmitter symbol rate accuracy, the difference of the actual minus the ideal. Thus, a positive error indicates that the transmitter clock is too fast. P25 standard TIA-102.CAAB-B 3.2.17 Symbol Rate Accuracy states that the symbol rate error shall not exceed 10 PPM, which is +/- 48 mHz given the ideal symbol rate of 4800 baud. The measurement is designed to provide much better accuracy by continually refining the measurement over time. A Reset Symbol Rate Error soft key is provided to restart the measurement.

Reset Symbol Rate Error (P25 Zone submenu)

The Symbol Rate Error measurement is restarted. This is necessary after the input signal changes, i.e. is discontinuous from when the measurement was started.

BER Test (P25 submenu)

BER Test starts or stops Bit Error Rate (BER) testing in the P25 Mode of the R8100. When performing the BER test, the radio transmitter under test must be placed in a test diagnostic mode using the manufacturer's Radio Service Software (RSS). The transmission is compared against the Test Pattern specified in the P25 submenu. BER test results are shown as an error in % in the PROJECT 25 Zone (see Figure 2.2.7.3.1.2-1).

BER (P25 Zone display)

See BER Test above.

Voice Loopback (P25 submenu)

This menu selection enables the Voice Loop feature in P25 mode (U.S. patent 5703479). Once enabled the R8100 automatically records voice channel data when the radio under test transmits a signal above the squelch level setting. A green Voice Playback Active indicator appears in the Test Mode Zone when Voice Loopback is enabled on the Voice Loopback screen (see Figure 2.2.7.3.1.3-3). The Record Duration setting determines the maximum length of the recording, and a bar graph meter shows the recording's progress (see Figure 2.2.7.3.1.2-2). The recording continues if the transmission is longer than the duration, but only the most recent is retained. When the radio is un-keyed, the R8100 automatically

switches to Generate Mode and transmits the captured voice channel information or speech back to the radio (see Figure 2.2.7.3.1.2-3). This provides a quick end-to-end test of the P25 radio transmitter and receiver. Also, while complete P25 encryption radio support will be an upcoming R8100 feature, Voice Loopback can presently be used to quickly verify basic functionality of an encrypted P25 radio. **Note:** *The R8100 captures and resends the Network Access Code (NAC) sent by the radio. For the radio to reproduce the voice loopback, the receive NAC must be the same as the transmit NAC. Also, radios configured for private calls requiring a selective squelch ID equal to that of the radio may not loop back.*

Voice channel recordings can be replayed at any time by pressing the Play Last Recording soft key. (This selection only appears after a recording has been made.) **Note:** *Recorded information is lost if the R8100 is power cycled or if the Generate Mode is selected and a new test pattern is enabled by setting the Modulation Mode to Continuous or Burst.*

If the Generate Modulation Type is changed during voice loop playback, the new type will not take effect until the next playback (i.e. it won't change mid-playback). However, the last recording will be generated back with the new type the next time it is played back.

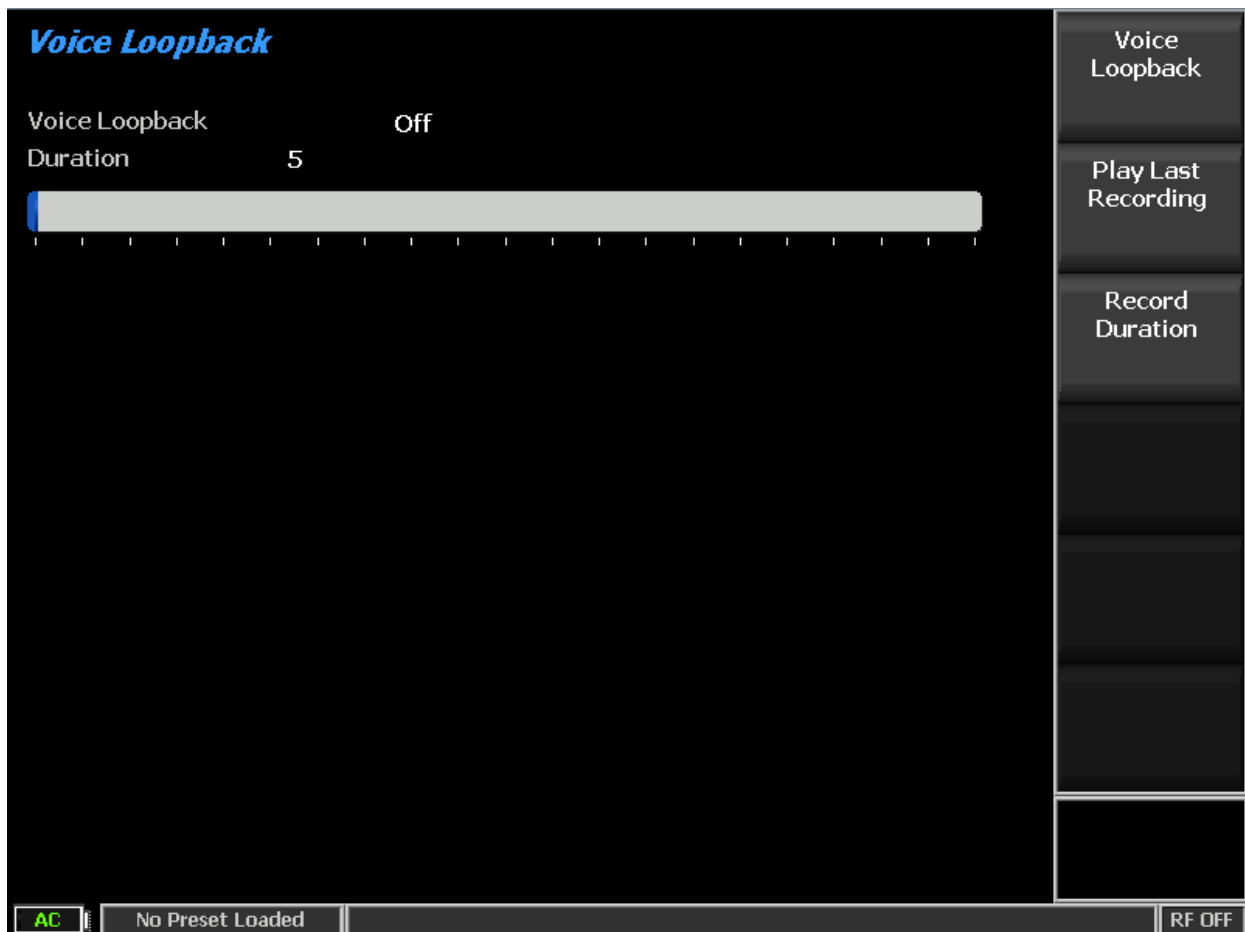

Figure 2.2.7.3.1.2-2 P25 Voice Recording

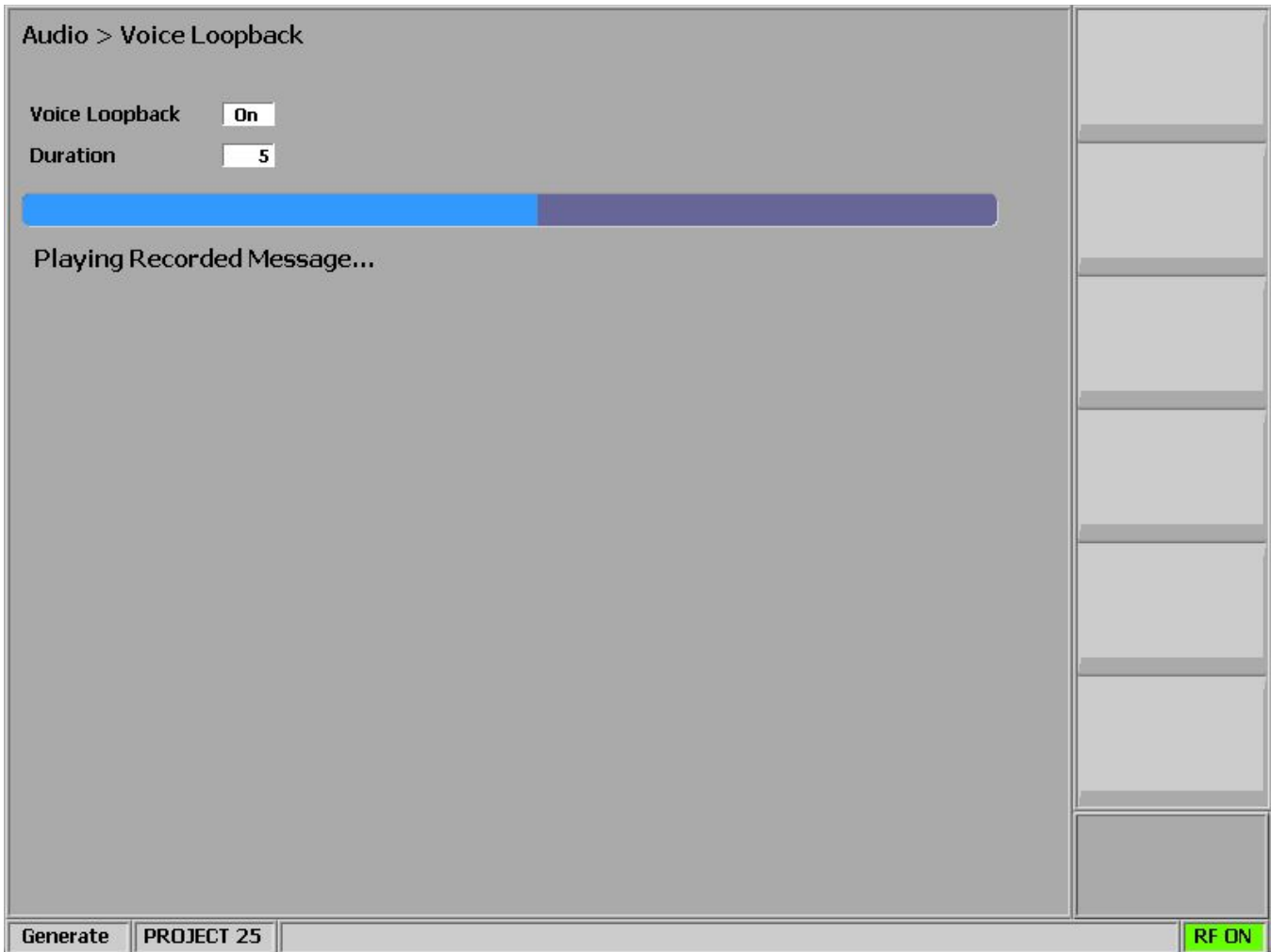

Figure 2.2.7.3.1.2-3 P25 Voice Loopback

Play Last Recording (Voice Loopback submenu)

This selection appears only after a recording has been made. Pressing the soft key places the R8100 in Generate Mode and modulates the carrier with the most recently recorded voice channel data after the Voice Loopback function is enabled. The total transmission time is equal to the length of recorded data, and a bar graph indicates the remaining transmission time during playback. Speech recorded from a transmitting P25 radio under test should be heard from its receiver if the radio is operating properly.

Record Duration (Voice Loopback submenu)

This key sets the maximum length of a recording. The time can be varied from one to 10 seconds in a data entry window using the arrow keys, keypad, or spin knob. If the transmission is longer than this time, only the most recent is retained.

Copy NAC to Generator (P25 submenu)

Set the R8100 voice frame encoder's Network Access Code to the decoder's received NAC for transmission back to a radio under test. The R8100 can receive transmissions from a radio under test

programmed with any NAC, but the radio requires the R8100 to transmit the specific NAC programmed into the radio.

2.2.7.3.1.3 Display Zone

Select Display (Display Zone submenu)

See 2.2.4: Display Zone for standard selections, and see below for custom selections.

Eye Diagram (Display Zone selection)

The Eye Diagram provides a visual display of the received P25 signal and overlays the modulation response during two symbol periods over the four “target” crossing points for an ideal P25 signal (see Figure 2.2.7.3.1.3-1). The Eye Diagram can indicate whether a transmitter has significant unbalances or offsets in the modulation circuitry by noting how tightly grouped the waveform is around the crossing points. Be sure that the Monitor Modulation Type in the PROJECT 25 Test Zone is set for the expected receive signal in order to establish the appropriate symbol timing used to position the diagram on the horizontal axis.

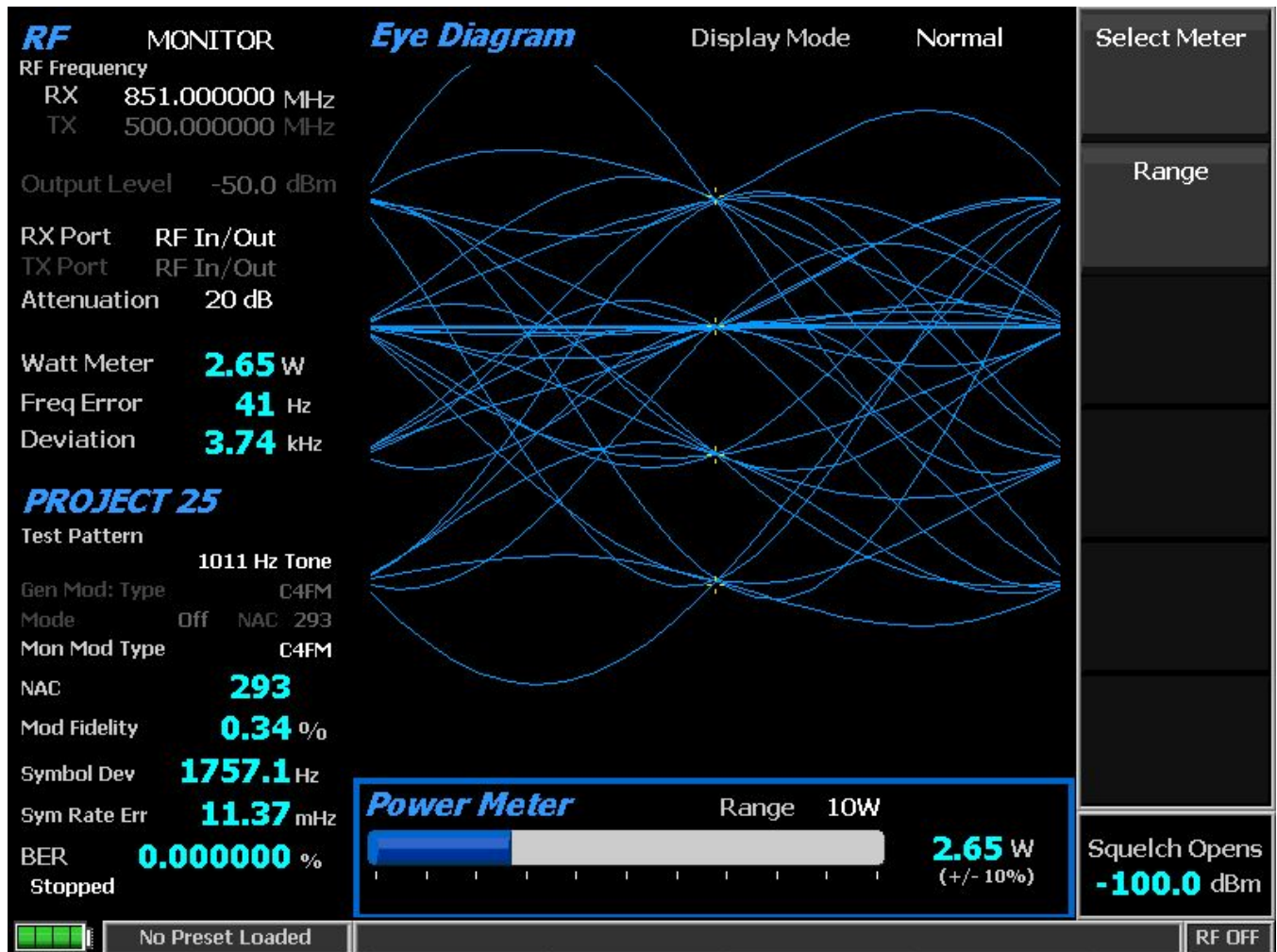

Figure 2.2.7.3.1.3-1 P25 Eye Diagram selection in Display Zone

Display Mode (Eye Diagram submenu)

Display Mode selects the display presentation with the following horizontal menu choices:

Normal selection allows the display to update continuously.

Fade Away selection is similar to the Persistence Mode on an oscilloscope (see Figure 2.2.7.3.1.3-2). The intensity of each trace fades away or decays as new traces are received. The effect is to intensify the display in the area where the waveform spends most of its time. **Note:** *Whenever the Display Mode is changed, the R8100 reconfigures the presentation. This process takes approximately 10 seconds and is complete when the new setting appears in the Display Mode field.*

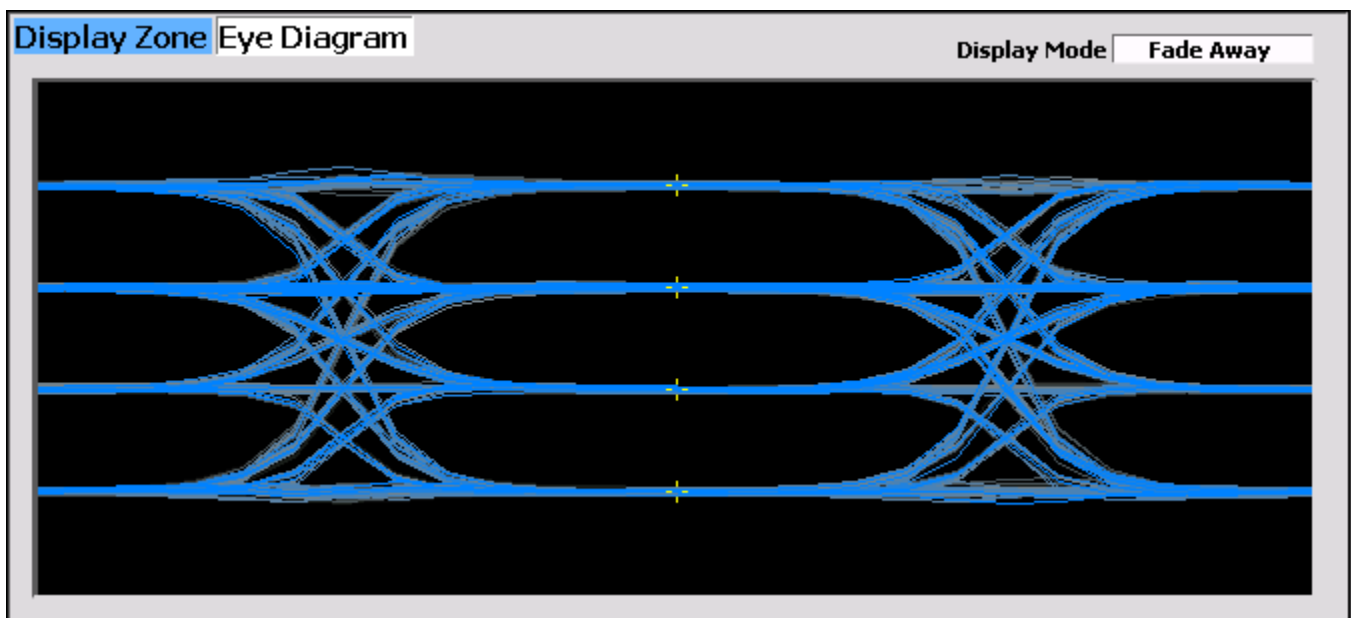

Figure 2.2.7.3.1.3-2 Eye Diagram with Mon Mod Type WCQPSK and Display Mode Fade Away

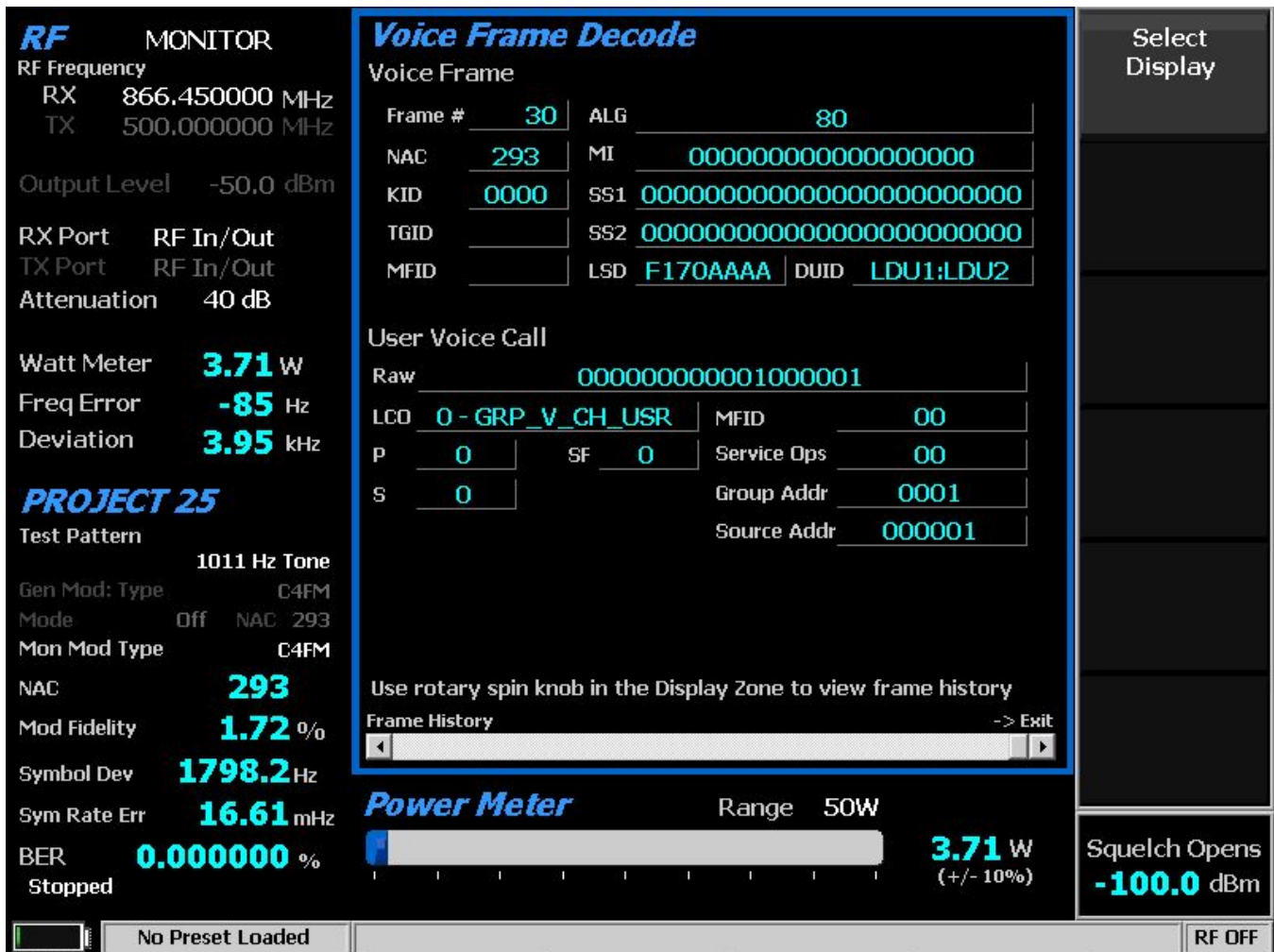

Figure 2.2.7.3.1.3-3 P25 Voice Frame Decode

Note: The Voice Frame header's TGID and MFID are not displayed; see the User Voice Call fields for the Link Control code word's Group Address and MFID, if applicable.

Voice Frame Decode (Display and Meter Zone selections)

Choose this decode function in either the Display Zone or Meter Zone (which displays a subset of the information and selects the Display Zone automatically). The Voice Frame Decode display provides the decoded data from the P25 embedded signaling. Rotate the spin knob CCW to view the frame history in the Display Zone (Frame # indicates the position); Clockwise exits history. The Voice Frame fields are from the header word and interspersed status symbols.

Field	Mnemonic	Bits	Note
Network Identifier	NID	16	
Network Access Code	NAC	12	
Data Unit ID	DUID	4	See Table 2.2.7.3.1.3-3
Header Word		120	
Message Indicator	MI	72	Encryption is not supported
Manufacturer's ID	MFID	8	Not displayed
Algorithm ID	ALG	8	Encryption is not supported; 80 is unencrypted
Key ID	KID	16	Encryption is not supported
Talk-group ID	TGID	16	Not displayed
Link Control	LC	72	Format varies
Format	LCF	8	
Protected flag	P	1	Encryption is not supported
Standard Format	SF	1	
Opcode	LCO	6	
Content		56	
Low Speed Data	LSD	32	
Status Symbols (6)	SS	12	See Table 2.2.7.3.1.3-2

Table 2.2.7.3.1.3-1 P25 Voice Frame Fields

Note: Although encryption is not supported, Header Word fields and the Link Control Format (LCF) will be displayed correctly because they are not subject to encryption. Therefore, if these fields indicate encryption, other fields will not be displayed correctly. Fields that are subject to encryption include the vocoder information and Link Control information content.

Value (binary)	Note	Transmitter
00	Unknown, use for talk-around	subscriber
01	Inbound Channel is Busy	base station/repeater
10	Unknown, use for inbound or outbound	subscriber
11	Inbound Channel is Idle	base station/repeater

Table 2.2.7.3.1.3-2 P25 Status Symbol Codes

Note: Status symbols are combined by concatenating their binary values but are displayed in hexadecimal. For example, an idle channel that just became busy is displayed as D5 (11010101).

Value	DUID	Note
0	HEADER	Header Data Unit
3	TERM	Terminator without LC
5	LDU1	Logical Link Data Unit 1
7	TSBK	Trunking Signaling Data Unit (block)
10 (and 5)	LDU1:LDU2	Logical Link Data Unit 2 (and 1)
12	PDU	Packet Data Unit
14	TERM(LC)	Terminator with LC
-	-	Reserved

Table 2.2.7.3.1.3-3 P25 Data Unit Identifier Values

Note: The DUID field is LDU1 if the frame contained just the first Logical Link Control Unit before the terminator. It is LDU1:LDU2 if the frame contains both the first and second before the terminator; they are combined to display the complete information together.

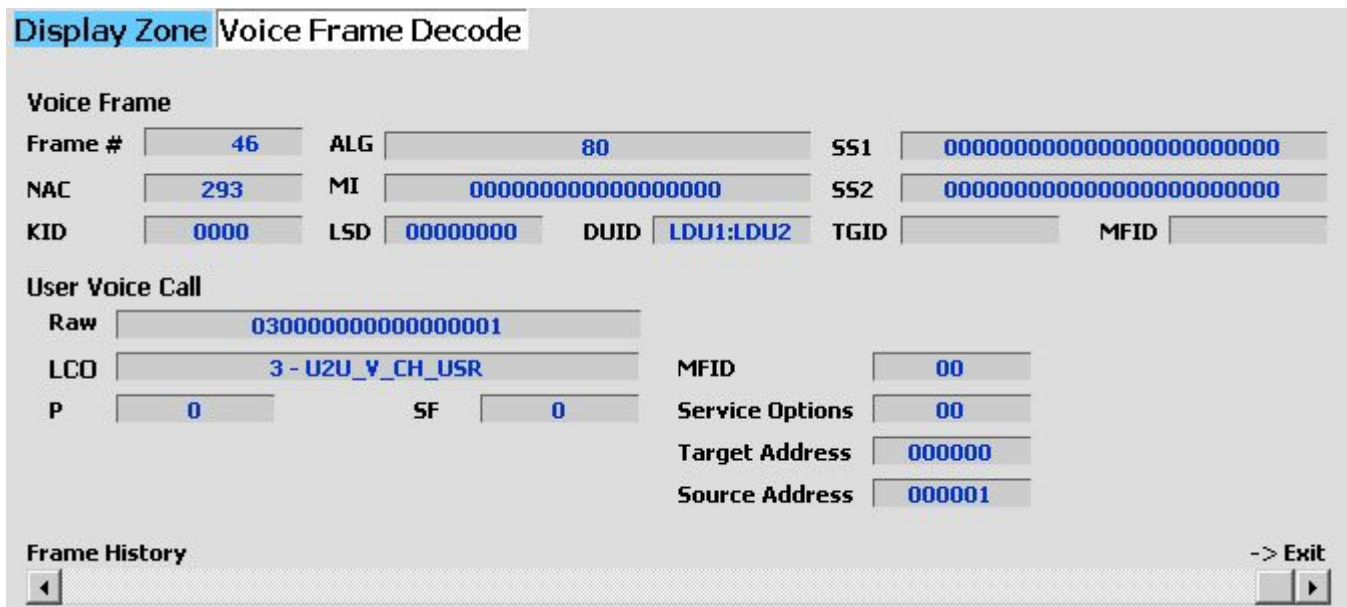

Figure 2.2.7.3.1.3-4 P25 Voice Frame Decode Unit to Unit

The User Voice Call fields are from the Link Control code word. Raw displays all nine bytes directly; subsequent fields display the same information in individual fields according to the Link Control opcode (LCO), if applicable. The “0 - GRP_V_CH_USR” (Group Voice Channel User) message indicates the user of this channel for group voice traffic on both inbound and outbound messages (see Figure 2.2.7.3.1.3-3 for field details). The “3 - LC_U2U_V_CH_USR” (Unit to Unit Voice Channel User) message indicates the user of this channel for unit to unit voice traffic, on both inbound and outbound messages and on conventional and trunked systems. (See Figure 2.2.7.3.1.3-4 for field details.)

Name	Mnemonic	Bits	Value (hex)	Note
Emergency	E	1	80	
Protected	P	1	40	Encryption is not supported
Duplex	D	1	20	
Mode	M	1	10	
Reserved	R	1	08	0 is specified
Priority Level		3	01 to 07	Highest to lowest

Table 2.2.7.3.1.3-4 P25 Service Options

Note: Service options are combined by adding their respective values. Example: The Emergency, Duplex, and Highest Priority Level options combined have a value of A1.

Constellation Plot (Display Zone selection)

This selection displays the EVM measurement and a graph showing the symbol constellation on the complex I/Q plane. The display provides a visual representation of overall transmitter operation (see Figure 2.2.7.3.1.3-5), when Monitor Modulation Type is complex, e.g. LSM or WCQPSK. The measurement is done at the optimal symbol times and positions to exclude adverse effects of frequency error and residual carrier. The Display Mode setting configures the amount of information on the graph.

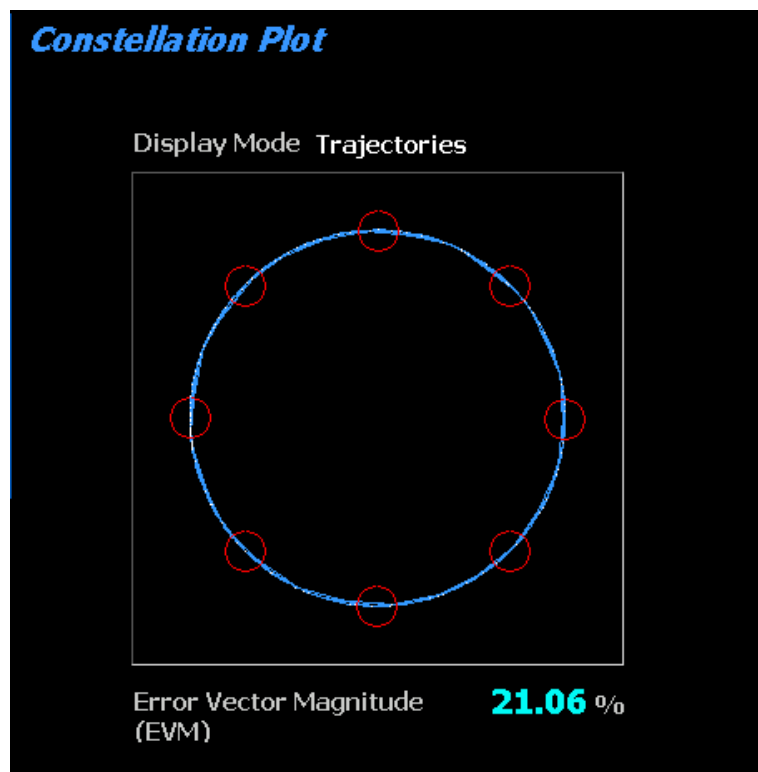

Figure 2.2.7.3.1.3-5 Constellation Plot (Symbols)

Error Vector Magnitude (Constellation Plot display)

EVM (RMS) provides a quantitative representation of the overall transmitter operation to the constellation diagram (see Figure 2.2.7.3.1.3-5).

Constellation Graph (Constellation Plot display)

P25 LSM/WCQPSK radios broadcast voice and data using eight differential phase shift deviations from the carrier to represent symbols containing three data bits. One of eight phase shifts relative to the carrier's current phase yields eight phase points. The phase trajectory never passes through the origin, ensuring that signal amplitude never falls to zero during data transmissions (see Figure 2.2.7.3.1.3-6). The center of the eight red circles on the display represent the expected locations for the deviation states when the radio is transmitting data bit symbols using the modulation. White dots show the actual deviation measurement at symbol decision times. A tighter grouping within the red circles indicates more accurate transmitter performance. The radius of the circles is the 10% EVM (Peak) limit.

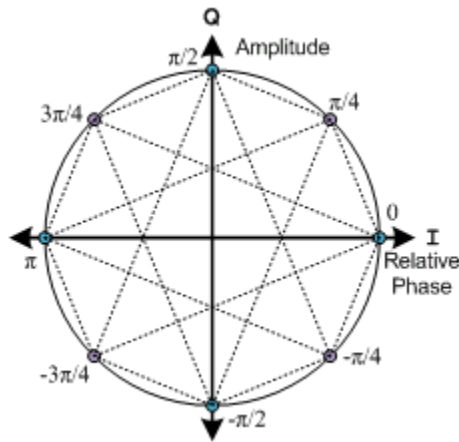

Figure 2.2.7.3.1.3-6 Ideal Constellation

Constellation Display Mode (Constellation Plot submenu)

This mode selects the display presentation with the following horizontal menu choices:

Symbols – This choice displays only the samples at the optimal symbol decision times, displayed as white dots. Correct transmitter operation should group them tightly around the eight ideal phase points (see Figure 2.2.7.3.1.3-6).

Samples – In addition to the symbol points, samples between symbol times three times their number are displayed as blue dots (see Figure 2.2.7.3.1.3-7).

Trajectories – Instead of sample points, blue lines connect adjacent samples to approximate the continuous transmitter output throughout the burst (see Figure 2.2.7.3.1.3-7).

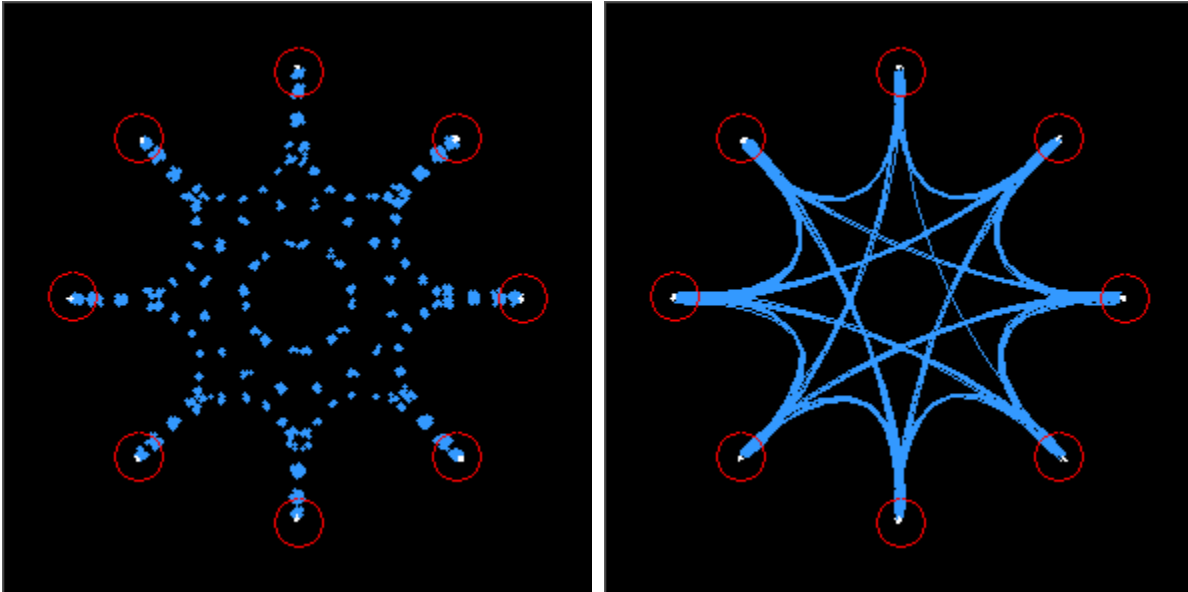

Figure 2.2.7.3.1.3-7 Constellation Plot (Samples / Trajectories)

Distribution Plot (Display Zone selection)

This selection displays a graph showing the distribution of symbol deviations of the received signal grouped into frequency bins of 10 Hz or less (i.e. the frequency offset versus the rate of occurrence of that frequency). Each plot consists of at least a second of the most current data available. The protocol consists of four symbol values (-3, -1, +1, +3) at proportional carrier deviations (see Table 2.2.7.3.1.2-1). The four ideal symbol deviations are labeled at gridlines. Additional gridlines half way between labels divide the plot into four equal regions and mark the thresholds where symbol decisions change from one to the other. For example, in low power conditions, noise may cause a symbol's deviation to appear in the adjacent region, thus causing a bit error.

All distribution amounts are displayed by automatic adjustment of the vertical axis scaling to show the full amount of symbols falling into each bin. Distribution amounts are the percentage of the number of symbols whose deviation falls within that point's frequency bin based on the number of symbols in the analysis population. The better a signal is, the more symbols will actually land in the ideal bin to increase its percentage. Deviations that are past the graph edge limits (e.g. for noise if no signal exists) are collected and shown in the bin at the limit.

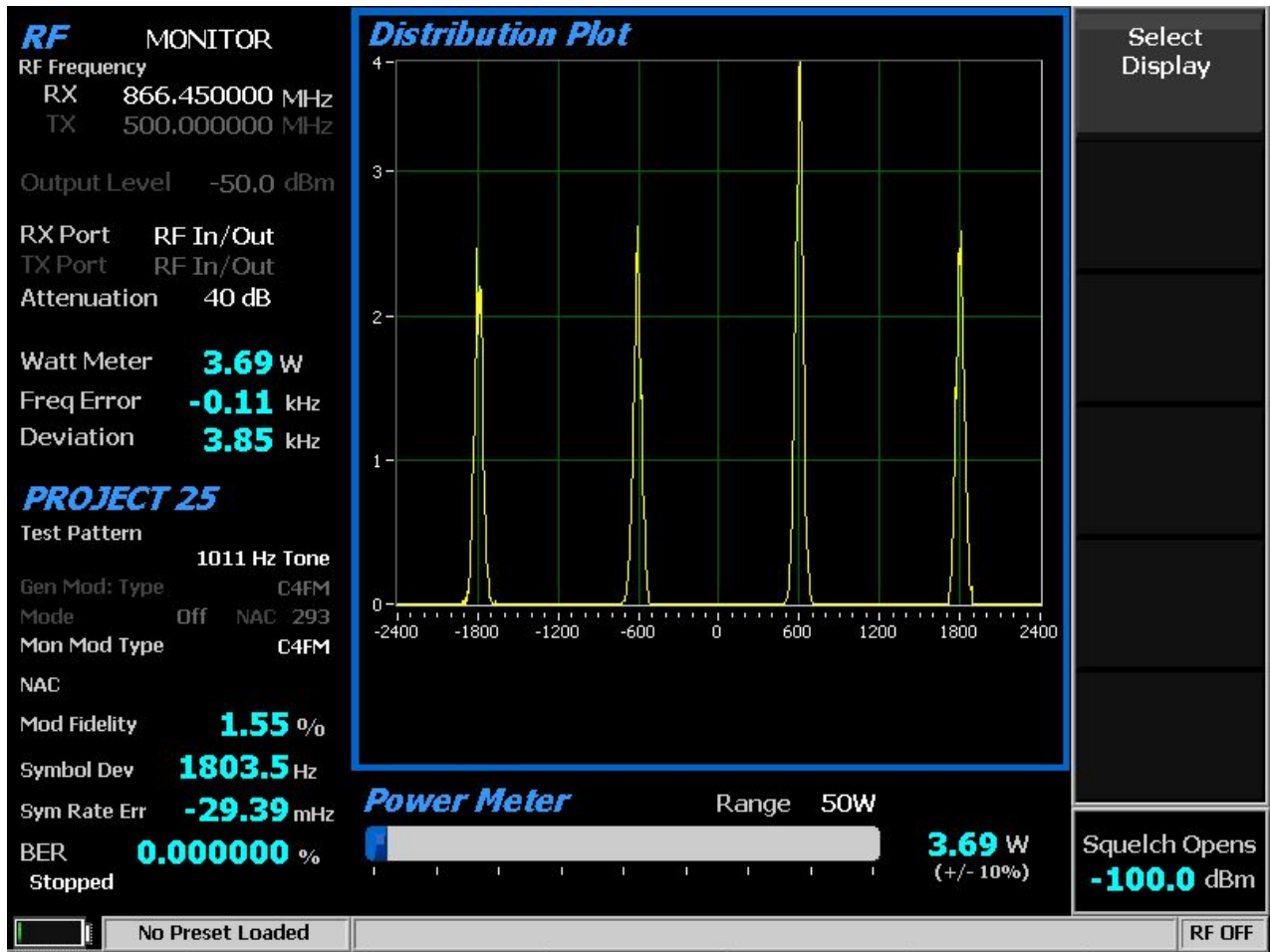

Figure 2.2.7.3.1.3-8 Distribution Plot of 1011 Hz Tone

2.2.7.3.1.4 Meter Zone

See 2.2.5 Meter Zone for standard selections.

2.2.7.3.2 P25 receiver tests

P25 receiver tests are performed with the R8100 in Generate or Duplex Mode, and protocol-specific tests are accessed with the PROJECT 25 soft key (see Figure 3.2.8.4.2-1). The R8100 can generate various P25 compliant test patterns using C4FM modulation (see Figures 3.2.8.4.2-2). Test patterns that yield an audio tone can be heard in the receiver of the radio under test. Others can be used in conjunction with the radio manufacturers' RSS to perform BER testing and alignment. A means is provided to change the Network Access Code (NAC) and edit the P25 Voice Frame to adapt to the system under test.

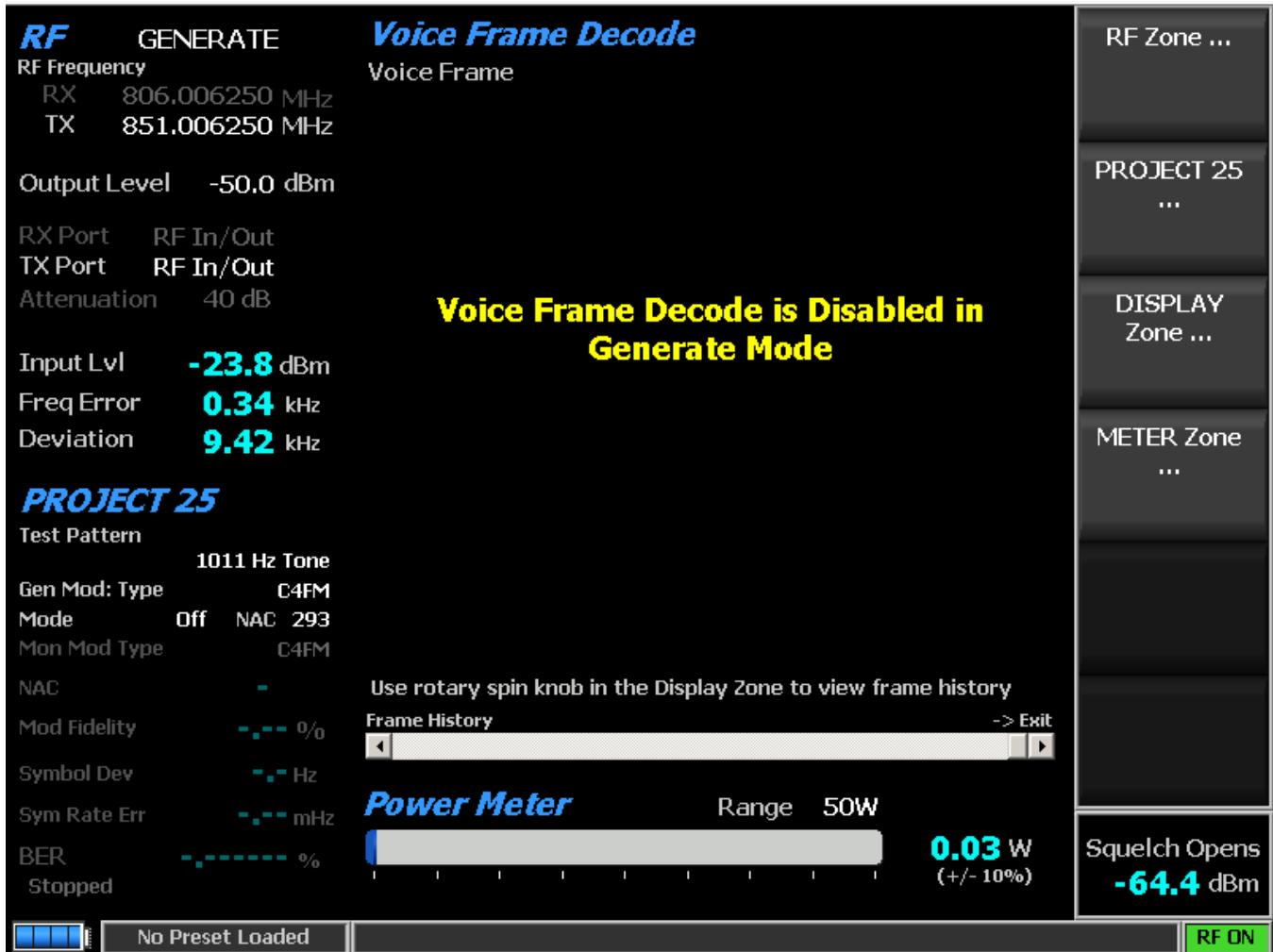

Figure 3.2.8.4.2-1 Main screen in Generate Mode after pressing the PROJECT 25 soft key

Test Pattern (P25 submenu)

This field provides selection for one of seven TIA/EIA-102.CAAA compliant predefined bit patterns for BER testing of a P25 radio in Receive Mode. To receive framed test patterns generated from the R8100, the radio under test must be programmed to the same Network Access Code (NAC). 293 is the default in the R8100; this will break the radio's selective squelch so the tone or pattern can be reproduced in the audio circuits. The following patterns are available:

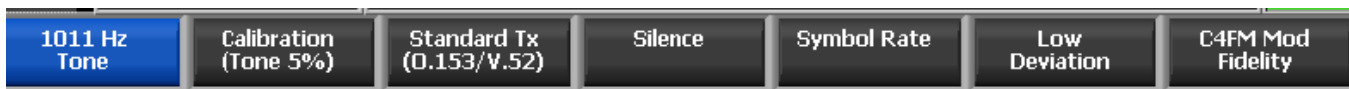

Figure 3.2.8.4.2-2 P25 Generate Mode test patterns

1011 Hz Tone pattern selects the standard tone framed test pattern of the 1011 Hz vocoder tone.

Calibration (Tone 5%) test pattern is derived from the standard 1011 Hz Tone test pattern used to verify BER measurements are operating correctly. Every 20th bit is inverted to yield 172 errors out of 3456 bits resulting in a 4.976852% BER.

Standard Tx (O.153/V.52) is the standard transmitter test pattern of continuously repeating 511-bit pseudo random number sequences based on ITU-T O.153 (formerly CCITT V.52).

Silence key displays the framed test pattern for silence at the vocoder.

Symbol Rate key displays the maximum frequency deviation test pattern of a continuously repeating stream of high deviation symbols (+3, +3, -3, -3, ...).

Low Deviation key displays the test pattern of a continuously repeating stream of low deviation symbols (+1, +1, -1, -1, ...) for a 1/3 maximum frequency deviation.

C4FM Mod Fidelity key displays the test pattern of a continuously repeating 24 bit sequence (12 symbols) used for measuring C4FM modulation fidelity (+3, +3, -3, +1, +1, +3, -1, +3, -3, -1, -3, -3).

Two additional TIA/EIA-102.CAAA compliant bit patterns can easily be created for testing a P25 radio in Receive Mode by using the procedure below:

1. Set Test Pattern to 1011 Hz Tone.
2. Set Voice Frame Encoder, Status Symbols as specified below.

Note: *For compliance, the NAC and other voice frame fields should be defaults.*

Busy – This test pattern provides channel busy information.

Idle – This test pattern provides channel idle information. Beware that one bit (2374) of this pattern will differ from TIA/EIA-102.CAAA (1.3.3.6 e) Standard Idle Test Pattern.

Note: *These test patterns allow subscriber alignment for Automatic Frequency Control.*

Generate Modulation Type (P25 submenu)

This key selects the desired type of modulation for the generated signal required by the receiver: C4FM, LSM, or WCQPSK.

Modulation Mode (P25 submenu)

This key provides a horizontal submenu providing choice of Off, Continuous, or Burst Mode for the selected Test Pattern modulation. **Note:** *Enabling a test pattern in Generate Mode will erase any previously captured Voice Recordings.*

NAC (P25 submenu)

This key sets the Network Access Code (NAC) to match the radio or system under test in a data entry window. The range of values is from hexadecimal 000 to FFF. Alphanumeric entries are made using the ▲▼ (Up/Down) and ◀▶ (Left/Right) keys, numeric keypad, and spin knob. In Generate Mode, the NAC soft key is hidden, and its display value is grayed out for unmodifiable test pattern selections (e.g. Calibration).

Voice Frame Encoder (P25 submenu)

This key accesses a P25 Voice Frame Encoder to allow editing of embedded signaling information contained in the R8100 P25 voice frames. This allows the R8100 Voice Frame configuration to match the radio or system under test see Figure 3.2.8.4.2-3). In Generate Mode, the Voice Frame Encoder soft key is hidden for unmodifiable test pattern selections (e.g. Calibration).

Voice Frame Encoder submenu selections are as follows:

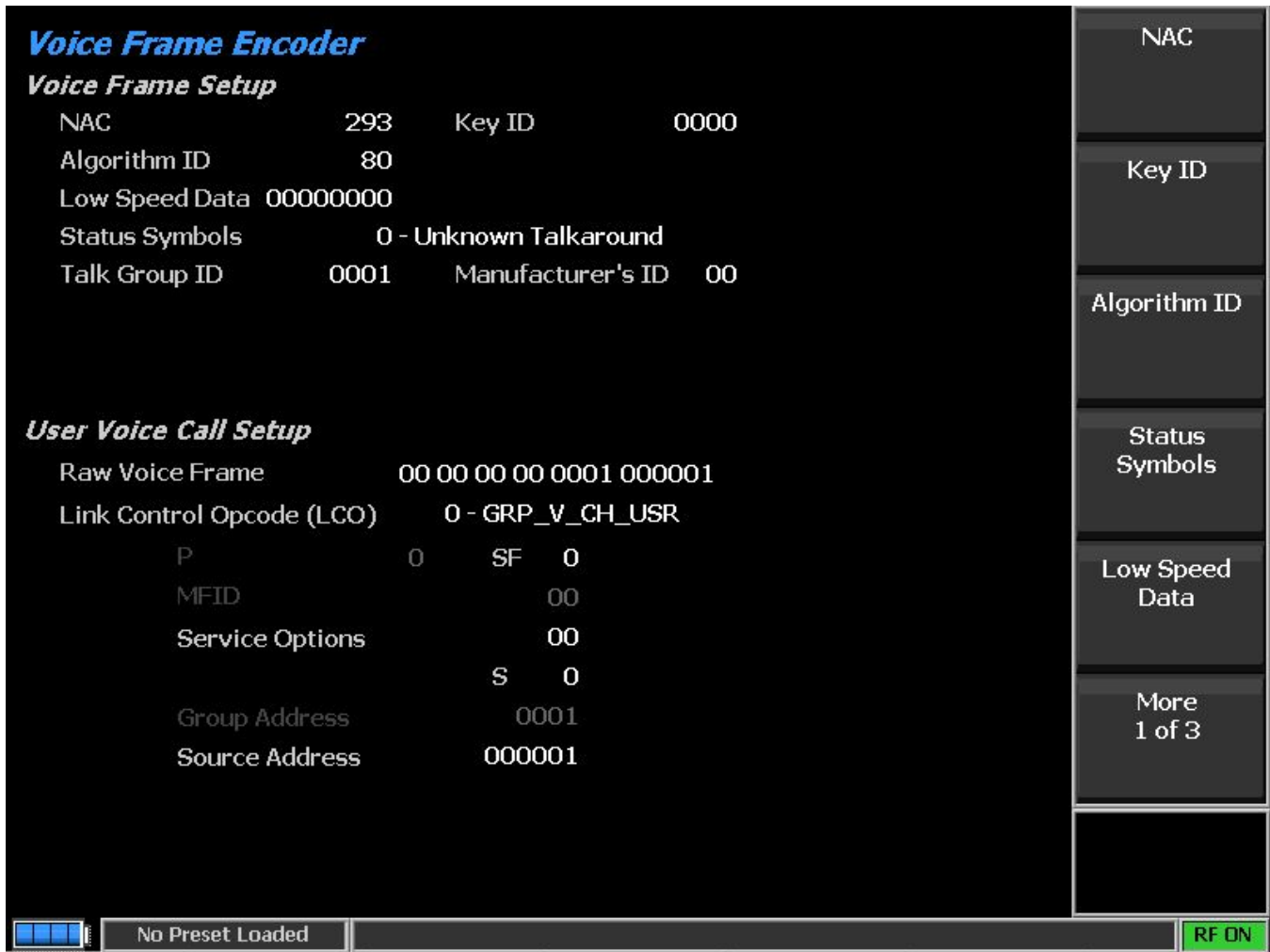

Figure 3.2.8.4.2-3 P25 Voice Frame Encoder submenu

NAC (Voice Frame Encoder submenu)

This key sets the Network Access Code (NAC) to match the radio or system under test within the Voice Frame submenu in a data entry window. (This NAC is the same as that in the P25 zone submenu.) The range of values is from hexadecimal 000 to FFF. Alphanumeric entries are made using the ▲▼ (Up/Down) and ◀▶ (Left/Right) keys, numeric keypad, and spin knob.

Key ID (Voice Frame Encoder submenu)

When encryption is used, this key identifies the specific encryption key used when multiple keys are present on the encryption modules. The range of values is from hexadecimal 0000 to FFFF. Alphanumeric entries are made using the ▲▼ (Up/Down) and ◀▶ (Left/Right) keys, numeric keypad, and spin knob.

Algorithm ID (Voice Frame Encoder submenu)

When encryption is used, this key identifies the specific encryption algorithm used in the system. Hexadecimal 80 is the default value, indicating no encryption algorithm is used. The range of values is from hexadecimal 00 to FF. Alphanumeric entries are made using the ▲▼ (Up/Down) and ◀▶ (Left/Right) keys, numeric keypad, and spin knob.

Status Symbols (Voice Frame Encoder submenu)

This key displays a horizontal menu that provides selections for indicating the status of the inbound channel when the R8100 emulates a P25 repeater.

- 0 – Unknown Talkaround
- 1 – Busy
- 2 – Unknown In/Out
- 3 – Idle

Low Speed Data (Voice Frame Encoder submenu)

This selection allows the entering of custom user data not defined by the Common Air Interface (CAI). The range of values is from hexadecimal 00000000 to FFFFFFFF. Alphanumeric entries are made using the ▲▼ (Up/Down) and ◀▶ (Left/Right) keys, numeric keypad, and spin knob.

Talk Group ID (Voice Frame Encoder submenu)

This selection allows the entering of the Talk Group ID (TGID). Otherwise, a standard value of hexadecimal 0001 is used. The range of values is from hexadecimal 0000 to FFFF. Alphanumeric entries are made using the ▲▼ (Up/Down) and ◀▶ (Left/Right) keys, numeric keypad, and spin knob. The value entered is used for the header word as well as the Link Control word (if applicable).

MFID (Voice Frame Encoder submenu)

Enter Manufacturer ID from assigned list. It is used when non-standard data or manufacturer proprietary signaling is embedded in the voice frame. Otherwise, a standard value of hexadecimal 00 is used, indicating all information fields conform to the CAI. The range of values is from hexadecimal 00 to FF. Alphanumeric entries are made using the ▲▼ (Up/Down) and ◀▶ (Left/Right) keys, numeric keypad, and spin knob. The value entered is used for the header word as well as the Link Control word (if applicable). **Note:** *The value entered is transmitted even if the Implicit MFID bit is set (SF=1); it is the receiver's responsibility to ignore it.*

Field	Mnemonic	Bits	Note
Network Identifier	NID	16	
Network Access Code	NAC	12	293=Default
Data Unit ID	DUID	4	0=Header Data Unit
Header Word		120	
Message Indicator	MI	72	Encryption is not supported
Manufacturer's ID	MFID	8	Also copied to Link Control
Algorithm ID	ALGID	8	Encryption is not supported
Key ID	KID	16	Encryption is not supported
Talk-group ID	TGID	16	Also copied to Link Control
Link Control	LC	72	Format varies
Low Speed Data	LSD	32	
Status Symbols (6)	SS	12	2 bits after every 70 bits

Table 2.2.7.3.1.4-1 P25 Voice Frame Fields

Link Control Opcode (Voice Frame Encoder submenu)

This selection defines the content embedded in the user voice call by specifying the set of editable information fields in the P25 Link Control Word. Select in a list entry window using the Up/Down (▲▼) keys or spin knob.

Raw allows the information fields to be entered directly as 18 hex digits. Alphanumeric entries are made using the ▲▼ (Up/Down) and ◀▶ (Left/Right) keys, numeric keypad, and spin knob.

0 - GRP_V_CH_USR (Group Voice Channel User) message, which indicates the user of this channel for group voice traffic, has the following fields: SF (MFID Format), Service Options, S (Explicit Source ID), Source Address (SID). **Note:** *Manufacturer's ID and Group Address are specified in the Voice Frame Setup above, MFID and Talk Group ID respectively.*

Field	Mnemonic	Bits	Note
Format	LCF	8	
Protected flag	P	1	Encryption is not supported
Standard Format	SF	1	0=specification
Opcode	LCO	6	0=specification
Manufacturer's ID	MFID	8	Same as Header Word's MFID
Service Options		8	
Emergency	E	1	MSB
Protected	P	1	Encryption is not supported
Duplex	D	1	
Mode	M	1	
Reserved	R	1	
Priority Level		3	0 to 7 (lowest)
Reserved		8	
Group Address		16	Same as Header Word's TGID
Source Address		24	Also Source ID (SID)

Table 2.2.7.3.1.4-2 P25 Link Control Fields for LCO=1

3 – LC_U2U_V_CH_USR (Unit to Unit Voice Channel User) message, which indicates the user of this channel for unit to unit voice traffic, has the following fields: SF (MFID Format), Service Options, Target Address (DID), Source Address (SID). **Note:** *Manufacturer's ID (MFID) is specified in the Voice Frame Setup above.*

Field	Mnemonic	Bits	Note
Format	LCF	8	
Protected flag	P	1	Encryption is not supported
Standard Format	SF	1	0=specification
Opcode	LCO	6	3=specification
Manufacturer's ID	MFID	8	Same as Header Word
Service Options		8	
Emergency	E	1	Hex 80; MSB
Protected	P	1	Hex 40; Encryption is not supported
Duplex	D	1	Hex 20
Mode	M	1	Hex 10
Reserved	R	1	
Priority Level		3	00 to 07; highest to lowest
Target Address		24	Also Destination ID (DID)
Source Address		24	Also Source ID (SID)

Table 2.2.7.3.1.4-3 P25 Link Control Fields for LCO=3

SF – MFID Format (Voice Frame Encoder submenu)

Set Implicit or Explicit Mode for the MFID in the opcode. When set to “1 – Standard MFID,” the standard Manufacturers ID (00) is implied as being used. When set to “0 – Explicit Format,” the Manufacturer’s ID is part of the opcode. Select in a list entry window using the Up/Down (▲ ▼) keys or spin knob.

Service Options (Voice Frame Encoder submenu)

This field sets the type of services in use by the subscriber unit. The range of values is from hexadecimal 00 to FF. Alphanumeric entries are made using the ▲ ▼ (Up/Down) and ◀ ▶ (Left/Right) keys, numeric keypad, and spin knob. The entry is the hexadecimal sum of the values chosen from the table below (E P D M R P-L):

E – Emergency

00 = Normal

80 = Emergency status requiring special processing

P – Protected (encrypted)

00 = Non-protected mode

40 = Protected mode

D – Duplex

00 = Half-duplex: the subscriber unit is capable of transmitting but not simultaneously receiving on the assigned channel.

20 = Full duplex: the subscriber unit is capable of transmitting and receiving simultaneously on the assigned channel.

M – Mode: data mode of service

00 = Circuit mode: the resources shall support circuit switch operation.

10 = Packet mode: the resources shall support packet switch operation.

R – Reserved

0 = Set by the sender and ignored by the receiver

P-L – Priority Level

0 – 7 = The relative importance attribute to the service that is being requested

S – Explicit Source ID (Voice Frame Encoder submenu)

This selection sets Explicit Mode for the Source Address in the opcode. When set to “0- Not Required,” the Source ID address is sufficient to completely represent the requesting unit on the current P25 system. When set to “1 – Required,” the next Link Control message will have a Source ID extension carrying the complete SUID of the requesting unit. Select in a list entry window using the Up/Down (▲ ▼) keys or spin knob.

Source Address (Voice Frame Encoder submenu)

Enter the Source ID address of the requesting unit. The range of values is from hexadecimal 000000 to FFFFFFFF. Alphanumeric entries are made using the ▲ ▼ (Up/Down) and ◀ ▶ (Left/Right) keys, numeric keypad, and spin knob.

Reset to Defaults (Voice Frame Encoder submenu)

This selection resets all Voice Frame data fields to factory defaults.

2.2.7.4 PROJECT 25 Test Mode (Trunking)

The optional R8100 P25 Trunk Test Mode allows testing of trunked APCO Project 25 (P25) compliant radios. P25 mobile stations (radios) use a digital transmission format employing Continuous 4 level FM (C4FM) modulation. The R8100 P25 Trunk Mode simulates the functions of a Project 25 central controller with the control and voice channel protocols needed for various tests. The simulation can be configured to generate C4FM as well as LSM (Linear Simulcast Modulation) and WCQPSK (wide Continuous Quadrature Phase Shift Keying). Also included are TIA/EIA-102.CAAA compliant test patterns for Bit Error Rate (BER) testing, Frequency Error and Power meters, an Eye Diagram with graphical representation of the P25 signal, and modulation signal quality meters.

A Voice Loop feature (U.S. patent 5703479) is engaged for audio verification of the radio's end-to-end operation after the subscriber unit transmits. During a Voice Call, the R8100 automatically records voice channel data while the subscriber unit PTT is pressed then retransmits it to provide audio verification of the radio's end-to-end operation.

The manufacturer's Radio Service Software (RSS) is required to perform some tests in P25 Trunk Mode because certain measurements (BER) require placing the radio in a special test mode. Figure 3.2.8.5-1 shows the R8100 main screen after choosing the P25 Trunk Test Mode.

As usual, the RF Zone can be used to configure various settings such as output level, attenuation, and ports, etc. However, the soft keys for Monitor and Generate frequencies are disabled. These frequencies are determined by settings in the P25 Trunk Zone, either the control/voice channel frequency settings or the control/voice channel number settings, according to the Band Plan Table.

Note: *RF Zone Monitor and Generate frequency settings can be changed for the BER Test. Otherwise, they are read-only and updated in real-time to show the control channel frequencies or the voice channel frequencies that are in use.*

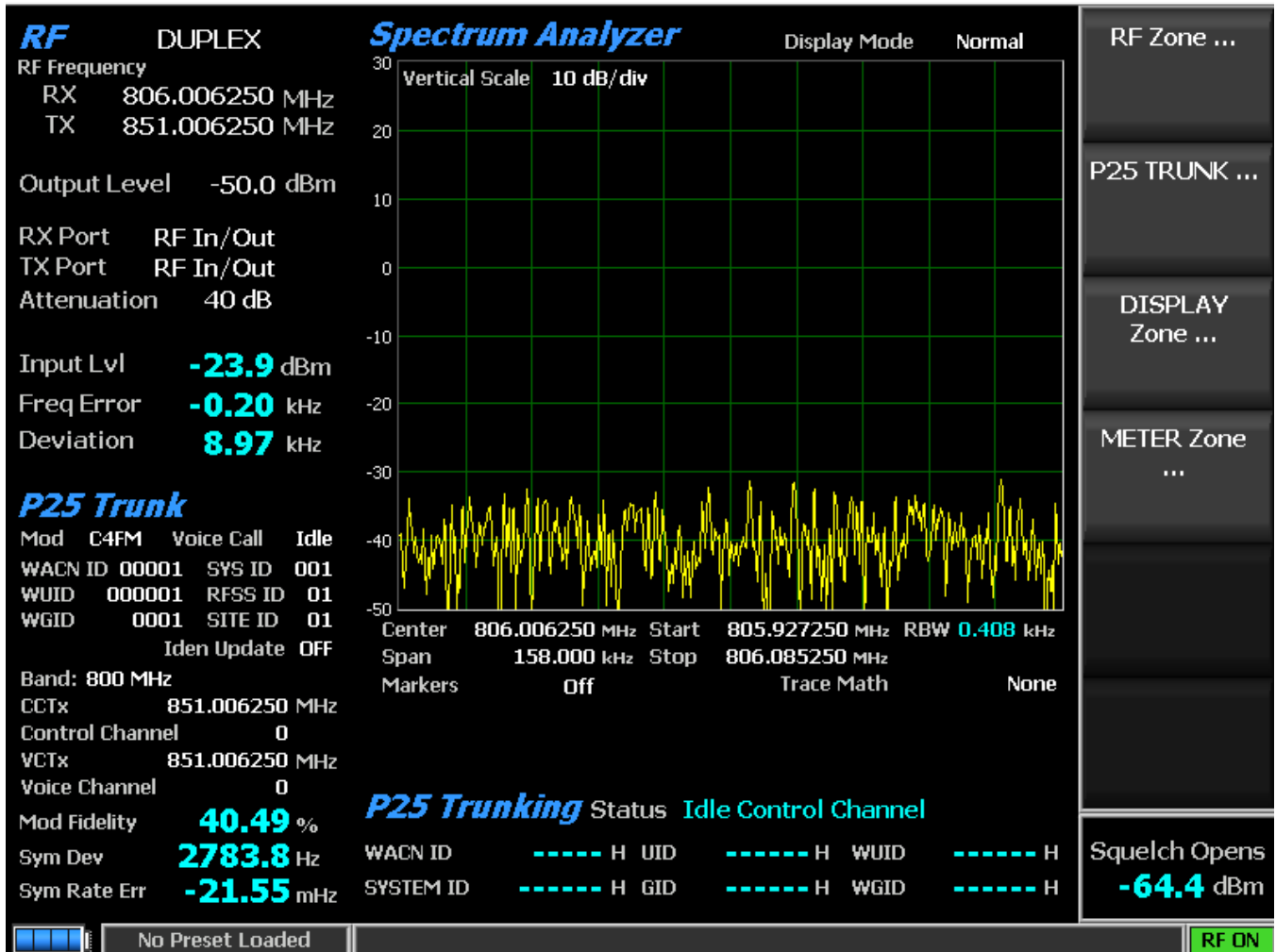

Figure 3.2.8.5-1 Main screen after selecting P25 Trunk Test Mode

When the P25 Trunk Test Mode is selected, the R8100 is automatically placed in Duplex Mode and begins transmitting idle messages on the control channel with no encryption. Pressing the P25 Trunk soft key on the main screen displays a submenu with the following settings (see Figure 3.2.8.5-2).

A P25 trunked radio connected to the R8100 and turned on automatically registers with the analyzer if the Band Plan settings are configured for the system under test. The registration progress is shown in the Meter Zone “Status” field, and the radio ID parameters are populated on the display.

Once the radio is registered (see Figure 3.2.8.5-3 Meter Zone), a voice test using the Voice Loop feature can be performed. Keying the radio under test transitions it to the voice channel, and the R8100 automatically records up to the last 10 seconds of conversation, as long as the signal is above the squelch level setting. Unlike other test modes, the Voice Loop feature is always enabled in P25 Trunk Test Mode. The maximum length of a recording is fixed at 10 seconds. The recording continues if the transmission is longer than this duration, but only the most recent is retained. Modulation Fidelity, Symbol Deviation, and Symbol Rate Error measurements are available for the transmission signal being recorded; for explanations see Section 2.2.7.3 for the PROJECT 25 Test Mode (Conventional). When the radio is unkeyed, the R8100 initiates a voice call and replays the last recorded conversation; to play another conversation, another recording must be made. This provides a quick end-to-end test of the P25 radio

transmitter and receiver. This Voice Loop feature can even be used to verify basic functionality of a P25 radio with an encrypted voice channel.

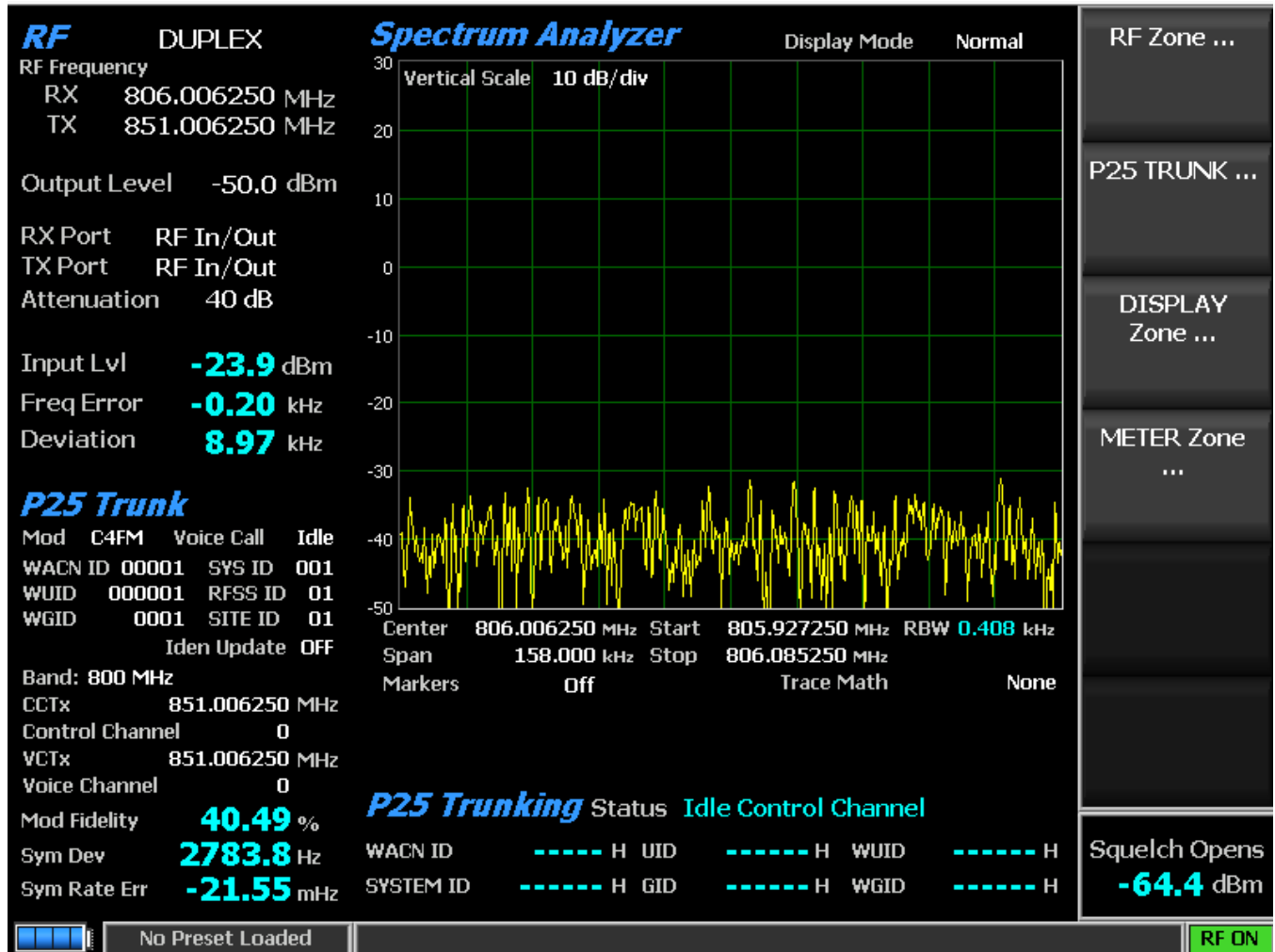

Figure 3.2.8.5-2 Main screen after pressing P25 Trunk soft key

Generate Modulation Type (P25 Trunk submenu)

This key selects the desired type of modulation (C4FM, LSM, or WCQPSK) for the generated signal required by the receiver.

Voice Call (P25 Trunk submenu)

Select Start and Stop for the Voice Call test. The R8100 sends out a control channel message causing the subscriber radio to transition to a voice channel. The analyzer transmits a 1011 Hz tone that should be heard on the radio to confirm this transition.

Send Call Alert (P25 Trunk submenu)

This key initiates a call alert to the subscriber radio under test to verify it is capable of registering and receiving a call alert from a P25 base station. Messages in Meter Zone “Status” field show the activity during a Call Alert.

WACN ID (P25 Trunk submenu)

This key sets the Wide Area Communication Network IDentity (WACN ID) of the P25 system being tested. The range of values is from hexadecimal 00000 to FFFFF. Alphanumeric entries are made using the ▲▼ (Up/Down) and ◀▶ (Left/Right) keys, numeric keypad, and spin knob.

SYSTEM ID (P25 Trunk submenu)

This key sets the System IDentity within the WACN of the P25 system being tested. The range of values is from hexadecimal 000 to FFF. Alphanumeric entries are made using the ▲▼ (Up/Down) and ◀▶ (Left/Right) keys, numeric keypad, and spin knob.

WUID (P25 Trunk submenu)

This selection sets the Working Unit IDentity (e.g. ID in the system). The range of values is from hexadecimal 000000 to FFFFFFF. Alphanumeric entries are made using the ▲▼ (Up/Down) and ◀▶ (Left/Right) keys, numeric keypad, and spin knob.

RFSS ID

This selection sets the RF Subsystem ID of the core infrastructure providing P25 service within the Wide Area Communication Network. The range of values is from hexadecimal 00 to FF. Alphanumeric entries are made using the ▲▼ (Up/Down) and ◀▶ (Left/Right) keys, numeric keypad, and spin knob.

WGID

This key sets the Working Group IDentity (e.g. talkgroup of the channel). The range of values is from hexadecimal 0000 to FFFF. Alphanumeric entries are made using the ▲▼ (Up/Down) and ◀▶ (Left/Right) keys, numeric keypad, and spin knob.

SITE ID

This key sets the identity of the site within the RF Subsystem. The range of values is from hexadecimal 00 to FF. Alphanumeric entries are made using the ▲▼ (Up/Down) and ◀▶ (Left/Right) keys, numeric keypad, and spin knob.

Band Plan Table

This key activates a submenu with a table that defines the channel characteristics for the P25 frequency band from the perspective of the radio. All of the fields are used to create the Identifier Update (IDEN_UP/IDEN_UP_VU) TSBK for transmit to the radio; some are used by the R8100 to emulate the base station. The default plan can be customized with soft keys as described below (see Figure 3.2.8.5-4).

Note: *If necessary, use RSS to read system values from the radio.*



Figure 3.2.8.5-4 P25 Trunk Band Plan submenu

Band (Band Plan Table submenu)

This key selects 800 MHz, 700 MHz, or UHF/VHF using a horizontal submenu. This is used to determine the Identifier Update TSBK format and the band plan defaults.

Set Band Plan to defaults (Band Plan Table submenu)

This key sets Base Frequency, Channel Spacing, TX Offset, and Channel Identifier values to system defaults according to the specified Band setting.

Band	Base Frequency (MHz)	Last Frequency (MHz)	Channel Spacing (kHz)	Transmit Offset (MHz)	Channel Identifier
800 MHz	851.006250	876.600000	6.250	-45	1
700 MHz	762.006250	787.600000	6.250	+30	2
UHF/VHF	450.000000	475.593750	6.250	-45	3

Table 3.2.8.5-1 P25 Trunk Band Plan Defaults

Bandwidth (Band Plan Table submenu)

This key selects 6.25 kHz or 12.5 kHz using a horizontal submenu.

Base Frequency (Band Plan Table submenu)

This key sets the radio's receive frequency for channel number 0 in MHz using the ▲▼ (Up/Down) and ◀▶ (Left/Right) keys, numeric keypad, and spin knob.

Channel Spacing (Band Plan Table submenu)

This key sets the frequency distance between adjacent channels in 0.125 kHz increments using the ▲▼ (Up/Down) and ◀▶ (Left/Right) keys, numeric keypad, and spin knob. This is used to compute the channel frequency from the channel number (or vice versa).

Transmit Offset (Band Plan Table submenu)

This key sets the frequency offset from the radio receive frequency to the radio transmit frequency in MHz using the ▲▼ (Up/Down) and ◀▶ (Left/Right) keys, numeric keypad, and spin knob. Conversely, the setting defines the offset from the base station transmit frequency to the base station receive frequency.

Radio TX frequency = Radio RX frequency + Transmit Offset

Base Station TX frequency = Base Station RX frequency - Transmit Offset

Channel Identifier (Band Plan Table submenu)

This key sets the channel plan number from one to 16 using the ▲▼ (Up/Down) and ◀▶ (Left/Right) keys, numeric keypad, and spin knob. This value is used as part of the channel definition in the voice channel grant message.

Identifier Update (P25 Trunk submenu)

This key selects ON or OFF. Activate the Identifier Update that provides data to inform the subscriber unit of the parameters associated with a specific channel. When set to ON, the IDEN_UP TSBK appropriate for the specified Band Plan (see Band Plan Table submenu) is transmitted on the control channel. The 700 MHz and 800 MHz bands use the 800/700 MHz format IDEN_UP TSBK with fields set as specified in the Band Plan Table; the UHF/VHF bands use the UHF/VHF MHz format IDEN_UP_VU TSBK. When OFF, no IDEN_UP TSBK is transmitted on the control channel.

Control Chnl TX Frequency (P25 Trunk submenu)

This selection sets the base station control channel generate frequency directly in MHz using the ▲▼ (Up/Down) and ◀▶ (Left/Right) keys, numeric keypad, and spin knob. The Control Chnl field displays the closest corresponding Control Channel number as determined by the Band Plan Table, which may result in a negative channel number if the specified frequency is less than the Band Plan Table's Base Frequency. **Note:** *The CCTx setting is updated accordingly or can be used to enter the channel number instead.*

Control Chnl TX Frequency = Radio Control Channel TX Frequency - Transmit Offset

CCTx Channel (P25 Trunk submenu)

This selection sets the Control Channel number from 0 to 4095 using the ▲▼ (Up/Down) and ◀▶ (Left/Right) keys, numeric keypad, and spin knob. The CCTx field displays the corresponding base station Control Channel Generate Frequency as determined by the Band Plan Table. **Note:** *The Control Chnl TX Frequency setting is updated accordingly or can be used to enter the frequency directly.*

Radio Generate Frequency = Base Frequency + Transmit Offset + Channel Spacing * CCTx Channel #

Voice Chnl TX Frequency (P25 Trunk submenu)

Set the base station voice channel generate frequency directly in MHz using the ▲▼ (Up/Down) and ◀▶ (Left/Right) keys, numeric keypad, and spin knob. The Voice Chnl field displays the closest corresponding Voice Channel number as determined by the Band Plan Table, which may result in a negative channel number if the specified frequency is less than the Band Plan Table's Base Frequency. **Note:** *The VCTx setting is updated accordingly or can be used to enter the channel number instead.*

Voice Chnl TX Frequency = Radio Voice Channel TX Frequency - Transmit Offset

VCTx Channe (P25 Trunk submenu)

This selection sets the Voice Channel number from 0 to 4095 using the ▲▼ (Up/Down) and ◀▶ (Left/Right) keys, numeric keypad, and spin knob. The VCTx field displays the corresponding base station Voice Channel Generate Frequency as determined by the Band Plan Table. **Note:** *The Voice Chnl TX Frequency setting is updated accordingly or can be used to enter the frequency directly.*

Radio Generate Frequency = Base Frequency + Transmit Offset + Channel Spacing * VCTx Channel #

BER Test (P25 Trunk submenu)

This key selects Stop and Start for the BER test. Pressing Start displays a new P25 Trunk BER screen and submenu; Stop ends the testing and restores the default screen/submenu. When running, trunking operation ceases, and BER specific setting and display fields are available. Modulation Type, Modulation Mode, and Test Pattern settings are provided for testing receivers of base stations and radios that have been put into test mode with RSS. **Note:** *More in-depth BER testing of radios can be done in the R8100's PROJECT 25 conventional Test Mode option. The Test Pattern setting, BER Test status, and calculated BER percentage (see Figure 3.2.8.5-3) are provided for testing transmitters of base stations and radios that have been put into Test Mode with RSS. Modulation Fidelity, Symbol Deviation, and Symbol Rate Error measurements are also available for the transmission signal being tested; for explanations see Section 2.2.7.3 for the PROJECT 25 Test Mode (Conventional). BER test Monitor and Generate*

frequencies are specified via the RF Zone rather than the Band Plan Table. The BER specific vertical soft keys are as follows:

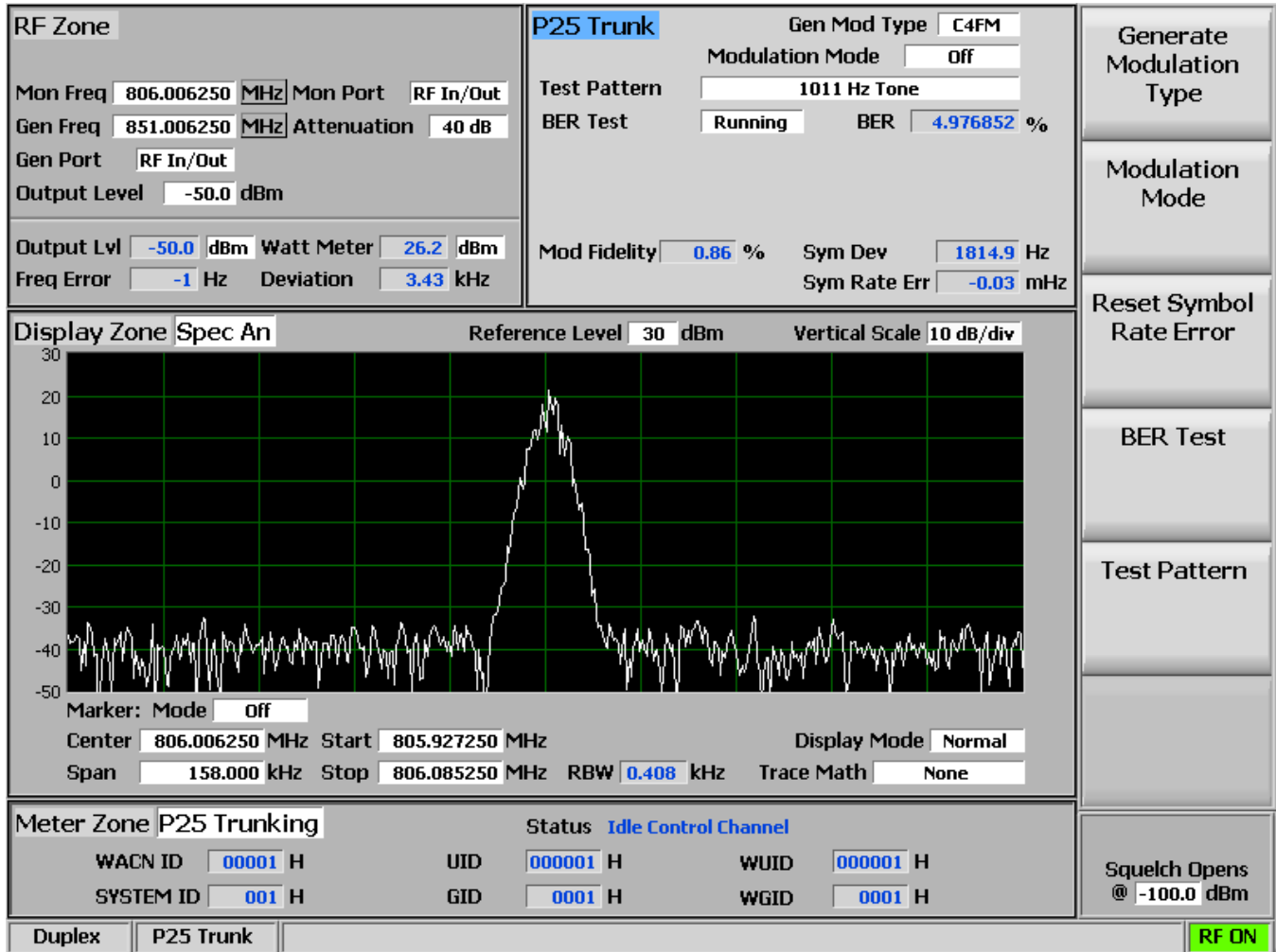

Figure 3.2.8.5-3 P25 Trunk submenu after starting BER test after registration

Modulation Mode (P25 Trunk BER submenu)

This key provides a horizontal submenu with the choice of Off or Continuous Mode for the selected Test Pattern modulation.

Test Pattern (P25 Trunk BER submenu)

This key provides selection for one of four TIA/EIA-102.CAAA compliant predefined test patterns (as shown in Figure 3.2.8.4.1-4) for BER testing of a P25 radio in transmit or Receive Mode. Use BER Test to enable transmitter testing and Modulation Mode to control receiver testing. The following patterns are available:

1011 Hz Tone is the standard tone framed test pattern of the 1011 Hz vocoder tone.

Calibration (Tone 5%) is the test pattern derived from the standard 1011 Hz Tone test pattern to verify BER measurements are operating correctly. Every 20th bit is inverted to yield 172 errors out of 3456 bits resulting in a 4.976852% BER.

Standard Tx (O.153/V.52) is the standard transmitter test pattern of continuously repeating 511-bit pseudo random number sequences based on ITU-T O.153 (formerly CCITT V.52).

Silence is the framed test pattern for silence at the vocoder.

BER Test Pattern (P25 Trunk BER submenu)

Pressing Stop ends test pattern transmission and error rate computation then restores the default P25 Trunk screen and submenu.

Select Display (Display Zone submenu)

See 2.2.4 Display Zone for standard selections, and see below for custom selections.

Eye Diagram (Display Zone selection)

The display is useful for the voice channel and while BER Testing; see PROJECT 25 Test Mode (Conventional) Section 2.2.7.3.1.3.

Distribution Plot (Display Zone selection)

This display is useful for the voice channel and while BER Testing; see PROJECT 25 Test Mode (Conventional) Section 2.2.7.3.1.3.

Select Meter (Meter Zone submenu)

See 2.2.5 Meter Zone for standard selections.

2.2.7.5 NXDN™ Test Mode (conventional)

The R8100 NXDN™ Test Package option / NXDN™ Test Mode allows testing of radios compliant with the NXDN™ radio transmission protocol. NXDN™ radios use a digital transmission format employing Four-Level Frequency Shift Keying (4FSK) modulation in an RF spectrum managed by Frequency Division Multiple Access (FDMA) technology. Both 9600 bps and 4800 bps transmission rates are supported. The R8100 NXDN™ Mode provides a grouping of test functions compliant with the Conformance Test section of the NXDN™ Common Air Interface (CAI) standard. These include power, Frequency Error, Symbol Deviation, Modulation Fidelity (FSK Error), Radio Access Number (RAN), audio/test patterns, and Bit Error Rate (BER). BER tests require the manufacturer's Radio Service Software (RSS) to place the radio in a special test mode. In addition, an Eye Diagram with graphical representation of the NXDN™ signal exists as well as a Voice Loopback function that enables the Voice Loop feature (U.S. patent 5703479) for audio verification of the radio's end-to-end operation. Both provide qualitative indication of the radio's performance. Averaging can be applied to some measurements by the System Settings. Figure 3.2.8.6-1 shows the R8100 main screen after choosing the NXDN™ Test Mode in Monitor Mode.

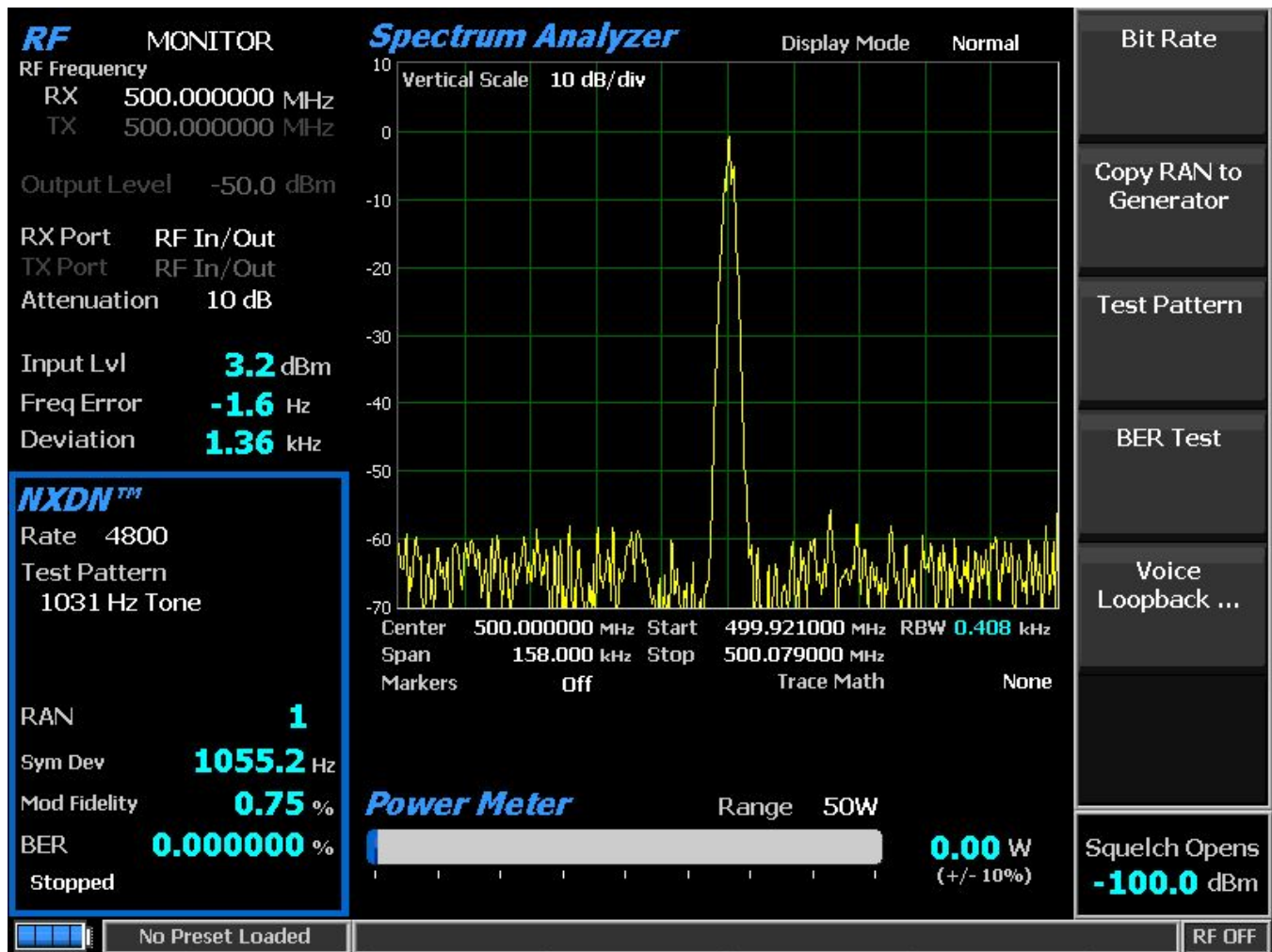

Figure 3.2.8.6-1 Main screen in Monitor Mode after selecting NXDN™ Test Mode

2.2.7.5.1 NXDN™ transmitter tests

The entire suite of NXDN™ transmitter tests are available in R8100 Monitor Mode after the NXDN™ soft key is pressed (see Figure 3.2.8.6.1-1). During radio transmission, the R8100 continuously measures the quality of the transmitted 4FSK signal. Numerical results are displayed as Symbol Deviation and Modulation Fidelity in the NXDN™ zone. Framing is decoded to display the Radio Access Number (RAN). When the Eye Diagram is selected in the Display Zone, the R8100 overlays the modulation response over four “target” crossing points for an ideal NXDN™ signal. BER tests require use of the manufacturer’s RSS to place the radio in a special test mode.

2.2.7.5.1.1 RF Zone

Input Level (RF Zone display)

Input Lvl displays the average power in the NXDN channel under test.

Note: *When the RF input power on the RF In/Out port is above +20 dBm (100 mW), the R8100 utilizes a broadband power detector for the measurement. The “Input Lvl” field in the RF Zone changes to “Watt Meter” to indicate this measurement mode. For best accuracy, disable the Pre-amplifier in Monitor Mode, and set the Gen Port in Generate Mode to RF In/Out.*

Freq Error (RF Zone display)

Freq Error displays the frequency difference of the received NXDN transmission carrier minus the R8100 Monitor Frequency.

Deviation (RF Zone display)

Deviation displays the positive peak FM frequency deviation of the received modulated carrier (i.e. from the Frequency Error mean). See negative peak frequency deviation with Display Zone Bar Graphs.

2.2.7.5.1.2 NXDN™ Zone

Symbol Deviation (NXDN™ Zone display)

NXDN™ radios broadcast voice and data using a four-level frequency deviation of the carrier to represent symbols containing data bits as shown in the table below. The nominal symbol deviation value for an NXDN™ radio using 4FSK modulation is 1050 Hz in a 6.25kHz channel and 2400 Hz in a 12.5kHz channel. Since the deviation of an NXDN™ 4FSK signal is data dependent, that aspect is factored when measuring overall carrier deviation. The Symbol Deviation field provides the deviation measurement at symbol decision times.

Bits	Symbol	Deviation (6.25kHz)	Deviation (12.5kHz)
01	+3	+1050 Hz	+2400 Hz
00	+1	+350 Hz	+800 Hz
10	-1	-350 Hz	-800 Hz
11	-3	-1050 Hz	-2400 Hz

Table 2.2.7.5.1.2-1 NXDN™ Symbols

Modulation Fidelity (NXDN™ Zone display)

Modulation Fidelity (FSK error) represents how accurate a transmitter reproduces an ideal theoretical modulation waveform. The measurement is performed by first removing frequency error and symbol deviation gain error from the received signal, then computing the RMS difference between the deviation of the resulting signal at each symbol decision point and the ideal deviations of those symbols; no bit errors should exist. On the R8100, this is reported as an RMS error in % relative to the mean deviation across symbols.

RAN (NXDN™ Zone display)

Radio Access Number is a six-bit field for the NXDN conventional system protocol of the RTCH/RDCH frame in the SACCH field. The R8100 analyzes all NXDN transmissions regardless of the transmitted number. See Generate Mode Receiver Tests for more details.

BER (NXDN™ Zone display)

See BER Test.

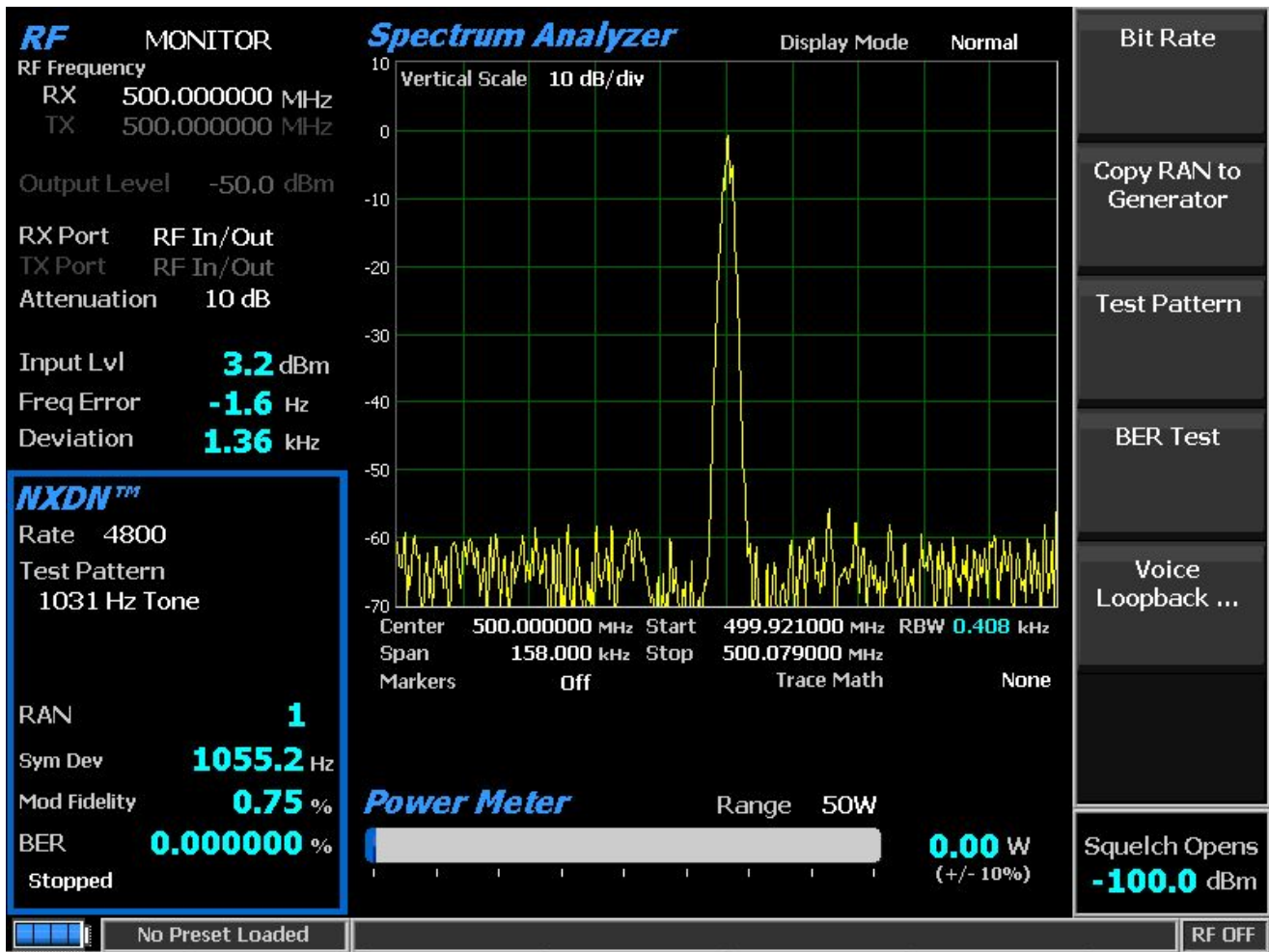

Figure 3.2.8.6.1-1 NXDN™ Monitor Mode

Bit Rate (NXDN™ submenu)

This key selects the bit rate used by the NXDN™ radio, either 4800 bps (6.25 kHz channel) or 9600 bps (12.5 kHz channel).

Test Pattern (NXDN™ submenu)

This key provides selection of bit patterns for testing the radio in Transmit Mode while under RSS control. The following patterns are available:

1031 Hz Tone is the framed test pattern of the 1031 Hz half-rate vocoder tone (NXDN™ CAI compliant).

1011 Hz Tone (Only selectable for Bit Rate 9600 bps) is the framed test pattern of the 1011 Hz full-rate vocoder tone (NXDN™ CAI compliant).

Calibration (O.153 2%) is a test pattern derived from the 511 (O.153) pattern to yield a 2.005871% BER used to verify BER measurements are operating correctly.

511 (O.153) is the unframed test pattern of continuously repeating 511-bit pseudo random number sequences generated with a nine-bit shift register (PN9) based on ITU-T O.153 (formerly CCITT V.52) used to perform BER testing for checking the modulation, encoding, and timing of the transmit signal (NXDN™ CAI compliant).

BER Test (NXDN™ submenu)

This key provides Start or Stop Bit Error Rate (BER) testing in the NXDN™ mode of the R8100. This Bit Error Rate test checks the modulation, encoding, and timing of the transmit signal during the data transmission period. When performing the BER Test, the radio transmitter under test must be placed into a test diagnostic mode with the correct TX test pattern selected using the manufacturer's Radio Service Software (RSS). The test is done at nominal power with the radio transmitting the test pattern into the service monitor. (It is acceptable to have an attenuator between the radio under test and the service monitor.) BER test results, the percentage of bit differences between the bits of the selected Test Pattern and the bits from the received synchronized FDMA signal, are shown in the NXDN™ zone in the BER field.

Voice Loopback (NXDN™ submenu)

This menu selection enables the Voice Loopback feature in NXDN™ mode (U.S. patent 5703479). Once enabled the R8100 automatically records voice channel data when the radio under test transmits a signal above the squelch level setting. A green Voice Playback Active indicator appears in the Test Mode Zone when Voice Loopback is enabled on the Voice Loopback screen. The Record Duration setting determines the maximum length of the recording, and a bar graph meter shows the recording's progress (see Figure 3.2.8.6.1-2). The recording continues if the transmission is longer than the duration, but only the most recent is retained. When the radio is un-keyed, the R8100 automatically switches to Generate Mode and transmits the captured voice channel information or speech back to the radio. This provides a quick end-to-end test of the NXDN™ radio transmitter and receiver.

Voice channel recordings can be played back at any time by pressing the Play Last Recording soft key (this selection only appears after a recording has been made). **Note:** *Recorded information is lost if the R8100 is power cycled or if the Generate Mode is selected and a new test pattern is enabled by setting the Modulation Mode too Continuous or Burst.*

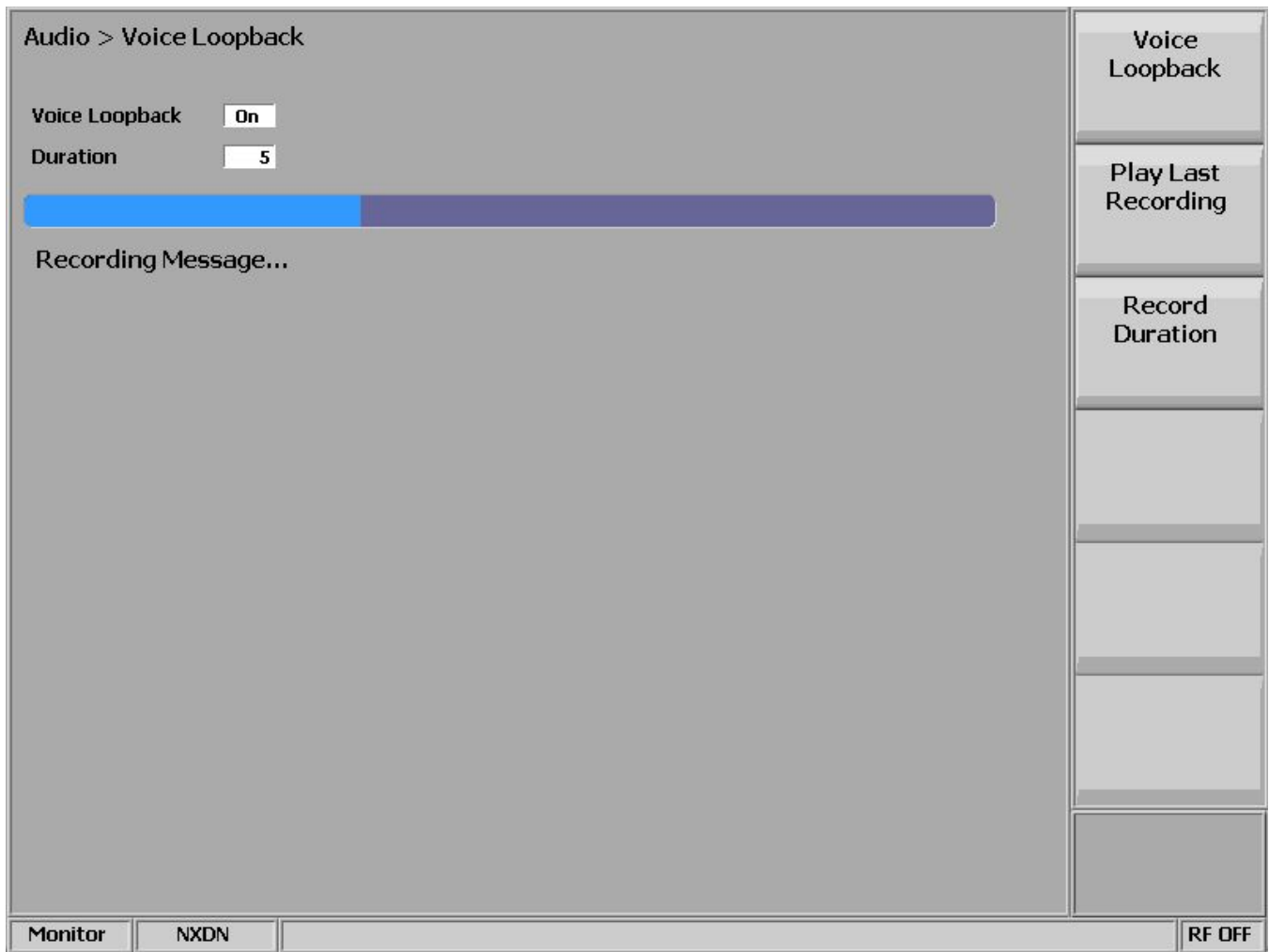

Figure 3.2.8.6.1-2 NXDN™ Voice Recording

Play Last Recording (Voice Loopback submenu)

This selection appears only after a recording has been made. Pressing the soft key places the R8100 in Generate Mode and modulates the carrier with the most recently recorded voice channel data after the Voice Loopback function is enabled. The total transmission time is equal to the length of recorded data, and a bar graph indicates the remaining transmission time during playback. Speech recorded from a transmitting NXDN™ radio under test should be heard from its receiver if the radio is operating properly.

Record Duration (Voice Loopback submenu)

This selection sets the maximum length of a recording. The time can be varied from one to 10 seconds in a data entry window using the arrow keys, keypad, or spin knob. If the transmission is longer than this time, only the most recent is retained.

2.2.7.5.1.3 Display Zone

Select Display (Display Zone submenu)

See 2.2.4 Display Zone for standard selections, and see below for custom selections.

Eye Diagram (Display Zone selection)

The Eye Diagram provides a visual display of the received NXDN™ signal and overlays the modulation response during two symbol periods over the four “target” crossing points for an ideal NXDN™ signal (see Figure 3.2.8.6.1-3). Navigate to the Display Zone while in NXDN™ mode to select the Eye Diagram for viewing with the other NXDN™ measurements on the main screen. The Eye Diagram can indicate whether a transmitter has significant unbalances or offsets in the modulation circuitry by noting how tightly grouped the waveform is around the crossing points.

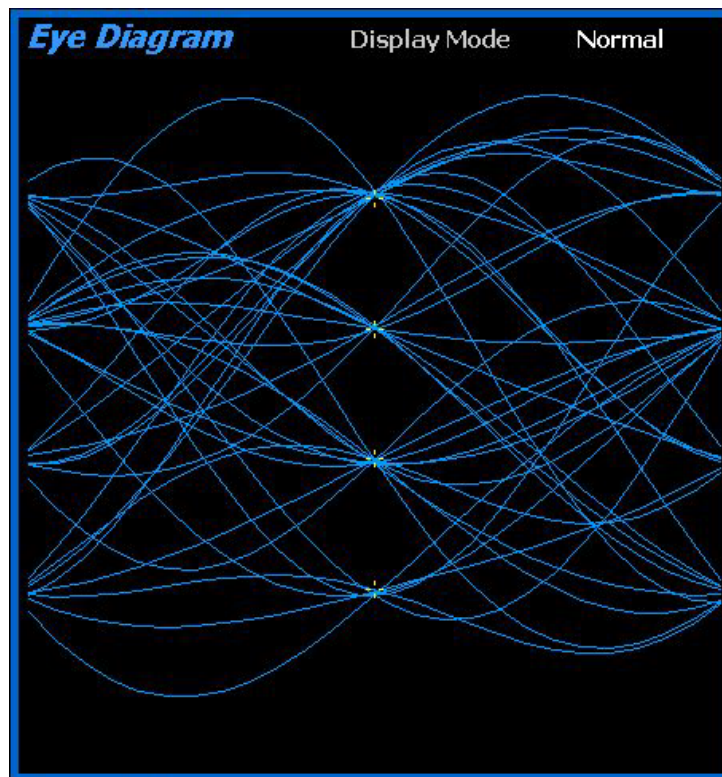

Figure 3.2.8.6.1-3 NXDN™ Eye Diagram in Display Zone

Display Mode (Eye Diagram submenu in Display Zone)

Display Mode selects the display presentation with the following horizontal menu choices:

Normal indicates that the display updates continuously.

Fade Away is similar to the Persistence Mode on an oscilloscope(see Figure 3.2.8.6.1-4). The intensity of each trace fades away or decays as new traces are received. The effect is to intensify the display in the area where the waveform spends most of its time. **Note:** *Whenever the Display Mode is changed, the R8100 reconfigures the presentation. This process takes approximately 10 seconds and is complete when the new setting appears in the Display Mode field.*

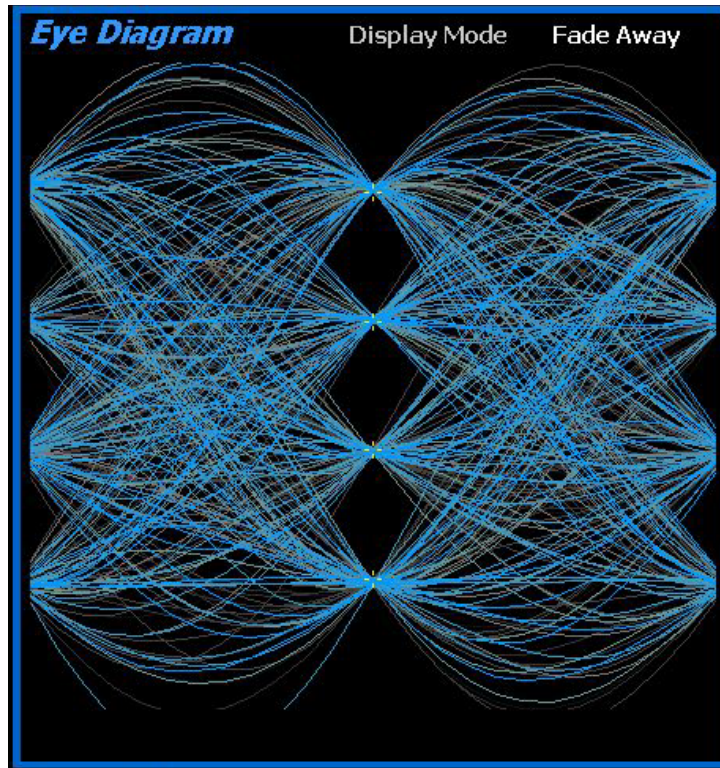

Figure 3.2.8.6.1-4 NXDN™ Eye Diagram with display in Fade Away Mode

2.2.7.5.1.4 Meter Zone

See 2.2.5 Meter Zone for standard selections.

2.2.7.5.2 NXDN™ receiver tests

These tests are performed with the R8100 in Generate Mode (see Figure 3.2.8.6.2-1). The R8100 generates NXDN™ CAI compliant test patterns and can be adjusted over a wide range of RF levels to determine the sensitivity and data transmission integrity of the NXDN™ radio.

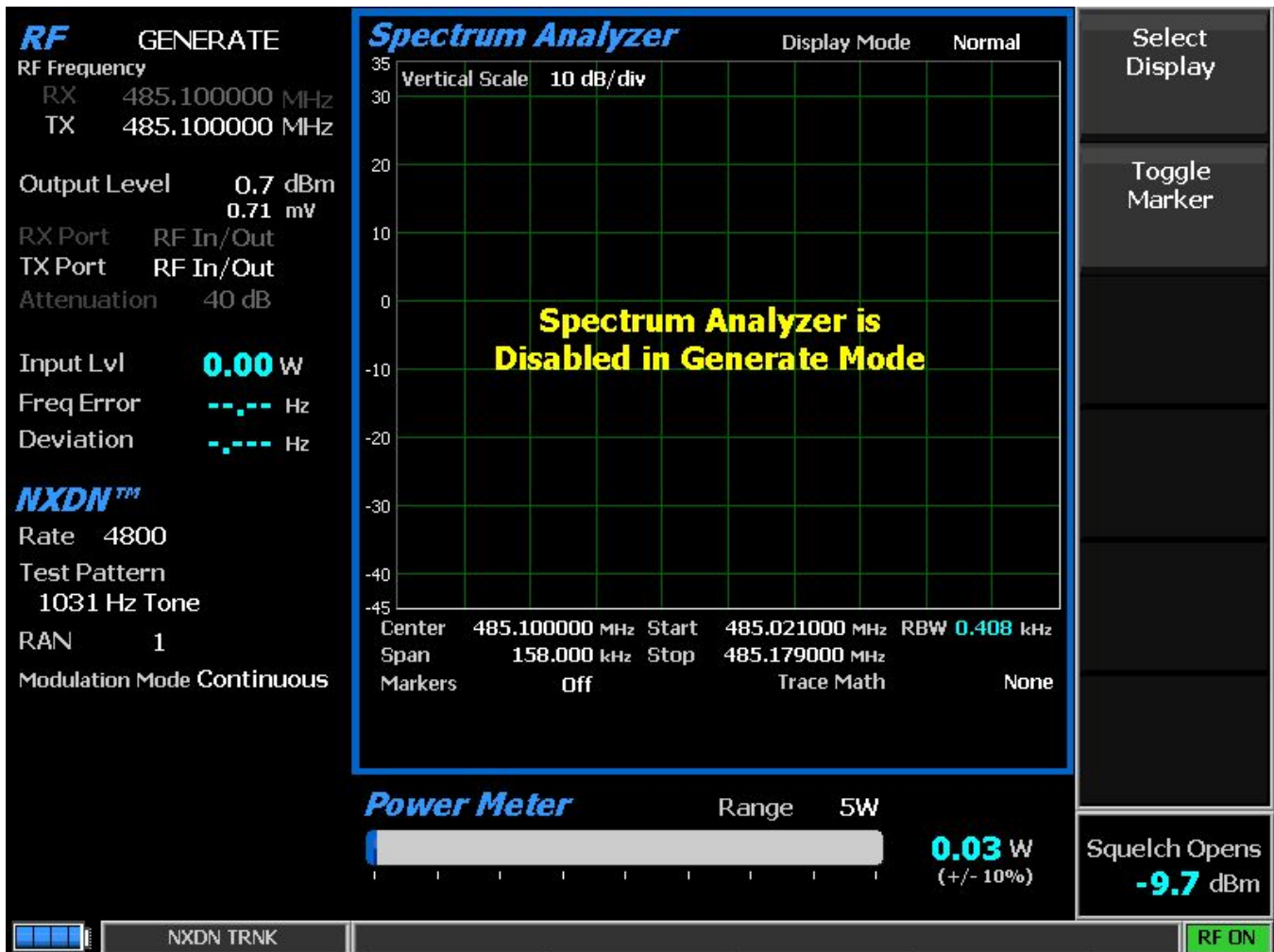

Figure 3.2.8.6.2-1 NXDN™ Generate Mode

Bit Rate (NXDN™ submenu)

This key selects the bit rate used by the NXDN™ radio, either 4800 bps (6.25 kHz channel) or 9600 bps (12.5 kHz channel).

RAN (NXDN™ submenu)

Radio Access Number is a six-bit field in the NXDN protocol RTCH/RDCH frame. In a conventional system, it is digital ID information equivalent to CTCSS/PL and CDCSS/DPL of analog FM radio systems. Selecting a RAN value to use is equivalent to selecting a CTCSS/PL tone or DCS/DPL code in an analog system. The basic premise is that stations sharing the same frequency but using different numbers do not have to listen to each other. In the digital squelch scheme, a number is sent by a transmitter to control the squelch opening of a receiver. Then number is encoded and sent by the transmitter, then decoded and used by the receiver. When the scheme is used, the receiver must receive the programmed number or it will mute the audio output (i.e. the operator will not hear anything from the radio unless the transmission contained the programmed number). Selectable numbers are 0-63. Numbers 1-63 may be used to identify/access groups of radios. Zero is equivalent to digital CSQ; if the receiver uses zero, then all stations on the frequency are heard regardless of the transmitted number.

Note: A transmitter that sends zero will be heard only by radios with the radio access scheme disabled.

Test Pattern (NXDN™ submenu)

Test Pattern provides selection of bit patterns for testing the radio in Receive Mode. Some may require the radio to be under RSS control. The following patterns are available:

1031 Hz Tone is the framed test pattern of the 1031 Hz half-rate vocoder tone (NXDN™ CAI compliant).

1011 Hz Tone (Only selectable for Bit Rate 9600 bps) is the framed test pattern of the 1011 Hz full-rate vocoder tone (NXDN™ CAI compliant).

Calibration (O.153 2%) is the test pattern derived from the 511 (O.153) pattern to yield a 2.005871% BER used to verify BER measurements are operating correctly.

511 (O.153) is the unframed test pattern of continuously repeating 511-bit pseudo random number sequences generated with a nine-bit shift register (PN9) based on ITU-T O.153 (formerly CCITT V.52) used to perform BER testing for checking the modulation, encoding, and timing of the transmit signal (NXDN™ CAI compliant).

511 (O.153) Framed is a framed test pattern consisting of 73 384-bit frames that contain the 20-bit frame synchronization word and 364 bits of 52 copies of the 511-bit sequences (FSW + PN9) used to perform BER testing for checking the modulation, encoding, and timing of the transmit signal.

Interference (Interfering Modulation Data Stream) is a 32767-bit pseudo-random number pattern defined by ITU-T.

Max Freq Deviation is the maximum frequency deviation test pattern of a continuously repeating stream of high deviation symbols (+3, +3, -3, -3, ...).

1/3 Freq Deviation is the test pattern of a continuously repeating stream of low deviation symbols (+1, +1, -1, -1, ...) for a 1/3 maximum frequency deviation.

Modulation Mode (NXDN™ submenu)

A horizontal submenu provides choice of Off, Continuous, or Burst Mode for the selected Test Pattern modulation. **Note:** *Enabling a test pattern in Generate Mode will erase any previously captured Voice Recordings.*

2.2.7.6 NXDN™ Test Mode (trunking)

2.2.7.6.1 NXDN™ transmitter tests

The optional R8100 NXDN™ Type C Trunk Test Mode allows testing of trunked NXDN™ compliant radios. NXDN™ radios use a digital transmission format employing Continuous four level FM (C4FM) modulation. The R8100 NXDN™ Type C Trunk Mode simulates the functions of a NXDN™ central controller with the control and voice channel protocols needed for various tests. Also included are NXDN compliant test patterns for Bit Error Rate (BER) testing, Frequency Error and Power meters, an Eye Diagram with graphical representation of the NXDN™ signal, and modulation signal quality meters.

A Voice Loop feature (U.S. patent 5703479) is engaged for audio verification of the radio's end-to-end operation after the subscriber unit transmits. During a Voice Call the R8100 automatically records voice channel data while the subscriber unit PTT is pressed, then retransmits it to provide audio verification of the radio's end-to-end operation.

The manufacturer's Radio Service Software (RSS) is required to perform some tests in NXDN™ Type C Trunk Mode because certain measurements (BER) require placing the radio in a special test mode. Figure 3.2.8.6.3-1 shows the R8100 main screen after choosing the NXDN™ Type C Trunk Test Mode.

As usual, the RF Zone can be used to configure various settings such as output level, attenuation, and ports, etc. However, the soft keys for Monitor and Generate frequencies are disabled. These frequencies are determined by settings in the NXDN™ Type C Trunk Zone, either the control/voice channel frequency settings or the control/voice channel number settings according to the Band Plan Table.

Note: *RF Zone Monitor and Generate Frequency settings can be changed for the BER Test. Otherwise, they are read-only and updated in real-time to show the control channel frequencies or the voice channel frequencies that are in use.*

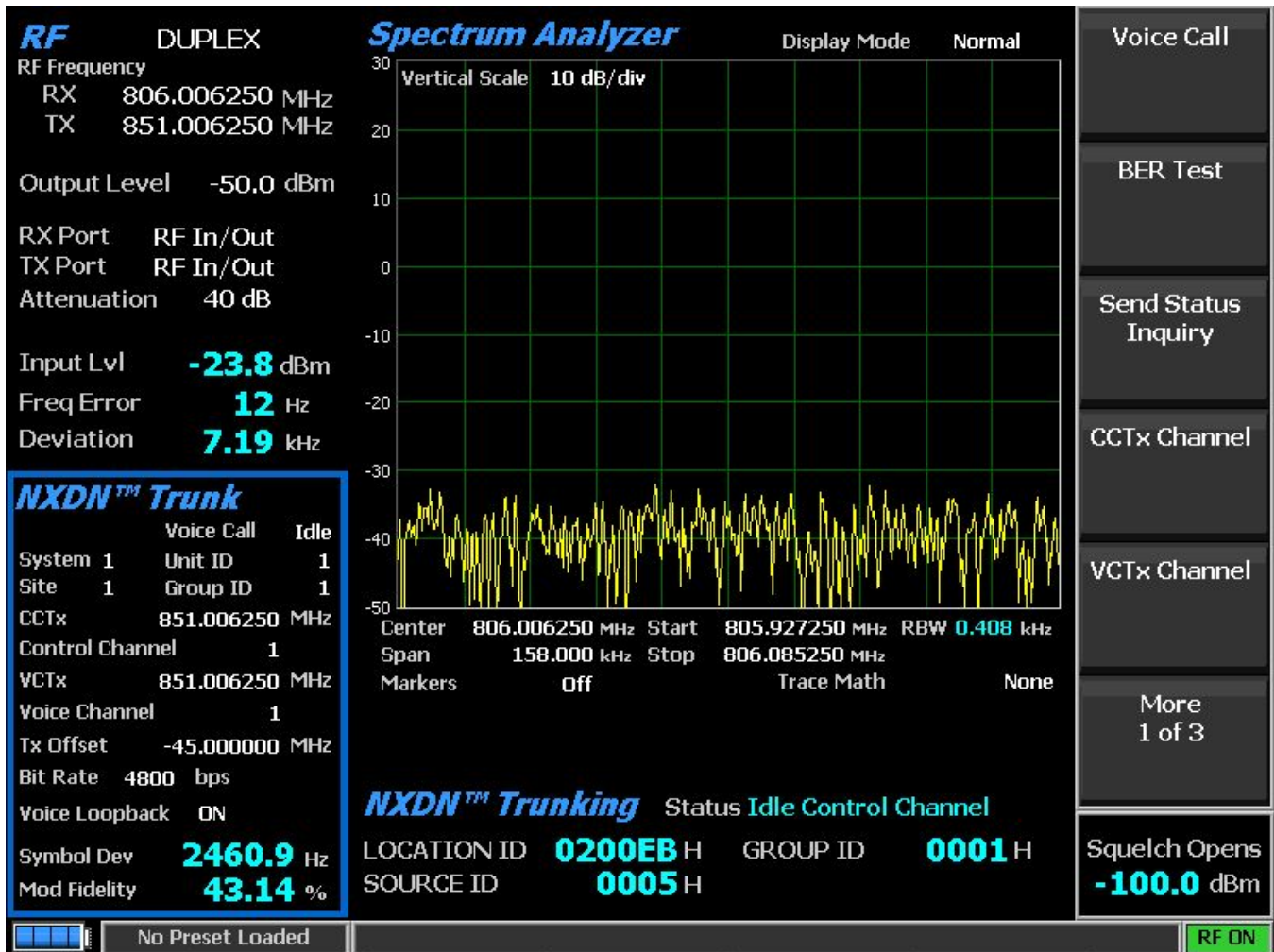

Figure 3.2.8.6.3-1 Main screen after selecting NXDN Trunk Test Mode

When the NXDN™ Type C Trunk Test Mode is selected, the R8100 is automatically placed in Duplex Mode and begins transmitting idle messages on the control channel with no encryption. Pressing the NXDN™ Trunk soft key on the main screen displays a submenu with the following settings (see Figure 3.2.8.6.3-2).

A NXDN™ Type C trunked radio connected to the R8100 and turned on automatically registers with the analyzer if the Band Plan settings are configured for the system under test. The registration progress is shown in the Meter Zone “Status” field, and the radio ID parameters are populated on the display.

Once the radio is registered, a voice test using the Voice Loop feature can be performed. Keying the radio under test transitions it to the voice channel, and the R8100 automatically records up to the last 10 seconds of conversation, as long as the signal is above the squelch level setting. Unlike other test modes, the Voice Loop feature is always enabled in NXDN™ Type C Trunk Test Mode. The maximum length of a recording is fixed at 10 seconds. The recording continues if the transmission is longer than this duration, but only the most recent is retained. When the radio is un-keyed, the R8100 initiates a voice call and replays the last recorded conversation; to play another conversation, another recording must be made. This provides a quick end-to-end test of the NXDN™ radio transmitter and receiver. This Voice Loop feature can even be used to verify basic functionality of a NXDN™ radio with an encrypted voice channel.

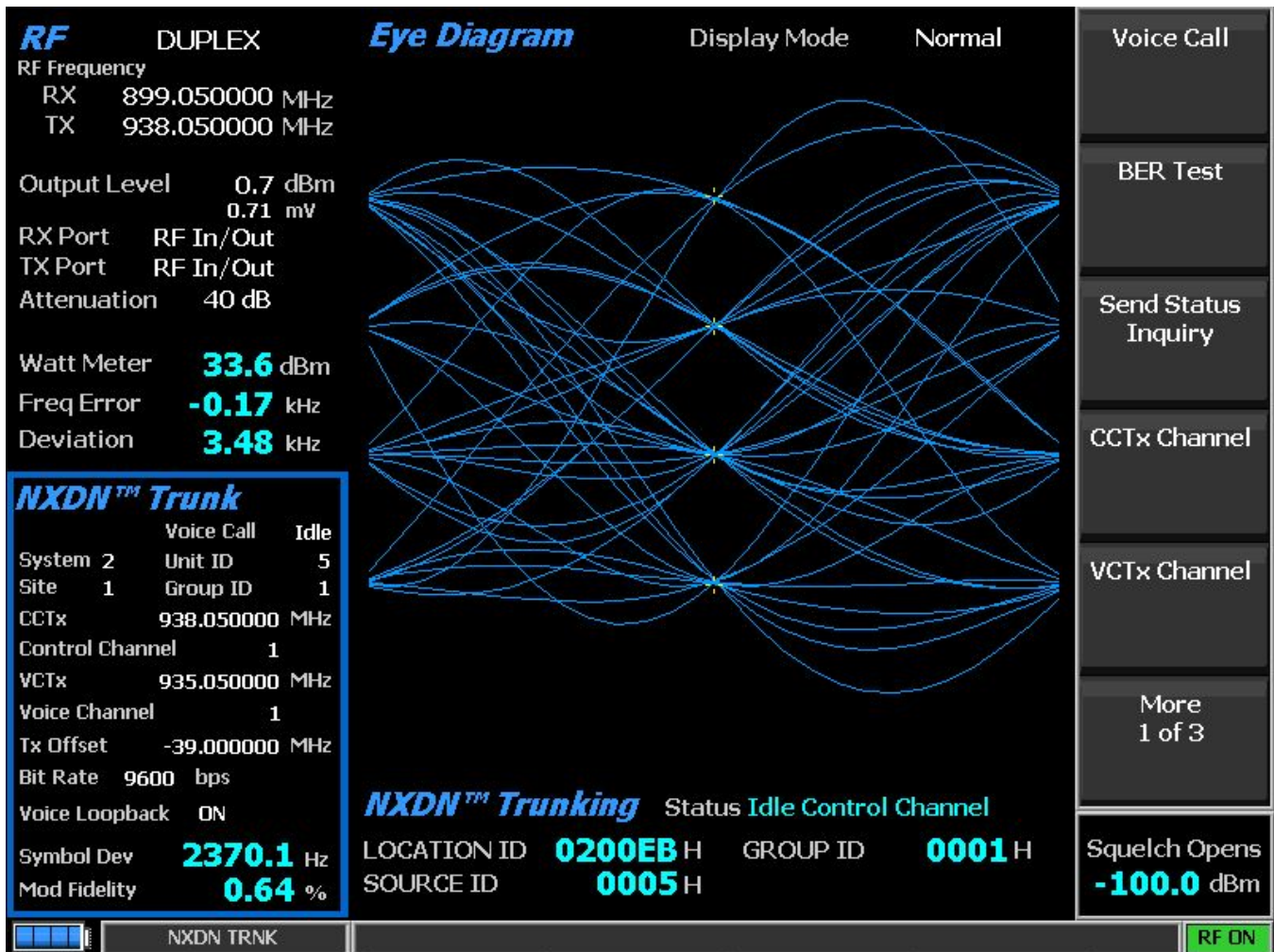

Figure 3.2.8.6.3-2 Main screen after pressing NXDN™ Trunk soft key

Voice Call

This key selects Start and Stop for the Voice Call test. The R8100 sends out a control channel message causing the subscriber radio to transition to a voice channel. The analyzer transmits a 1031 Hz tone that should be heard on the radio to confirm this transition.

BER Test

This key selects Stop and Start for the BER test. Pressing Start displays a new NXDN™ Type C Trunk BER submenu. The default NXDN™ Type C Trunk Zone is changed to display BER specific data fields, including the Modulation Mode, selected Test Pattern, BER Test status, and calculated BER percentage (see Figure 3.2.8.6.3-3). The test patterns are provided for testing base stations and radios in test mode with RSS. **Note:** More in-depth BER testing of radios can be done in the optional NXDN™ test mode. BER test Monitor and Generate Frequencies are specified via the RF Zone rather than the trunking-specific channel numbers. The BER specific vertical soft keys are as follows:

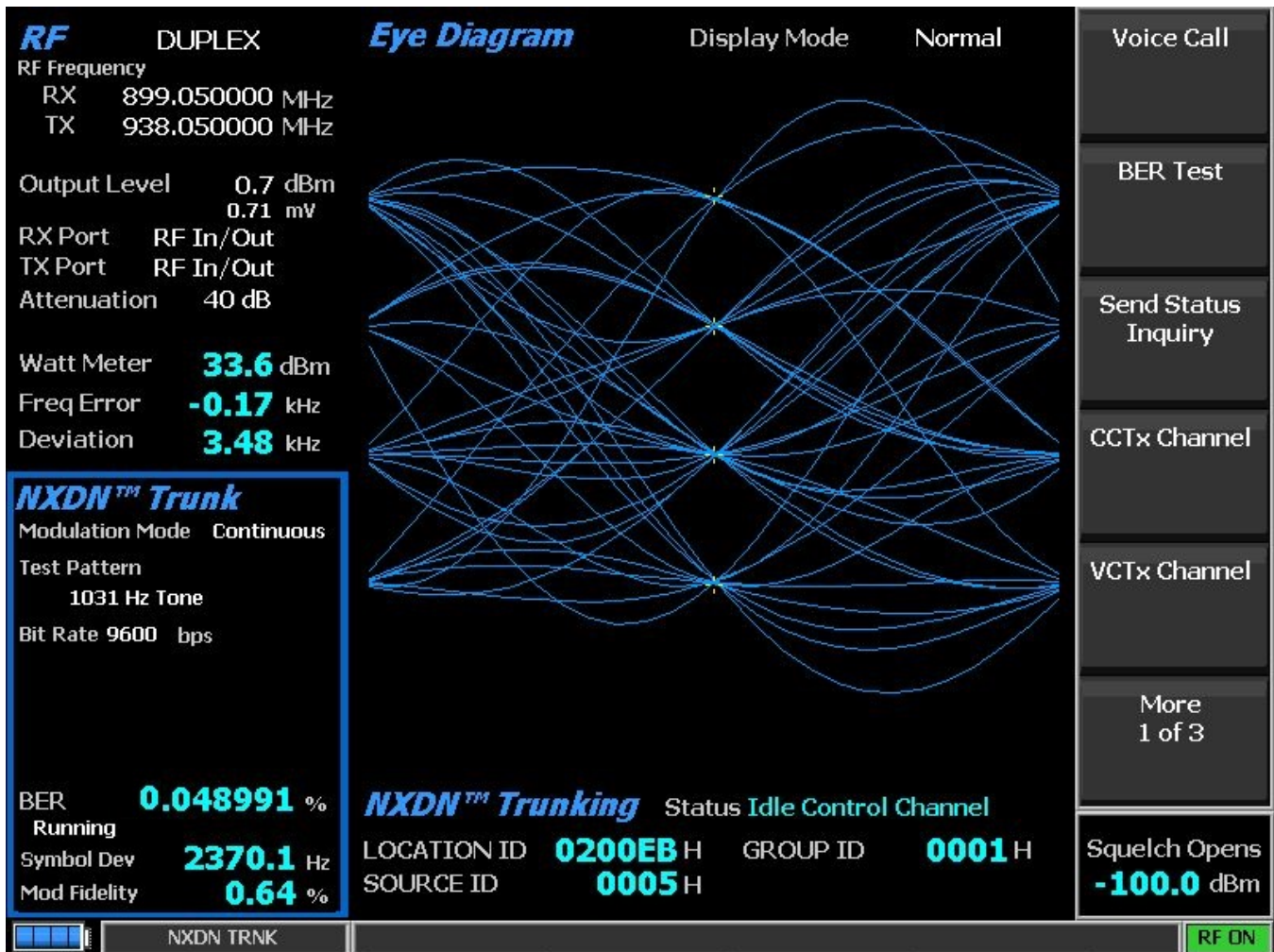

Figure 3.2.8.6.3-3 NXDN™ Trunk submenu after starting BER test

Modulation Mode (NXDN™ Trunk BER submenu)

A horizontal submenu provides choice of Off or Continuous Mode for the selected Test Pattern modulation.

Test Pattern (NXDN™ Trunk BER submenu)

This key provides selection of an NXDN™ compliant predefined test pattern for BER testing of an NXDN™ radio in Transmit or Receive Mode. Use BER Test to enable transmitter testing and Modulation Mode to control receiver testing. The following patterns are available:

1031 Hz Tone is the framed test pattern of the 1031 Hz half-rate vocoder tone (NXDN™ CAI compliant).

1011 Hz Tone (Only selectable for Bit Rate 9600 bps) is the framed test pattern of the 1011 Hz full-rate vocoder tone (NXDN™ CAI compliant).

Calibration (O.153 2%) is the test pattern derived from the 511 (O.153) pattern to yield a 2.005871% BER used to verify BER measurements are operating correctly.

511 (O.153) is the unframed test pattern of continuously repeating 511-bit pseudo random number sequences generated with a nine-bit shift register (PN9) based on ITU-T O.153 (formerly CCITT V.52) used to perform BER testing for checking the modulation, encoding, and timing of the transmit signal (NXDN™ CAI compliant).

BER Test (NXDN™ Trunk BER submenu)

This key selects Stop and Start for the BER test. **Note:** *Pressing Stop ends the BER test and restores the default NXDN™ Type C Trunk submenu.*

Send Status Inquiry

This key initiates a status inquiry to the subscriber radio under test to verify it is capable of registering and receiving a message from a NXDN™ base station. Messages in Meter Zone “Status” field show the activity during a Status Inquiry.

CCTx Channel

This key sets the Control Channel number from 0 to 1023 using the ▲▼ (Up/Down) and ◀▶ (Left/Right) keys, numeric keypad, and spin knob.

VCTx Channel

This key sets the Voice Channel number from 0 to 1023 using the ▲▼ (Up/Down) and ◀▶ (Left/Right) keys, numeric keypad, and spin knob.

Control Chnl TX Frequency

This key sets the base station control channel generate frequency directly in MHz using the ▲▼ (Up/Down) and ◀▶ (Left/Right) keys, numeric keypad, and spin knob.

Control Chnl TX Frequency = Radio Control Channel TX Frequency - Transmit Offset

Voice Chnl TX Frequency

This selection sets the base station voice channel generate frequency directly in MHz using the ▲▼ (Up/Down) and ◀▶ (Left/Right) keys, numeric keypad, and spin knob.

Voice Chnl TX Frequency = Radio Voice Channel TX Frequency - Transmit Offset

Transmit Offset

This selection sets the frequency offset from the radio receive frequency to the radio transmit frequency in MHz using the ▲▼ (Up/Down) and ◀▶ (Left/Right) keys, numeric keypad, and spin knob. Conversely, the setting defines the offset from the base station transmit frequency to the base station receive frequency.

Radio TX frequency = Radio RX frequency + Transmit Offset

Base Station TX frequency = Base Station RX frequency - Transmit Offset

System Code

This key sets the System Code within the NXDN™ system being tested. The range of values is from 000 to 999. Alphanumeric entries are made using the ▲▼ (Up/Down) and ◀▶ (Left/Right) keys, numeric keypad, and spin knob.

Site Code

This key sets the identity of the site within the RF Subsystem. The range of values is from 0 to 9. Alphanumeric entries are made using the ▲▼ (Up/Down) and ◀▶ (Left/Right) keys, numeric keypad, and spin knob.

Unit ID

This key sets the temporary Unit IDentity assigned by the R8100 to the subscriber unit being tested. The range of values is from 0 to 65535. Alphanumeric entries are made using the ▲▼ (Up/Down) and ◀▶ (Left/Right) keys, numeric keypad, and spin knob.

Group ID

This key sets the temporary Group IDentity assigned by the R8100 to the subscriber unit being tested. The range of values is from hexadecimal 0 to 65535. Alphanumeric entries are made using the ▲▼ (Up/Down) and ◀▶ (Left/Right) keys, numeric keypad, and spin knob.

Bit Rate (bps)

This key selects the system communication bit rate as 4800 bps or 9600 bps. 4800 bps is used for 6.25kHz systems, and 9600 bps is used for 12.5kHz systems.

Voice Playback

This key sets the state of the Voice Playback feature. When the voice playback feature is turned ON, voice traffic from the radio is recorded. At the end of the radio's transmission, the R8100 will initiate a voice call to the radio and replay the recorded audio. The feature may be turned OFF if audio playback is not desired.

Eye Diagram (Display Zone selection)

The Eye Diagram provides a visual display of the received NXDN™ signal and overlays the modulation response during two symbol periods over the four “target” crossing points for an ideal NXDN™ signal (see Figure 2.2.7.5.1.4-1). View the Eye Diagram with the other NXDN™ measurements on the main screen by selecting it in the Display Zone. The Eye Diagram can indicate whether a transmitter has significant unbalances or offsets in the modulation circuitry by noting how tightly grouped the waveform is around the crossing points.

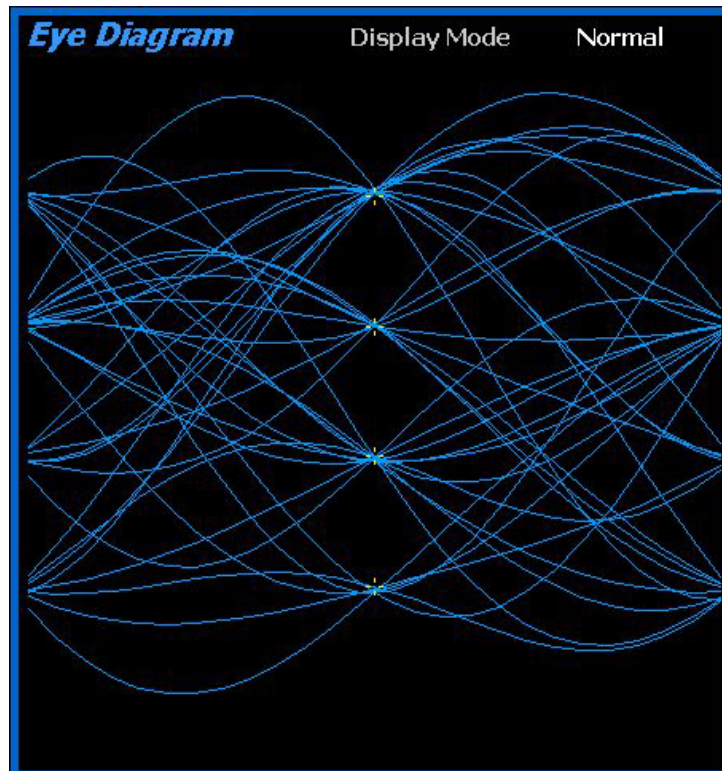

Figure 2.2.7.5.1.4-1 NXDN Eye Diagram in Display Zone

2.2.7.7 TETRA Test Mode

The R8100 TETRA Test Package option / TETRA Test Mode allows testing of radios compliant with the ETSI Terrestrial Trunked Radio (TETRA) Direct Mode Operation (DMO) radio transmission protocol per ETSI specification EN 300 396. TETRA radios use a digital transmission format employing $\pi/4$ DQPSK modulation at 18000 four-bit symbols per second with a channel access method of Time Division Multiple Access (TDMA) technology with four slots per frame. Pressing the TETRA soft key initiates the TETRA Test Mode. On the R8100 main display the Standard Mode's Audio Zone and Audio Zone soft key are replaced by a TETRA soft key and TETRA specific content (see Figure 2.2.7.7-1). In addition, Power Profile, Modulation Spectrum, and Constellation displays are available in Display Zone.

The manufacturer's Radio Service Software (RSS) is not required to perform tests in TETRA Mode. Tests include slot power, Frequency Error, Residual Carrier Magnitude, error vector magnitude (EVM), Unwanted Power, Power Profile, Modulation Spectrum, and Constellation. Averaging can be applied to some measurements, by the System Settings and/or TETRA settings.

Note: TETRA QAM modulation is not supported.

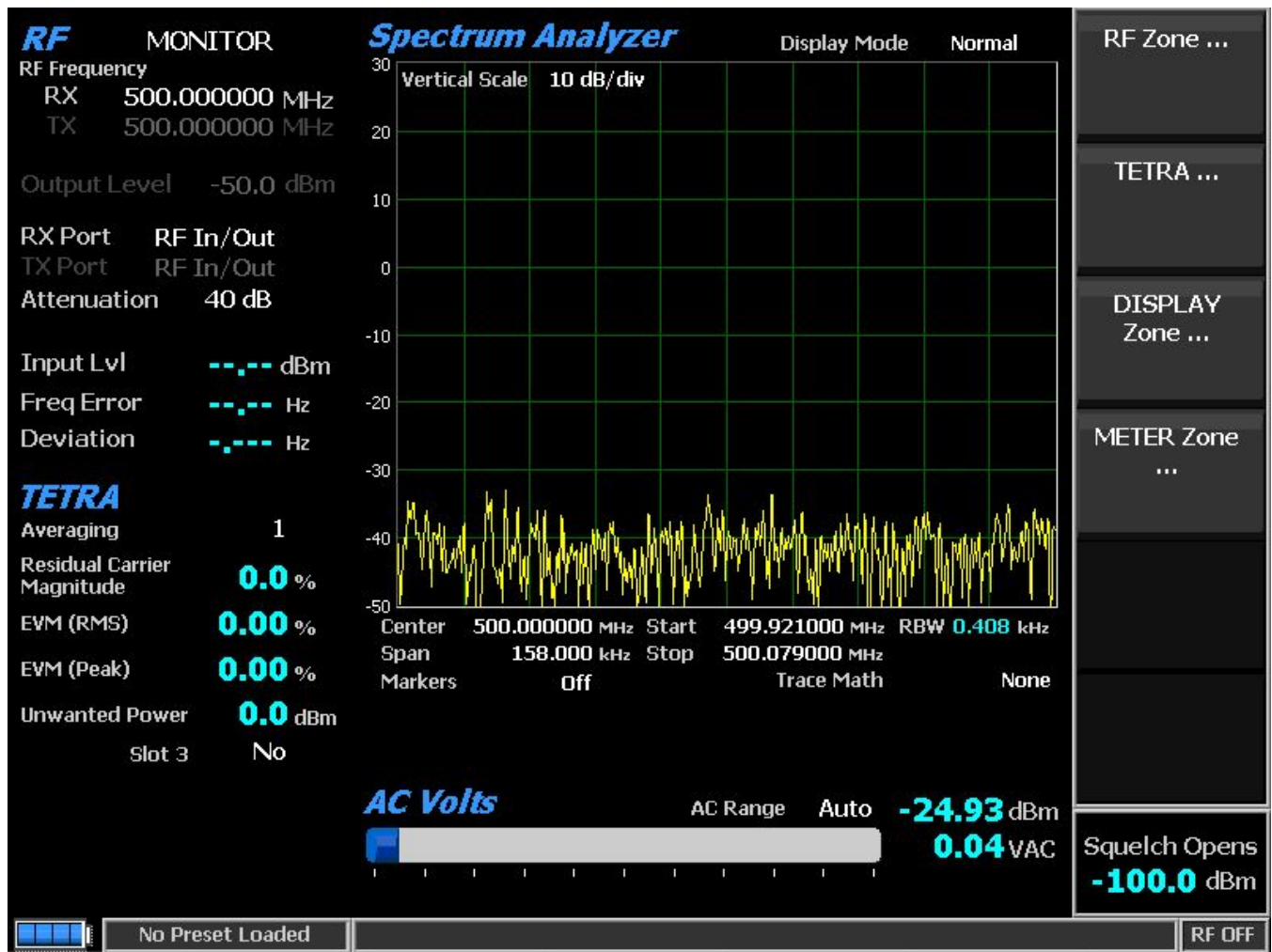

Figure 2.2.7.7-1 Main screen in Monitor Mode after selecting TETRA Test Mode

2.2.7.7.1 TETRA transmitter tests

These tests are performed with the R8100 in Monitor Mode. During radio transmission, the R8100 continuously measures the quality of the radio's transmitted $\pi/4$ DQPSK signal. The service monitor synchronizes to the DMO TDMA Normal burst (235 symbols, 470 bits) in slot 1; Trunked Mode Operation (TMO), Synchronization, and Linearization bursts are not measured.

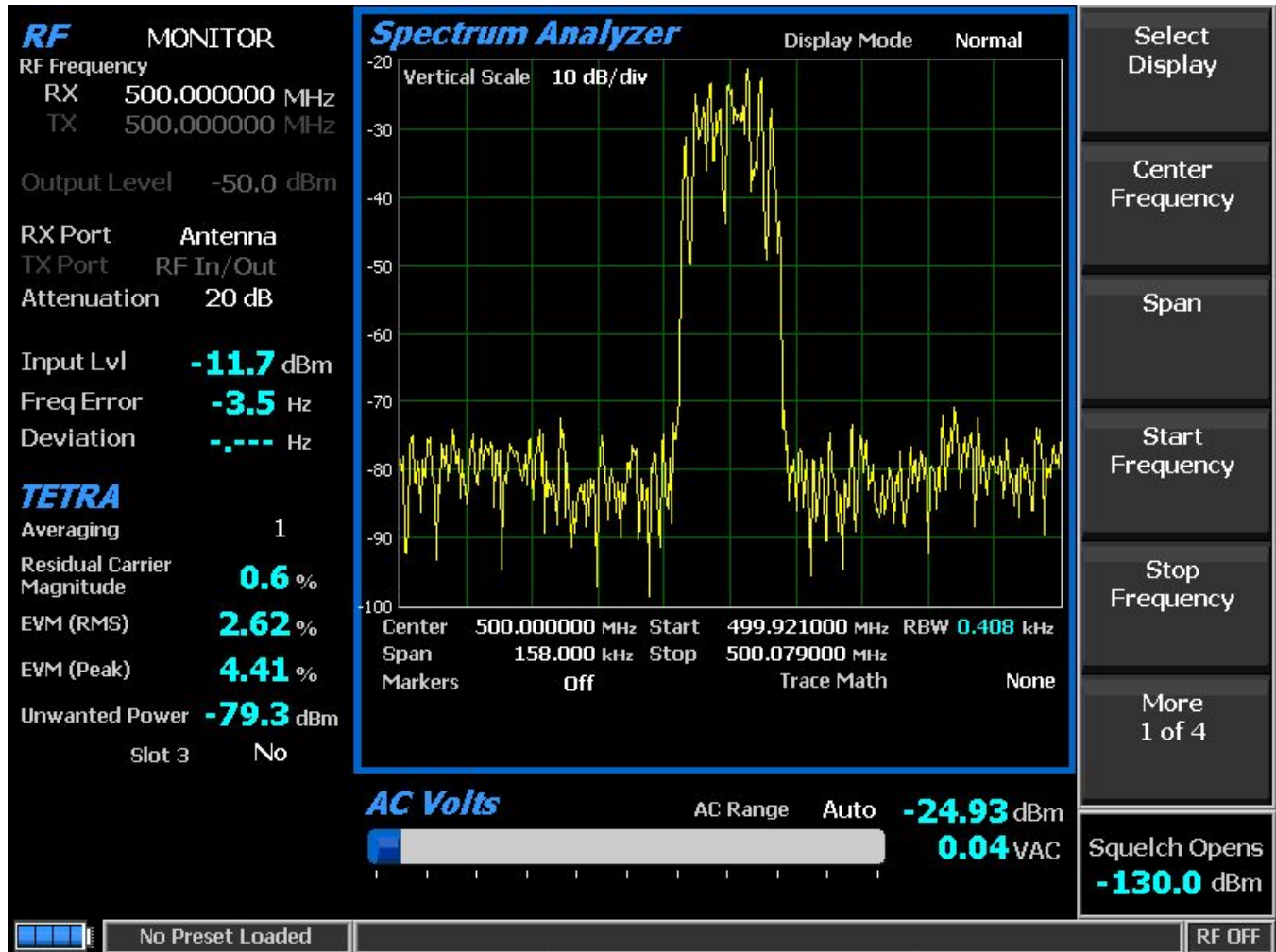

Figure 2.2.7.7-2 Submenu after pressing TETRA soft key in Monitor Mode

2.2.7.7.1.1 RF Zone

Input Level

Input Lvl displays the power level in the burst of the synchronized TDMA slot 1 of the received signal. The measurement is done at the optimal symbol times and positions to exclude adverse effects of frequency error and residual carrier.

Note: Averaging over multiple bursts may be performed per 2.2.7.7.1.2 to comply with the standard.

Note: Input Level is used for Squelch, and Squelch prevents TETRA Zone measurement updates.

Note: When the RF input power on the RF In/Out port is above +20 dBm (100 mW), the R8100 utilizes a broadband power detector for the measurement. The “Input Lvl” field in the RF Zone changes to “Watt Meter” to indicate this measurement mode. For best accuracy disable the Pre-amplifier in Monitor Mode, and set the Gen Port in Generate Mode to RF In/Out.

Note: A TETRA TDMA transmission alternates between a used and unused time slot, so the RF Zone field will switch between them. Unused slots have no power, so the display will flash between “Input Lvl” and “Watt Meter.” In this condition, the Input Level reading should be used since null slots can cause the Watt Meter indication to read approximately 6 dB less than the power in the used slots.

Freq Error

Freq Error displays the frequency difference of the received TETRA transmission carrier minus the R8100 Monitor Frequency, refined over numerous bursts for improved accuracy. The measurement is done at the optimal symbol times.

Note: The specification allows ± 1000 Hz error; the measurement limit is ± 1100 . Thus, the sign of the measurement may be used to tune a radio that is worse toward compliance and into measurement range.

Note: Averaging is performed on this field per 2.2.8.2 as it is for other test modes.

Note: For other standard RF Zone settings, see Section 2.2.1: RF Zone / Monitor Mode.

2.2.7.7.1.2 TETRA Zone

Residual Carrier Magnitude

Residual Carrier Magnitude (sometimes referred to as residual carrier power or carrier leakage) is the measurement of the vector offset between the ideal and actual signal. In terms of its constellation, residual carrier would appear as an ideal diagram offset from the origin (0,0). The measurement is done at the optimal symbol times.

EVM (RMS)

Error Vector Magnitude is the measurement of the deviation of the actual signal (I/Q vectors) from the ideal signal (see Figure 2.2.7.7-3). The ideal TETRA signal consists of eight points around the origin. From these, the deviations are measured to all actual points closest to each. In terms of the constellation, it is the distance from the ideal to the actual symbol. The measurement is done at the optimal symbol times and positions to exclude adverse effects of frequency error and residual carrier.

The RMS error vector magnitude for a burst is the square root of the sum of the squares of the error distances divided by the number of symbols in the burst.

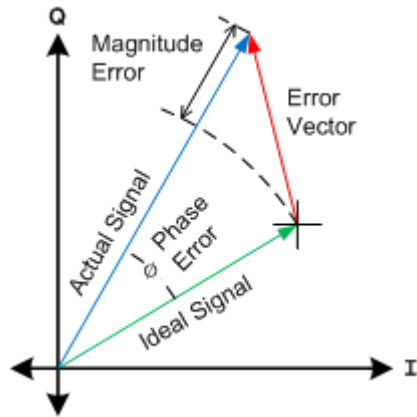

Figure 2.2.7.7-3 Error Vector Diagram

EVM (Peak)

The Peak Error Vector Magnitude for a burst is the maximum error distance found over the burst.

Unwanted Power

Unwanted Power is meant to measure the average power in non-active regions of non-active timeslots. The expected bursts to be transmitted are in every slot 1 and sometimes slot 3. Slots 2 and 4 of all frames are always non-active. The active region of a non-active slot is for ramping of an adjacent active slot. The measurement is done at the optimal symbol times and positions to exclude adverse effects of frequency error and residual carrier.

Reset Averaging (TETRA submenu)

All TETRA measurements, history, and displays are reset, including ones in other zones.

Measurement Averaging (TETRA submenu)

This key configures measurement averaging to smooth selective readings. The number of samples used can be from one (no averaging) to 250. Samples are collected five to 17 times per second. Measurement averaging affects the following:

RF Zone – Input Level

TETRA Zone – Residual Carrier Magnitude, EVM (RMS), EVM (Peak), Unwanted Power

Unwanted Power in Slot 3 (TETRA submenu)

This key configures the Unwanted Power measurement. If “No,” the computed measurement is the average power in slots 2 and 4 only, excluding active regions for adjacent slots. If “Yes,” the compound measurement is the average power in slots 2, 3 and 4, excluding the active region(s) for slot 1.

Note: *Unwanted power could be systemic or transient in nature. Use of this switch may be used to identify its nature. The average unwanted power of a systemic source will be the same for either setting, but transients in slot 2 or 4 will decrease for “Yes” (assuming slot 3 is not active).*

Display Zone

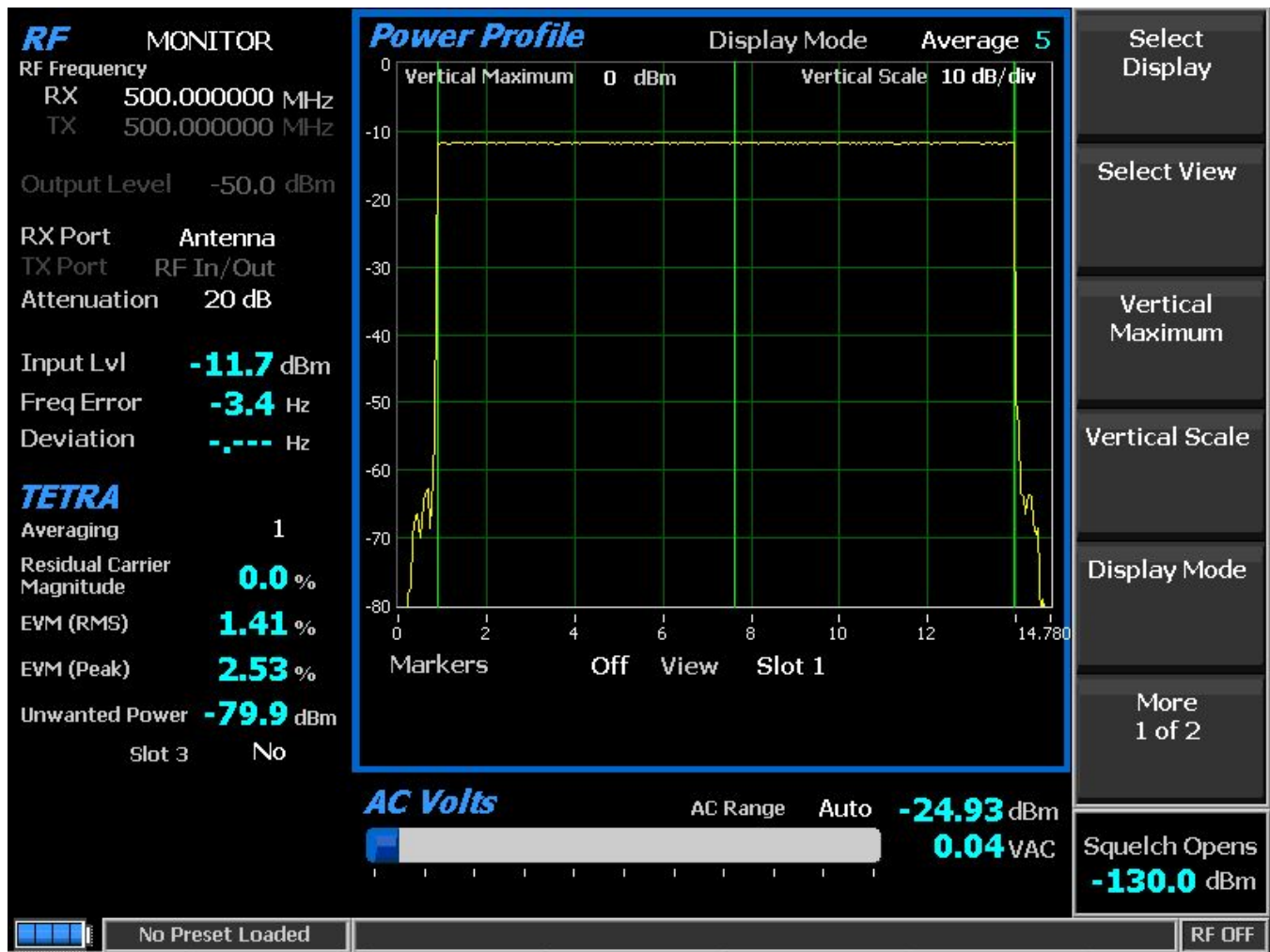

Figure 2.2.7.7-4 Power Profile Slot

Power Profile

The power profile display provides a power versus time plot of the transmitter. The display is useful in assuring that near-far situations will not result in co-channel inter-slot interference on adjacent non-transmission slots and that the power level will be adequate for acceptable BER performance. The scaling and position of the vertical power axis can be adjusted to inspect greater range or detail. The horizontal axis can be changed to view slot 1 or the frame including the additional ramp down time. Display functions and markers are available for advanced analysis. Overlays of slot centers and burst time regions are shown (see Figure 2.2.7.7-4).

Note: See the Technical Specification: ETSI EN 300 396-2 “Terrestrial Trunked Radio (TETRA); Technical requirements for Direct Mode Operation (DMO); Part 2: Radio aspects,” RF output power time mask.

Select Display (Display Zone submenu)

See 2.2.4 Display Zone for standard selections.

Select View

Select the slot(s) to view. Although slots are approximately 14.167 milliseconds (i.e. 1.02 seconds per multiframe of 18), the profile for a slot is 14.778 ms, divided into three regions for ramp-up (0.889 ms), burst (13.056 ms), and ramp-down (0.833 ms).

Slot 1 reveals a horizontal axis 0 ms to 14.78 ms with slot from 0 to 14.167 ms.

Frame reveals a horizontal axis 0 ms to 57.278 ms with four slots starting at 0 ms (see Figure 2.2.7.7-5).

Note: Ramp down time for a slot overlaps the adjacent slot by 0.611 milliseconds.

Vertical Maximum

This selection adjusts the maximum level for the vertical scale of the display (top line) from -120 dBm to +60 dBm in 1 dB increments.

Vertical Scale

This key selects the vertical scale resolution for the display's major grid lines from 1 dB/div to 10 dB/div via a horizontal soft key list.

Display Mode

This key selects the display presentation with the following horizontal menu choices:

Normal allows the display to update continuously.

Freeze provides a snapshot of the current display indication and stops additional updates.

Max Hold retains the highest peak signal amplitudes measured during successive sweeps.

Average displays signal amplitudes are a rolling average of the peak amplitudes measured on each successive sweep. The average consists of one to five sweeps, shown beside the mode indication (see Figure 2.2.7.7-4).

Marker Mode

This key provides display marker control via a horizontal soft key menu. Markers can be turned off or on with a choice of numeric readout for the signal measurements. "Absolute" provides actual peak readings while "Delta" measures the relative difference of both power and time between the markers (see Figure 2.2.7.7-5).

Toggle Marker

This selection cycles through the available markers to select the active one (yellow) for positional adjustment on the display. The active marker is moved using the Left/Right (◀▶) cursor control buttons.

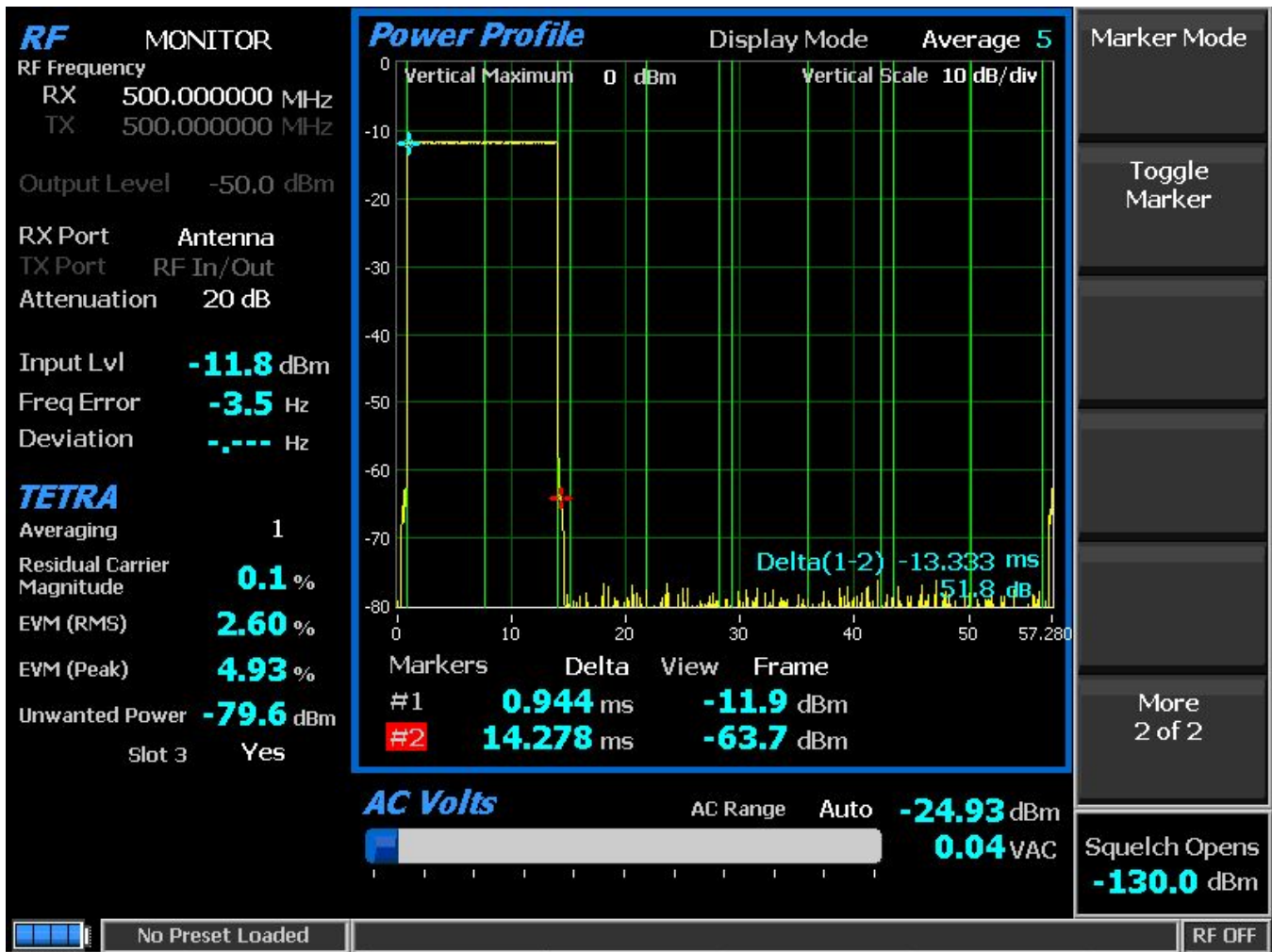

Figure 2.2.7.7-5 Power Profile Frame with Markers

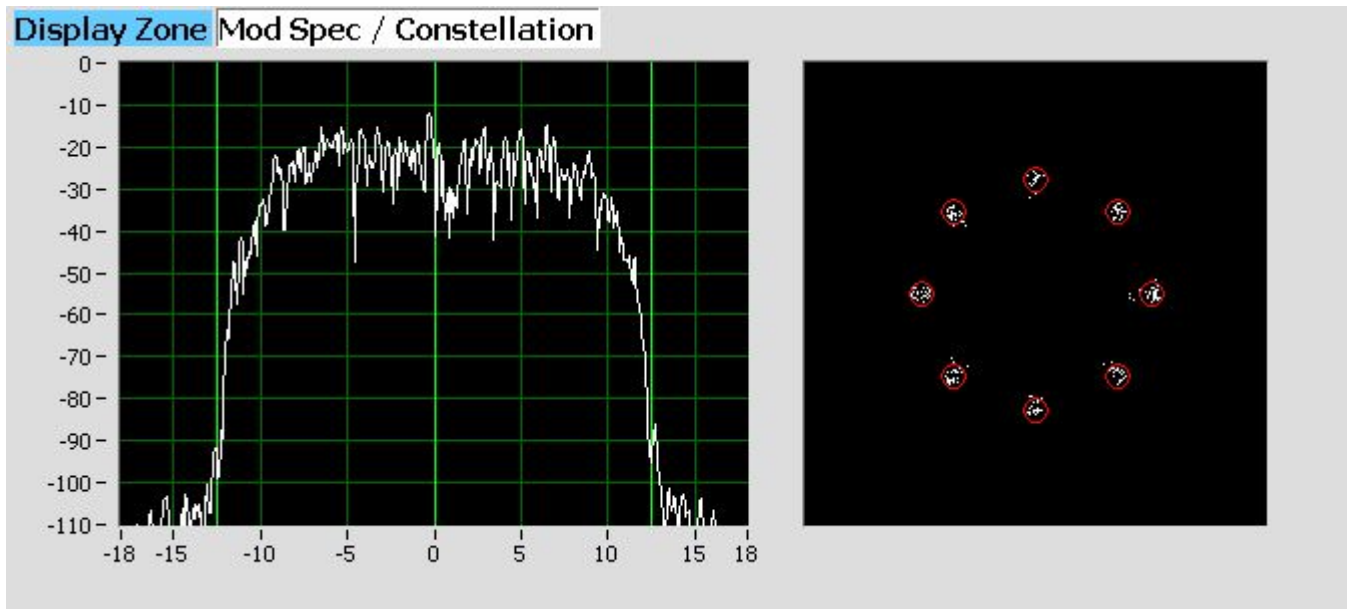

Figure 2.2.7.7-6. Mod Spec / Constellation (Symbols)

Mod Spec / Constellation

Modulation Spectrum display

This zone displays the power versus frequency (power spectral density) of the modulated symbols in the detected burst. Power is shown in dB relative to Input Level (0 dB); frequency is shown in kHz relative to Center Frequency (0 Hz). The measurement is done by over-sampling at the optimal symbol times and positions to exclude adverse effects of frequency error and residual carrier.

Constellation display

The Constellation display provides a visual representation of overall transmitter operation (see Figure 2.2.7.7-6). The constellation data represents just the data of the useful part of the burst. The measurement is done at the optimal symbol times and positions to exclude adverse effects of frequency error and residual carrier.

TETRA radios broadcast voice and data using four differential phase shift deviations from the carrier to represent symbols containing two data bits. One of four phase shifts relative to the carrier's current phase yields eight phase points. The phase trajectory never passes through the origin, ensuring that signal amplitude never falls to zero during data transmissions (see Figure 2.2.7.7-7). The center of the eight red circles on the display represent the expected locations for the deviation states when the radio is transmitting data bit symbols using the modulation. White dots show the actual deviation measurement at symbol decision times. A tighter grouping within the red circles indicates more accurate transmitter performance. The radius of the circles is the 10% EVM (Peak) limit.

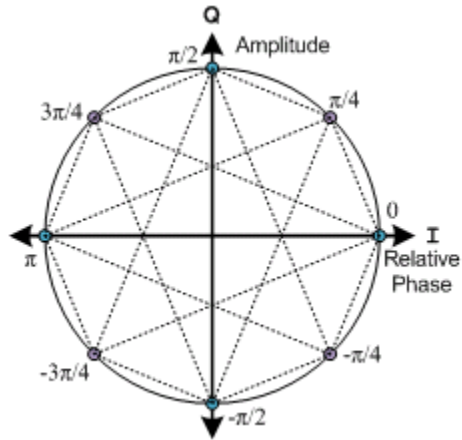

Figure 2.2.7.7-7 Ideal Constellation

Constellation Display Mode

This mode selects the display presentation with the following horizontal menu choices:

Symbols display only the samples at the optimal symbol decision times as white dots. Correct transmitter operation should group them tightly around the eight ideal phase point (see Figure 2.2.7.7-6).

Samples between symbol times three times their number are displayed as blue dots (see Figure 2.2.7.7-8).

Trajectories display blue lines connected to adjacent samples to approximate the continuous transmitter output throughout the burst (see Figure 2.2.7.7-8).

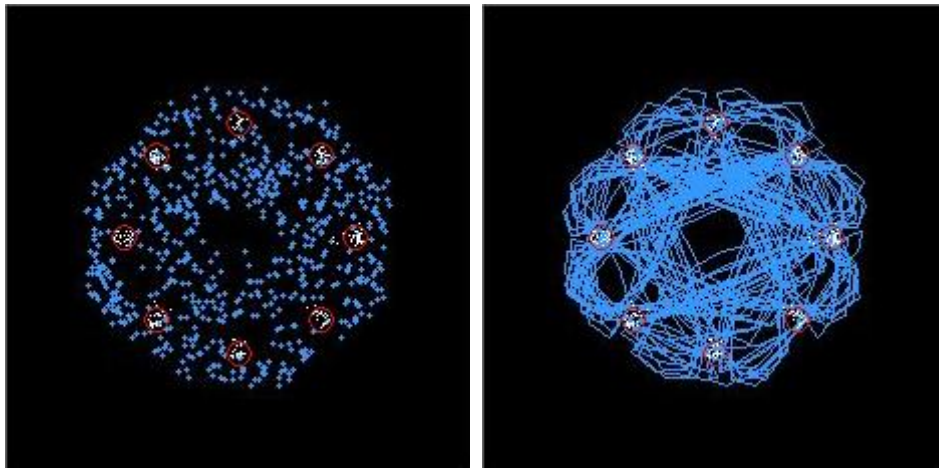

Figure 2.2.7.7-8 Constellation (Samples / Trajectories)

2.2.7.7.1.3 Meter Zone

See 2.2.5 Meter Zone for standard selections.

2.2.7.7.2 TETRA receiver tests

TETRA receiver tests are performed with the R8100 in Generate Mode, and protocol-specific tests are accessed with the TETRA soft key (see Figure 2.2.7.7-9). The R8100 generates TETRA compliant test

patterns and can be adjusted over a wide range of RF levels to determine the sensitivity and data transmission integrity of the TETRA radio. TETRA submenu selections are as follows:

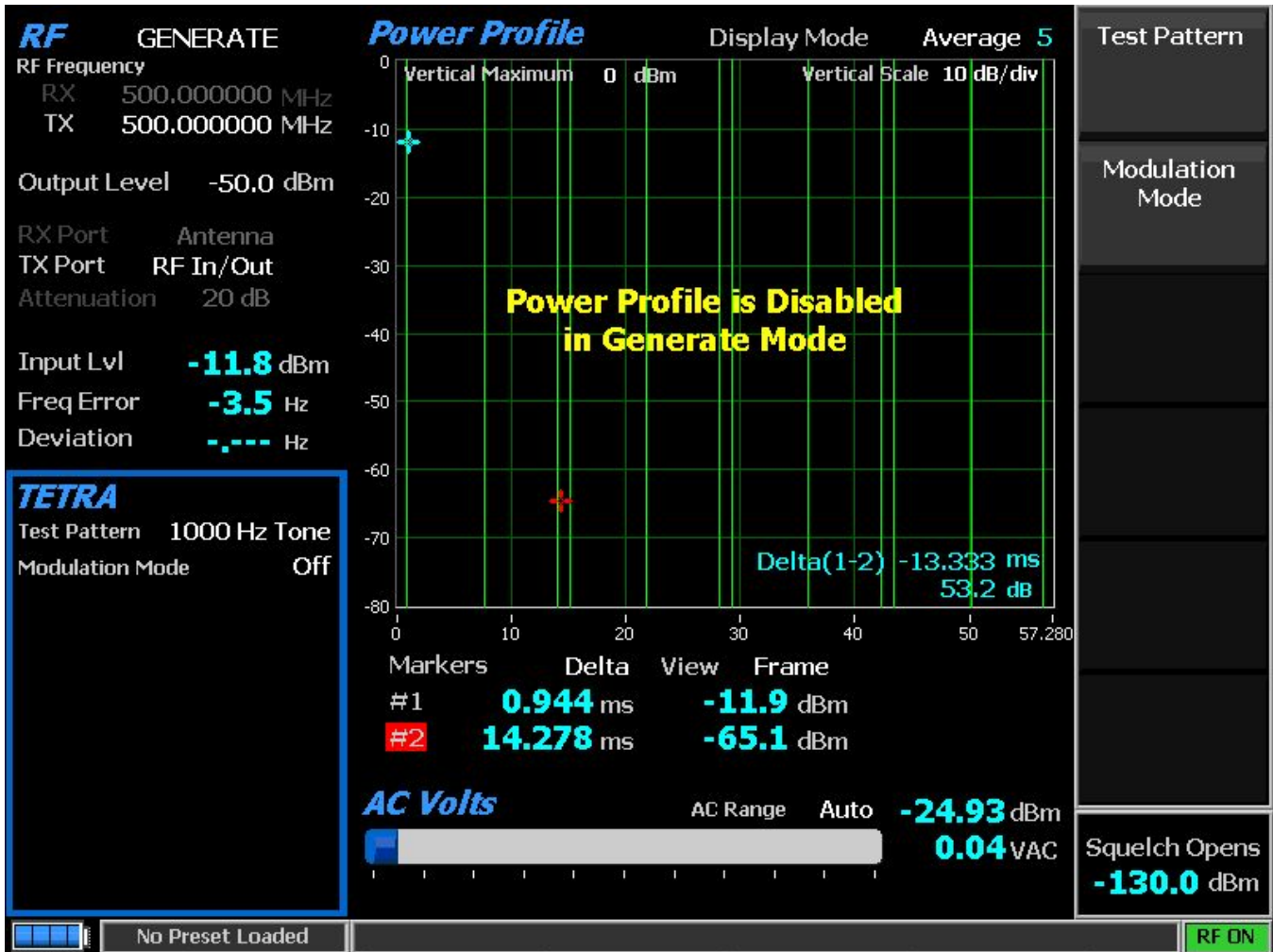

Figure 2.2.7.7-9 Submenu after pressing TETRA soft key in Generate Mode

2.2.7.7.2.1 RF Zone

Output Level

Output Level sets the average power level of the modulated Test Pattern or the level of the unmodulated carrier if Modulation Mode is Off. The upper limit is reduced by 6 dB to accommodate the modulation's peak amplitude changes.

Note: For other standard RF Zone settings, see RF Zone / Generate Mode.

2.2.7.7.2.2 TETRA Zone

Modulation Mode

This key provides a horizontal submenu with Off or Continuous for the selected Test Pattern modulation.

Test Pattern

This selection specifies the TETRA compliant test pattern generated by the R8100 to assess audio performance. Audio patterns utilize digital vocoder type ACELP at a 7.2 kHz talk channel rate. For sensitivity tests, the R8100 can transmit the multiframe test pattern over its entire output power level range. This provides an estimate of the reference sensitivity for the radio. A horizontal submenu provides the following TETRA compliant patterns:

1000 Hz Tone provides a predefined TETRA-compatible vocoder multiframe test pattern that produces a 1 kHz tone at the speaker of the receiver vocoder. It can be used to quickly check audio performance in the field.

Silence provides a predefined TETRA-compatible vocoder multiframe test pattern that results in silence at the vocoder.

Note: *All patterns use the Open TSI (O-TSI) destination (Open MNI and Open SSI) as a convenience to eliminate the need to reprogram the radio's talkgroup/ID.*

2.2.7.8 DPMR Test Mode

The R8100 dPMR Test Package option / dPMR Test Mode allows testing of radios compliant with the dPMR radio transmission protocol. dPMR radios use a digital transmission format employing Four-Level Frequency Shift Keying (4FSK) modulation in an RF spectrum managed by Frequency Division Multiple Access (FDMA) technology. It only supports a 4800 bps transmission rate. The R8100 dPMR Mode provides a grouping of test functions compliant with the Conformance Test section of the dPMR Common Air Interface (CAI) standard. These include power, Frequency Error, Symbol Deviation, Modulation Fidelity (FSK Error), audio/test patterns, and Bit Error Rate (BER). BER tests require the manufacturer's Radio Service Software (RSS) to place the radio in a special test mode. In addition, an Eye Diagram with graphical representation of the dPMR signal exists as well as a Voice Loopback function that enables the Voice Loop feature (U.S. patent 5703479) for audio verification of the radio's end-to-end operation. Both provide qualitative indication of the radio's performance. Averaging can be applied to some measurements by the System Settings. Figure 2.2.7.8-1 shows the R8100 main screen after choosing the dPMR Test Mode in Monitor Mode.

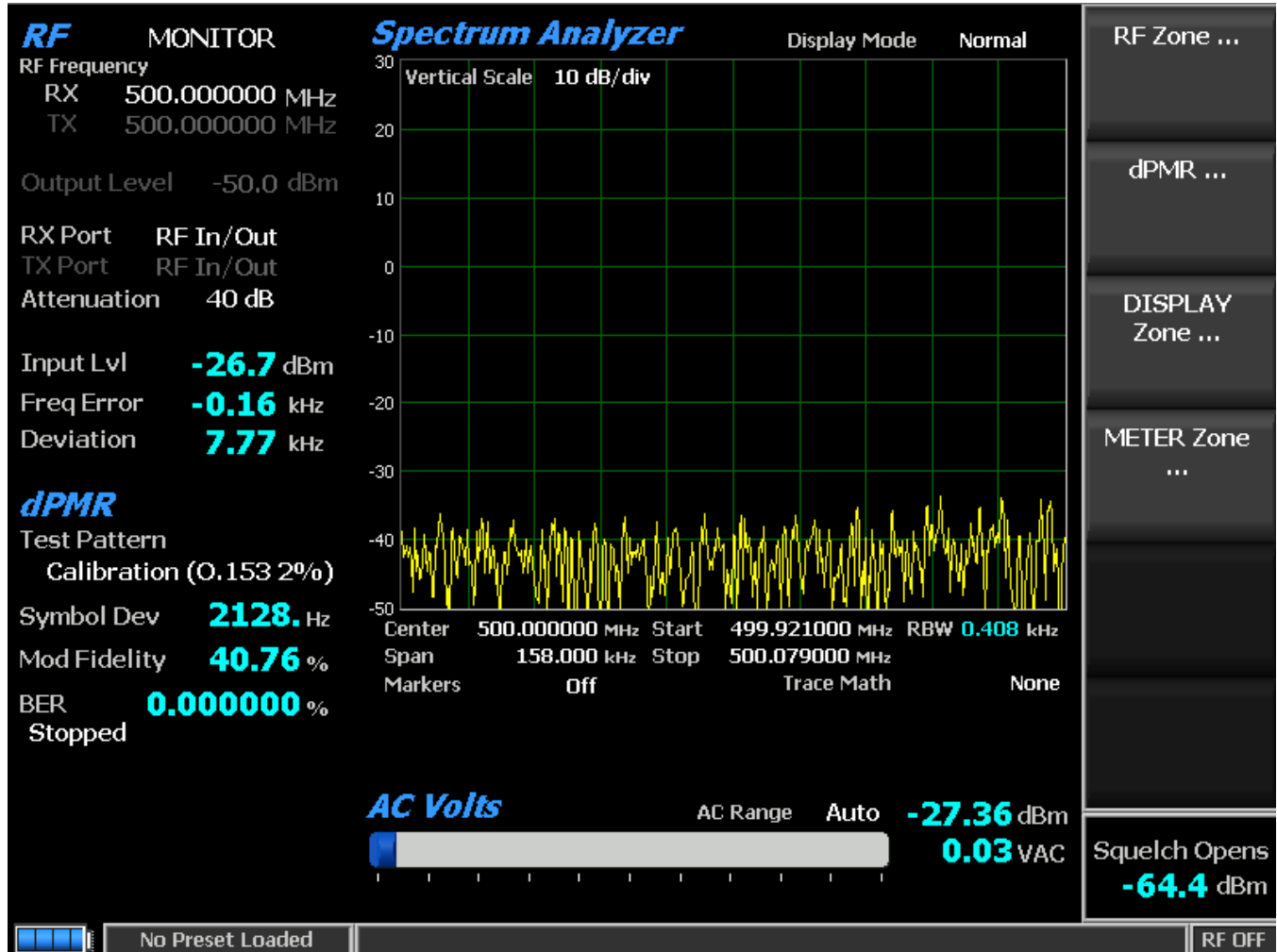

Figure 2.2.7.8-1 Main screen in Monitor Mode after selecting dPMR Test Mode

2.2.7.8.1 DPMR transmitter tests

The entire suite of dPMR transmitter tests is available in R8100 Monitor Mode after the dPMR soft key is pressed (see Figure 2.2.7.8-2). During radio transmission, the R8100 continuously measures the quality of the transmitted 4FSK signal. Numerical results are displayed as Symbol Deviation and Modulation Fidelity in the dPMR Zone. When the Eye Diagram is selected in the Display Zone, the R8100 overlays the modulation response during two symbol periods over four “target” crossing points for an ideal dPMR signal. BER tests require use of the manufacturer’s RSS to place the radio in a special test mode.

2.2.7.8.1.1 RF Zone

Input Level (RF Zone display)

Input Lvl displays the average power in the dPMR channel under test.

Note: When the RF input power on the RF In/Out port is above +20 dBm (100 mW), the R8100 utilizes a broadband power detector for the measurement. The “Input Lvl” field in the RF Zone changes to “Watt Meter” to indicate this measurement mode. For best accuracy disable the Pre-amplifier in Monitor Mode, and set the Gen Port in Generate Mode to RF In/Out.

Freq Error (RF Zone display)

Freq Error displays the frequency difference of the received dPMR transmission carrier minus the R8100 Monitor Frequency.

Deviation (RF Zone display)

Deviation displays the positive peak FM frequency deviation of the received modulated carrier (i.e. from the Frequency Error mean). See negative peak frequency deviation with Display Zone Bar Graphs.

2.2.7.8.1.2 DPMR Zone

Symbol Deviation (DPMR Zone display)

dPMR radios broadcast voice and data using a four level frequency deviation of the carrier to represent symbols containing data bits as shown in the table below. The nominal symbol deviation value for a dPMR radio using 4FSK modulation is 1050 Hz in a 6.25kHz channel. Since the deviation of a dPMR 4FSK signal is data dependent, that aspect is factored when measuring overall carrier deviation. The Symbol Deviation field provides the deviation measurement at symbol decision times.

Bits	Symbol	Deviation
01	+3	+1050 Hz
00	+1	+350 Hz
10	-1	-350 Hz
11	-3	-1050 Hz

Table 2.2.7.8.1.2-1 dPMR Symbols

Modulation Fidelity (DPMR Zone display)

Modulation Fidelity (FSK error) represents how accurate a transmitter reproduces an ideal theoretical modulation waveform. The measurement is performed by first removing frequency error and symbol deviation gain error from the received signal, then computing the RMS difference between the deviation

of the resulting signal at each symbol decision point and the ideal deviations of those symbols; no bit errors should exist. On the R8100, this is reported as an RMS error in % relative to the mean deviation across symbols.

BER (DPMR Zone display)

See BER Test.

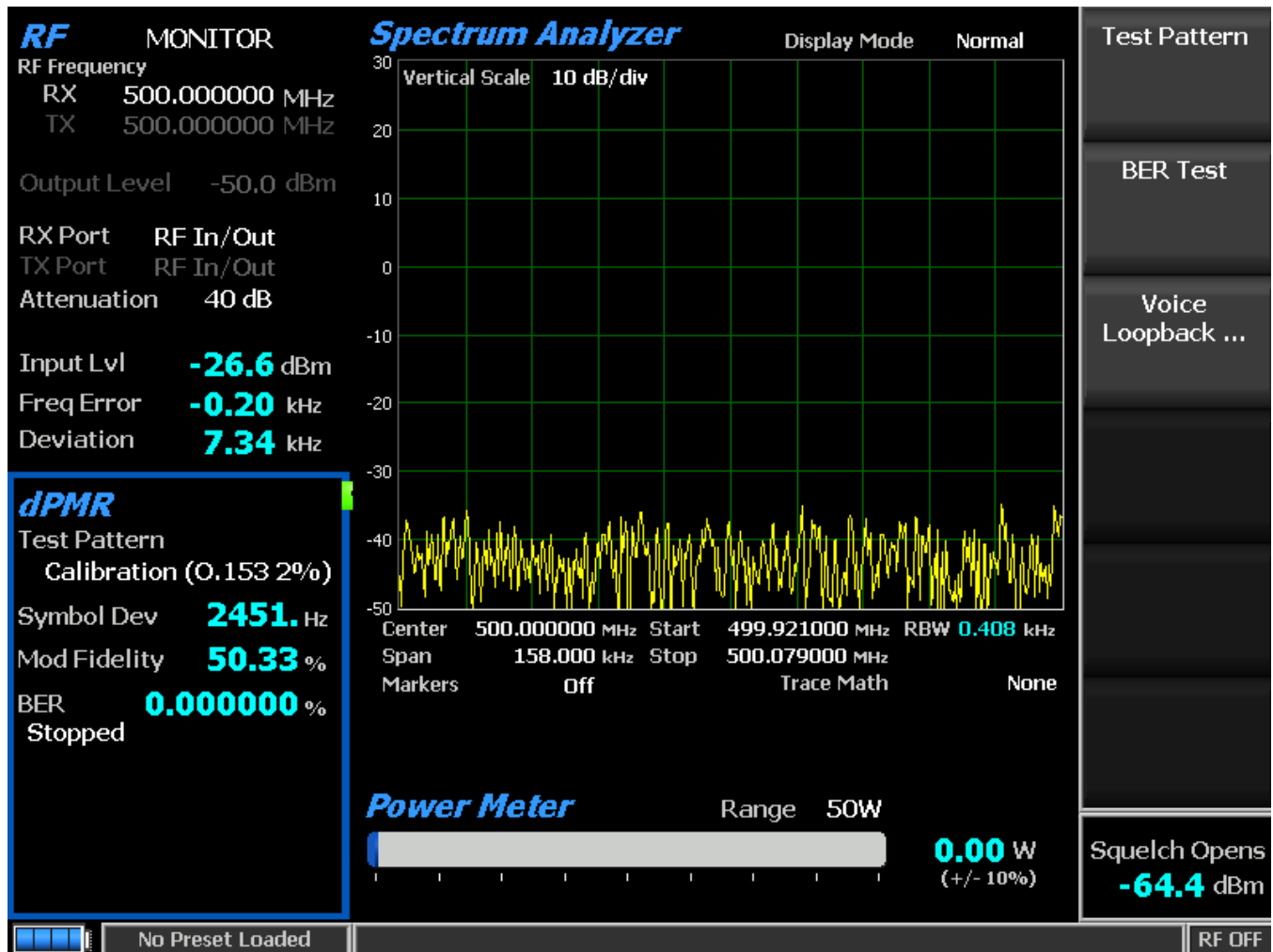

Figure 2.2.7.8-2 dPMR Monitor Mode

Monitor Test Pattern (DPMR submenu)

This mode provides selection of bit patterns for testing the radio in Transmit Mode while under RSS control. The following patterns are available:

1031 Hz Tone is the framed test pattern of the 1031 Hz half-rate vocoder tone (dPMR CAI compliant).

Calibration (O.153 2%) is a test pattern derived from the 511 (O.153) pattern to yield a 2.005871% BER used to verify BER measurements are operating correctly.

511 (O.153) is the unframed test pattern of continuously repeating 511-bit pseudo random number sequences generated with a nine-bit shift register (PN9) based on ITU-T O.153 (formerly CCITT V.52) used to perform BER testing for checking the modulation, encoding, and timing of the transmit signal (dPMR CAI compliant).

BER Test (DPMR submenu)

This selection can Start or Stop Bit Error Rate (BER) testing in the dPMR Mode of the R8100. This bit error rate test checks the modulation, encoding, and timing of the transmit signal during the data transmission period. When performing the BER Test, the radio transmitter under test must be placed into a test diagnostic mode with the correct TX test pattern selected using the manufacturer's Radio Service Software (RSS). The test is done at nominal power with the radio transmitting the test pattern into the service monitor. (It is acceptable to have an attenuator between the radio under test and the service monitor.) BER test results, the percentage of bit differences between the bits of the selected Test Pattern and the bits from the received synchronized FDMA signal, are shown in the dPMR Zone in the BER field.

Voice Loopback (DPMR submenu)

This menu selection enables the Voice Loopback feature in dPMR Mode (U.S. patent 5703479). Once enabled the R8100 automatically records voice channel data when the radio under test transmits a signal above the squelch level setting. A green Voice Playback Active indicator appears in the Test Mode Zone when Voice Loopback is enabled on the Voice Loopback screen. The Record Duration setting determines the maximum length of the recording, and a bar graph meter shows the recording's progress (see Figure 2.2.7.8-3). The recording continues if the transmission is longer than the duration, but only the most recent is retained. When the radio is un-keyed, the R8100 automatically switches to Generate Mode and transmits the captured voice channel information or speech back to the radio. This provides a quick end-to-end test of the dPMR radio transmitter and receiver.

Voice channel recordings can be played back at any time by pressing the Play Last Recording soft key (this selection only appears after a recording has been made). **Note:** *Recorded information is lost if the R8100 is power cycled or if the Generate Mode is selected and a new test pattern is enabled by setting the modulation mode to Continuous or Burst.*



Figure 2.2.7.8-3 dPMR Voice Recording

Play Last Recording (Voice Loopback submenu)

This selection appears only after a recording has been made. Pressing the soft key places the R8100 in Generate Mode and modulates the carrier with the most recently recorded voice channel data after the Voice Loopback function is enabled. The total transmission time is equal to the length of recorded data, and a bar graph indicates the remaining transmission time during playback. Speech recorded from a transmitting dPMR radio under test should be heard from its receiver if the radio is operating properly.

Record Duration (Voice Loopback submenu)

This selection sets the maximum length of a recording. The time can be varied from one to 10 seconds in a data entry window using the arrow keys, keypad, or spin knob. If the transmission is longer than this time, only the most recent is retained.

2.2.7.8.1.3 Display Zone

Select Display (Display Zone submenu)

See 2.2.4 Display Zone for standard selections, and see below for custom selections.

Eye Diagram (Display Zone selection)

The Eye Diagram provides a visual display of the received dPMR signal and overlays the modulation response during two symbol periods over the four “target” crossing points for an ideal dPMR signal (see Figure 2.2.7.8-4). Navigate to the Display Zone while in dPMR Mode to select the Eye Diagram for viewing with the other dPMR measurements on the main screen. The Eye Diagram can indicate whether a transmitter has significant unbalances or offsets in the modulation circuitry by noting how tightly grouped the waveform is around the crossing points.

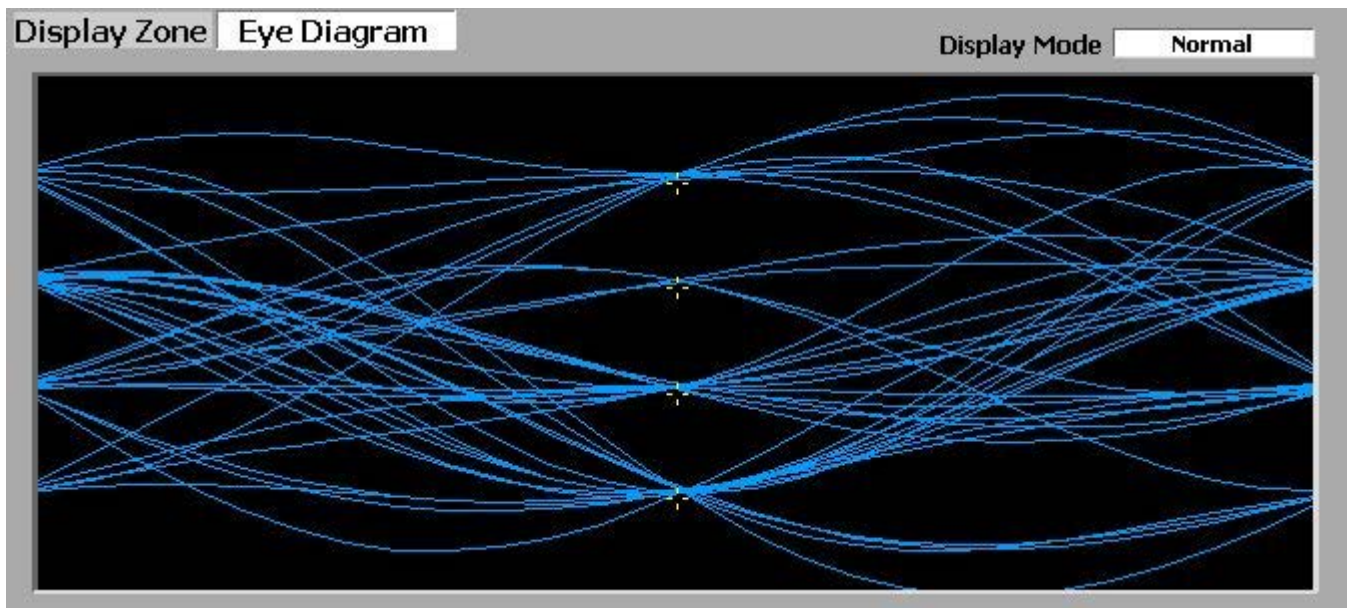

Figure 2.2.7.8-4 dPMR Eye Diagram in Display Zone

Display Mode (Eye Diagram submenu in Display Zone)

This selection provides the display presentation with the following horizontal menu choices:

Normal allows the display to update continuously.

Fade Away is similar to the Persistence Mode on an oscilloscope (see Figure 2.2.7.8-5). The intensity of each trace fades away or decays as new traces are received. The effect is to intensify the display in the area where the waveform spends most of its time. **Note:** *Whenever the Display Mode is changed, the R8100 reconfigures the presentation. This process takes approximately 10 seconds and is complete when the new setting appears in the Display Mode field.*

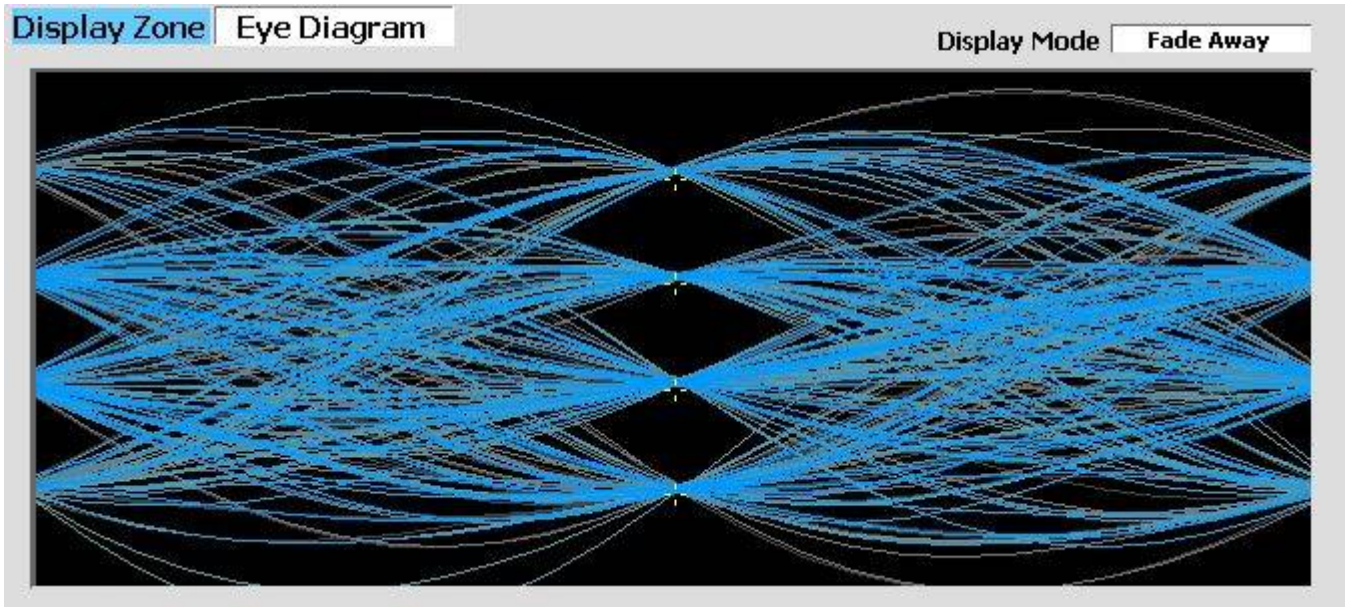

Figure 2.2.7.8-5 dPMR Eye Diagram with display in Fade Away Mode

2.2.7.8.1.4 Meter Zone

Select Meter

See 2.2.5 Meter Zone for standard selections, and see below for custom selections.

DPMR receiver tests

These tests are performed with the R8100 in Generate Mode (see Figure 2.2.7.8-6). The R8100 generates dPMR CAI compliant test patterns and can be adjusted over a wide range of RF levels to determine the sensitivity and data transmission integrity of the dPMR radio.

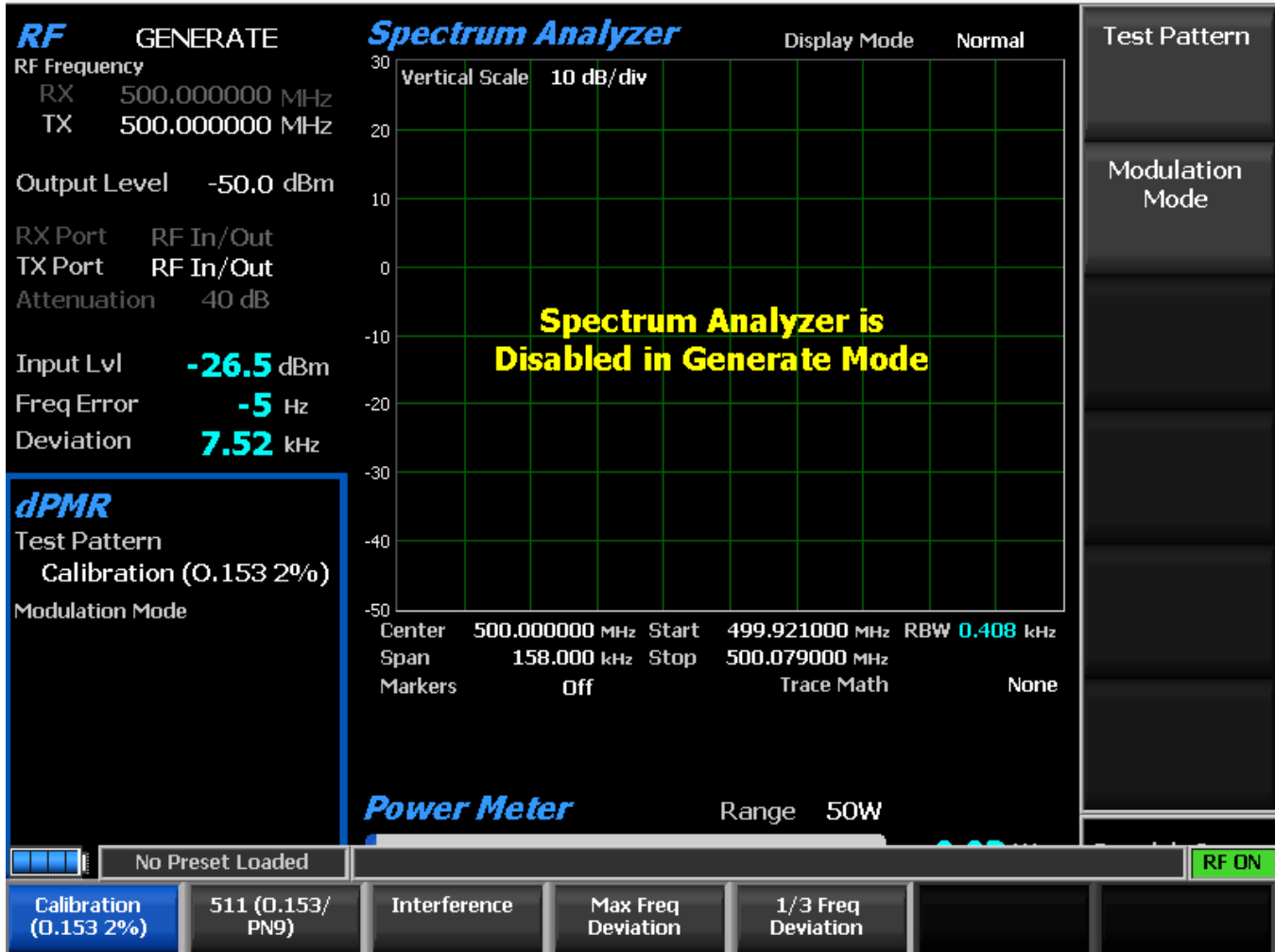

Figure 2.2.7.8-6 dPMR Generate Mode

Generate Test Pattern (DPMR submenu)

This submenu provides selection of bit patterns for testing the radio in Receive Mode. Some may require the radio to be under RSS control. The following patterns are available:

1031 Hz Tone is the framed test pattern of the 1031 Hz half-rate vocoder tone (dPMR CAI compliant).

Calibration (O.153 2%) is the test pattern derived from the 511 (O.153) pattern to yield a 2.005871% BER used to verify BER measurements are operating correctly.

511 (O.153) is the unframed test pattern of continuously repeating 511-bit pseudo random number sequences generated with a nine-bit shift register (PN9) based on ITU-T O.153 (formerly CCITT V.52) used to perform BER testing for checking the modulation, encoding, and timing of the transmit signal (dPMR CAI compliant).

Interference, Interfering Modulation Data Stream is a 32767-bit pseudo-random number pattern defined by ITU-T.

Max Freq Deviation is the maximum frequency deviation test pattern of a continuously repeating stream of high deviation symbols (+3, +3, -3, -3, ...).

1/3 Freq Deviation is the test pattern of a continuously repeating stream of low deviation symbols (+1, +1, -1, -1, ...) for a 1/3 maximum frequency deviation.

Modulation Mode (DPMR submenu)

A horizontal submenu provides choice of Off, Continuous, or Burst Mode for the selected Test Pattern modulation. **Note:** *Enabling a test pattern in Generate Mode will erase any previously captured Voice Recordings.*

Voice Playback

This selection set the state of the Voice Playback feature. When the voice playback feature is turned ON, voice traffic from the radio is recorded. At the end of the radio's transmission, the R8100 will initiate a voice call to the radio and replay the recorded audio. The feature may be turned OFF if audio playback is not desired.

2.2.7.9 P25 II Test Mode

The optional R8100 P25 II Test Mode allows testing of APCO Project 25 phase 2 compliant mobile stations (radios) and base stations (repeaters) in simplex test mode. P25 phase 2 stations use a two-slot TDMA digital transmission format and modulation schemes compliant with the TIA-102.BBAB specification. The quaternary baud rate is 6000 symbols per second.

Phase 2 radios employ Harmonized Continuous Phase Modulation (HCPM) with practically constant amplitude envelope and significant ISI for inbound traffic channels. Phase 2 repeaters employ Harmonized Differential Quadrature Phase Shift Keyed modulation (HDQPSK) with varying amplitude envelope and insignificant ISI for outbound traffic channels. The R8100 provides a grouping of test functions for the asymmetrical superframe structure that are compliant with the TIA-102.CCAA measurement standard. These include RF slot power, power envelope/timing, symbol rate, symbol deviation, modulation fidelity, frequency error, frequency deviation, bit error rate (BER), and test pattern generator. In addition, an eye diagram, distribution plot, frequency constellation, and power profile with graphical representations of signals all exist.

The 180-symbol TDMA slots (0 and 1) form a 60 ms frame, six frames form a 360 ms superframe, and four superframes form a 1.44 second ultraframe. Two logical channels (LCH0 and LCH1) are allocated in the physical slots (1st | 2nd) in an asymmetrical superframe for use in all over-the-air communications as illustrated in the table below. An inbound slot is used only if its logical channel is active; the unused slot may be called a null slot because it does not contain transmitter power. However, both outbound slots are transmitted even if neither logical channel is active. Testing of both logical channels is supported by the R8100.

Frame	1	2	3	4	5	6
Outbound LCHn	0 1	0 1	0 1	0 1	0 1	1 0
Inbound LCHn	1 0	1 0	1 0	1 0	1 0	0 1

Table 2.2.7.8.1.4-1 P25 Phase 2 Logical Channels

The manufacturer’s Radio Service Software (RSS) is required to perform some tests because certain measurements (e.g. BER, symbol rate) require placing the radio in a special test mode. Although TIA measurement methods assume that the transceiver is in Test Mode, most R8100 test functions will work with a live signal. Averaging can be applied to some measurements by the System Settings. Figure 2.2.7.9.1-1 shows the R8100 main screen after choosing the P25 II Test Mode in Monitor Mode.

2.2.7.9.1 P25 phase 2 transmitter tests

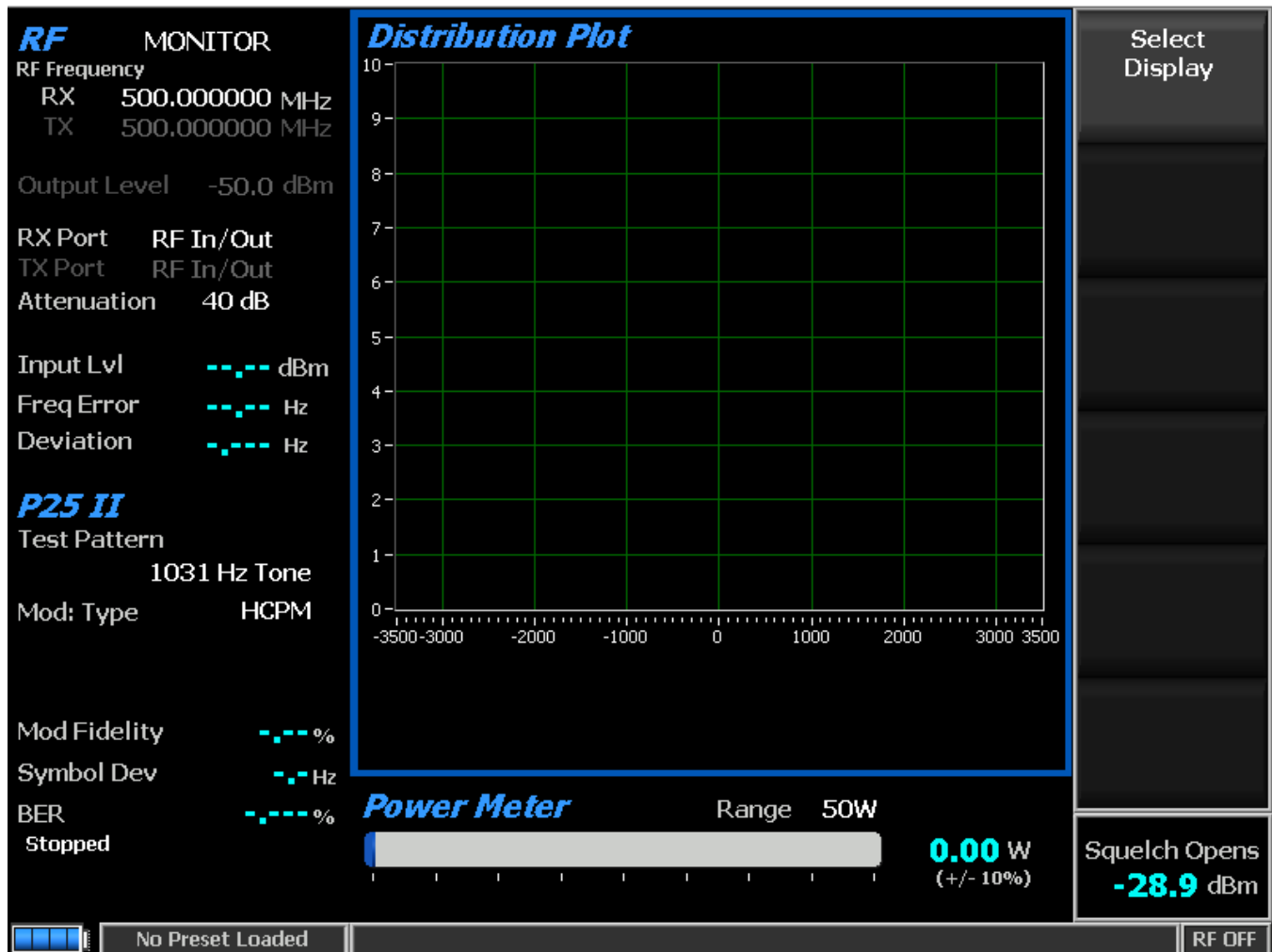

Figure 2.2.7.9.1-1 Main screen in Monitor Mode after selecting the P25 II Test Mode

Transmitter tests are performed with the R8100 in Monitor Mode and protocol-specific tests are accessed with the P25 II soft key (see Figure 2.2.7.9.1-1). The R8100 searches for the synchronization pattern and then continuously measures the quality of the radio's transmitted signal as long as the R8100 is synchronized to it. The logical channel to analyze defaults to LCH0 but switches to LCH1 if LCH0 is null. For Bit Error Rate (BER) testing, the manufacturer's RSS software is required. This configures the radio in a special test mode for transmitting TIA-102.CCAA compliant test patterns such as 1031 Hz Tone, Calibration, Silence, Interference, and Low and High deviation patterns.

The test patterns provided in the R8100 may be classified into two groups depending on the modulation type. Each modulation type (HCPM/HDQPSK) has a corresponding tone, calibration, and silent test pattern that contains the applicable symbol data in the appropriate inbound/outbound TDMA frame format. The high deviation, low deviation, and interference test patterns are unframed and common to both modulation schemes.

The tests performed are as follows:

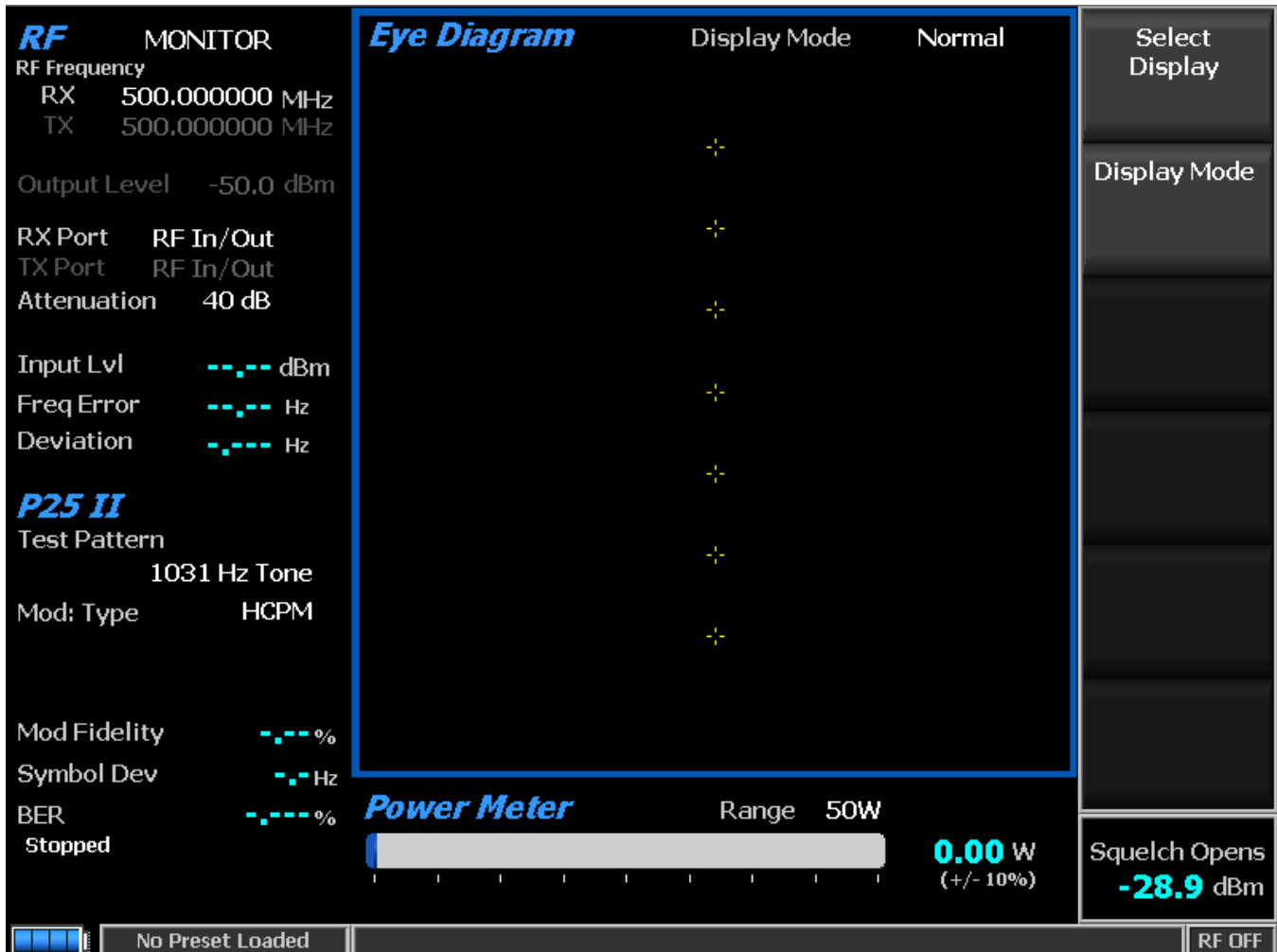

Figure 2.2.7.9.1-2 Main screen in Monitor Mode after pressing the P25 II soft key

2.2.7.9.1.1 RF Zone

Input Level (RF Zone display)

Input Lvl displays the average power in the logical channel under test.

Note: When the RF input power on the RF In/Out port is above +20 dBm (100 mW), the R8100 utilizes a broadband power detector for the measurement. The “Input Lvl” field in the RF Zone changes to “Watt Meter” to indicate this measurement mode. For best accuracy disable the Pre-amplifier in Monitor Mode, and set the Gen Port in Generate Mode to RF In/Out.

Note: The TDMA transmission alternates between a used and unused time slot, so the RF Zone field will switch between the two. An unused slot has no power, so the display will flash between “Input Lvl” and “Watt Meter.” In this condition, the Input Level reading should be used since null slots can cause the Watt Meter indication to read approximately 3 dB less than the power in the used slots.

Freq Error (RF Zone display)

Freq Error displays the frequency difference of the received transmission carrier minus the R8100 Monitor Frequency.

Deviation (RF Zone display)

Deviation displays the positive peak frequency deviation of the received modulated carrier (i.e. from the Frequency Error mean). See negative peak frequency deviation with Display Zone Bar Graphs.

2.2.7.9.1.2 P25 II Zone

Test Pattern (P25 II submenu)

Test Pattern provides selection for one of three TIA-102.CCAA compliant predefined test patterns for BER testing of a P25 radio in Monitor Mode as shown in Figure 2.2.7.3.1.2-1. Each measurement uses an ultraframe of data. Outbound uses 10880 bits (0.009%/bit); inbound uses from 7252 to 7536 bits (~0.013%/bit) if there is no random-access SAACH to exclude. The following patterns are available:



Figure 2.2.7.9.1.2-1 Test Pattern submenu in P25 II Monitor Mode

1031 Hz Tone is the standard tone framed test pattern of the 1031 Hz vocoder tone for either modulation type and both logical channels.

Calibration (Tone 5%) is the test pattern derived from the standard 1031 Hz Tone test pattern to verify BER measurements are operating correctly for either modulation type and both logical channels. The first of every 20 bits is inverted. However, the inbound BER is 4.992% if a random-access SACCH is received or 4.989% if not (rather than 5% since some of the 20 bits are not to be included in the comparison).

Silence is the framed test pattern for silence at the vocoder for either modulation type and both logical channels.

Modulation Type (P25 II submenu)

This key select the expected type of modulation of the received signal to be analyzed: HCPM (inbound) or HDQPSK (outbound). The type specified is also used in the Display Zone to enable selection of the Power Profile for inbound frames.

Modulation Fidelity (P25 II Zone display)

Modulation Fidelity represents how accurate a P25 transmitter reproduces an ideal theoretical modulation waveform. The measurement is performed by first removing frequency error and symbol deviation gain error from the received signal, then computing the RMS difference between the deviation of the resulting signal at each symbol decision point and the ideal deviations of those symbols; no bit errors should exist. On the R8100, this is computed over a symbol interval (180 for HDQPSK; 164 for HCPM) and reported as an RMS error in % normalized across symbols.

Symbol Deviation (P25 II Zone display)

This selection displays the symbol deviation estimated by averaging the normalized frequency deviations (of the FM representation of the phase-based modulation) at symbol times in the received signal and then scaling by the maximum symbol value. The normalized frequency deviation is computed as the ratio of the actual frequency measurement at a given symbol or deviation state by the corresponding symbol value. The HCPM ideal is 2992 Hz; since symbol decisions are based on 60° phase changes, they do not correspond to four frequency deviations. The HDQPSK ideal is 2250 Hz.

Bits	Symbol	Deviation	Δ Phase
01	+3	+2250 Hz	+135°
00	+1	+750 Hz	+45°
10	-1	-750 Hz	-45°
11	-3	-2250 Hz	-135°

Table 2.2.7.9.1.2-1 HDQPSK Symbols

BER Test (P25 II submenu)

This selection starts or stops Bit Error Rate (BER) testing. When performing the BER test, the radio transmitter under test must be placed in a Test Diagnostic Mode using the manufacturer’s Radio Service Software (RSS). The transmission is compared against the Test Pattern specified in the P25 II submenu. BER test results are shown as an error in % in the P25 II Zone (see Figure 2.2.7.9.1.2-1).

BER (P25 II Zone display)

See BER Test above.

2.2.7.9.1.3 Display Zone

Select Display (Display Zone submenu)

See 2.2.4 Display Zone for standard selections, and see below for custom selections.

Eye Diagram (Display Zone selection)

The Eye Diagram provides a visual display of the received signal and overlays the modulation response during two symbol periods over the yellow “target” crossing points for an ideal signal (see Figure 2.2.7.9.1.3-1). The Eye Diagram can indicate whether a transmitter has significant unbalances or offsets in the modulation circuitry by noting how tightly grouped the waveform is around the crossing points. Be sure that the Modulation Type in the P25 II Test Zone is set for the expected receive signal in order to establish the appropriate number of crossing points and symbol timing used to position the diagram on the horizontal axis. The center of the display is at symbol times for HDQPSK but halfway between symbol times for HCPM. Some overshoot caused by ISI is expected, more for HCPM. View the Eye Diagram with the other P25 measurements on the main screen by selecting it in the Display Zone.

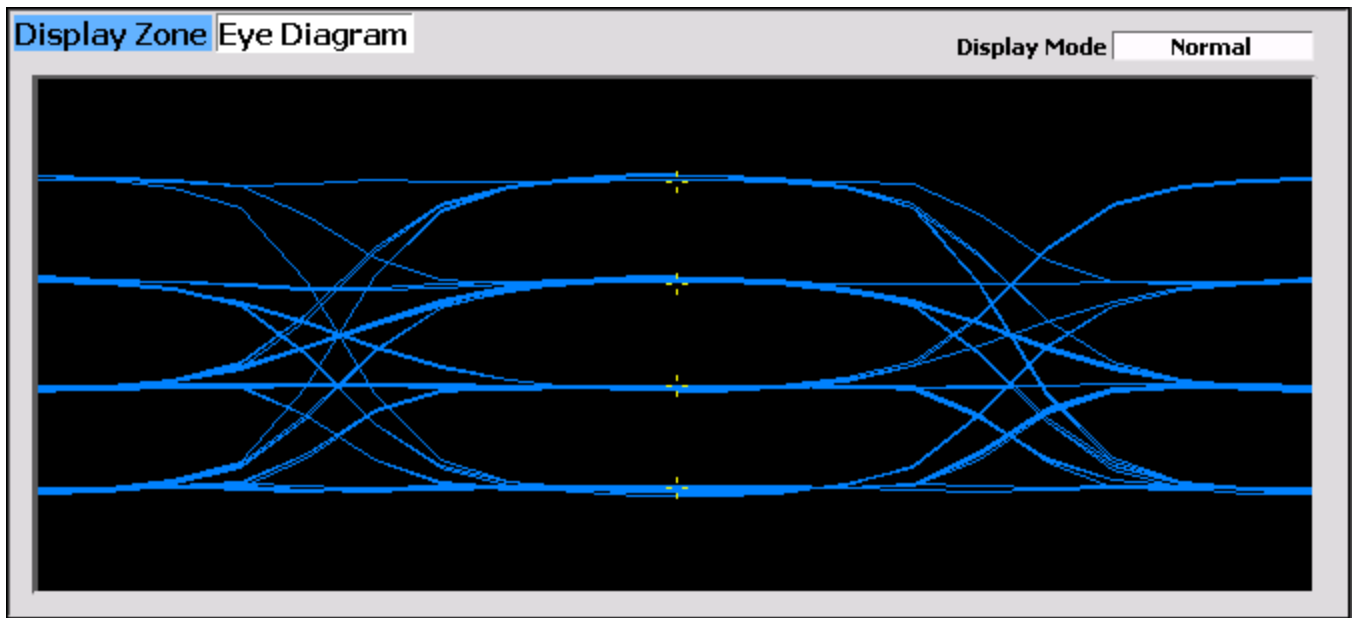

Figure 2.2.7.9.1.3-1 HDQPSK Eye Diagram selection in Display Zone

Display Mode (Eye Diagram submenu)

This key selects the display presentation with the following horizontal menu choices:

Normal indicates that the display updates continuously.

Fade Away is similar to the Persistence Mode on an oscilloscope (see Figure 2.2.7.9.1.3-2). The intensity of each trace fades away or decays as new traces are received. The effect is to intensify the display in the area where the waveform spends most of its time. **Note:** *Whenever the Display Mode is changed, the R8100 reconfigures the presentation. This process takes approximately 10 seconds and is complete when the new setting appears in the Display Mode field.*

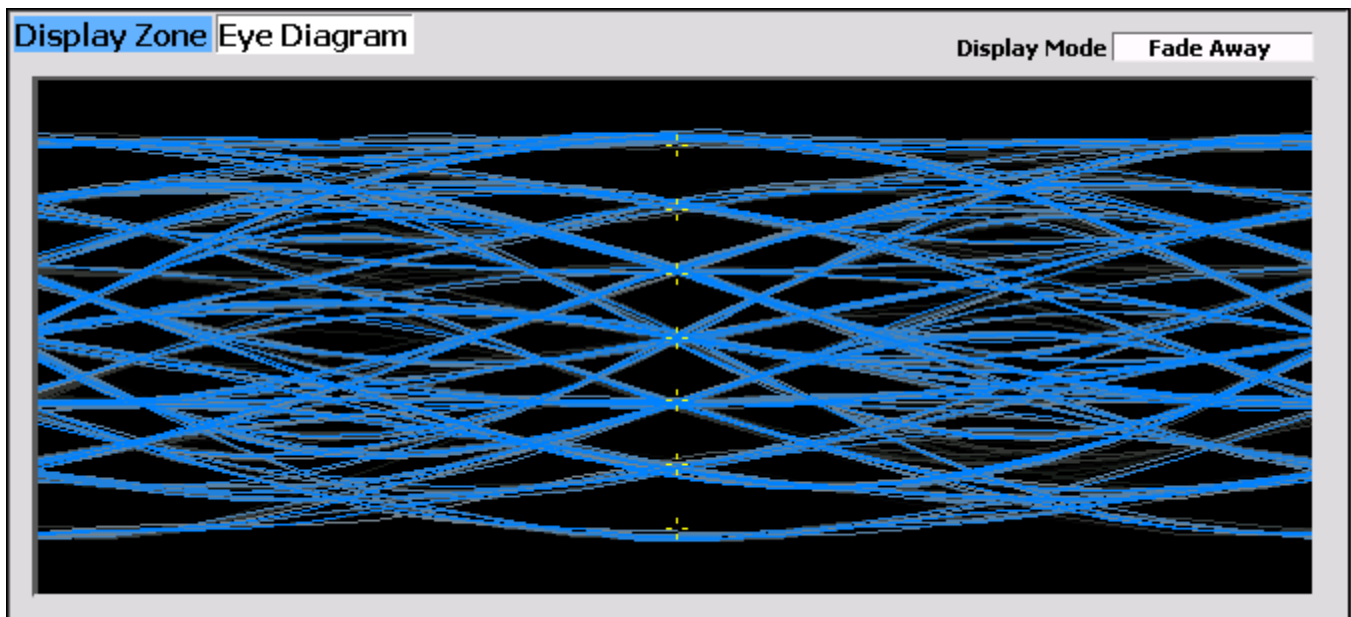

Figure 2.2.7.9.1.3-2 Eye Diagram of HCPM and Display Mode Fade Away

Distribution Plot (Display Zone selection)

This selection displays a graph showing the distribution of symbol deviations of the received signal grouped into frequency bins, i.e. the frequency offset versus the rate of occurrence of that frequency (~10 Hz for HDQPSK; ~12 Hz for HCPM). Each plot consists of about two seconds of the most current data available.

HDQPSK consists of four symbol values (-3, -1, +1, +3) at proportional carrier deviations (see Table 2.2.7.9.1.2-1). The four ideal symbol deviations are labeled at gridlines with additional gridlines half way between them, dividing the plot into four equal regions and marking the thresholds where symbol decisions change from one to the other. For example, in low power conditions, noise may cause a symbol's deviation to appear in the adjacent region, thus causing a bit error.

Be sure that the Modulation Type in the P25 II Test Zone is set for the expected receive signal in order to establish the appropriate horizontal range and symbol timing used to sample the deviation appropriately. Sampling is at symbol times for HDQPSK but halfway between symbol times for HCPM. ISI inherent in the modulations causes some overshoot exhibited by groups being further from center and having multiple peaks.

All distribution amounts are displayed by automatic adjustment of the vertical axis scaling to show the full amount of symbols falling into each bin. Distribution amounts are the percentage of the number of symbols whose deviation falls within that point's frequency bin based on the number of symbols in the analysis population. The better a signal is, the more symbols will actually land in the ideal bin to increase its percentage. Deviations that are past the graph edge limits (e.g. for noise if there is no signal) are collected and shown in the bin at the limit.

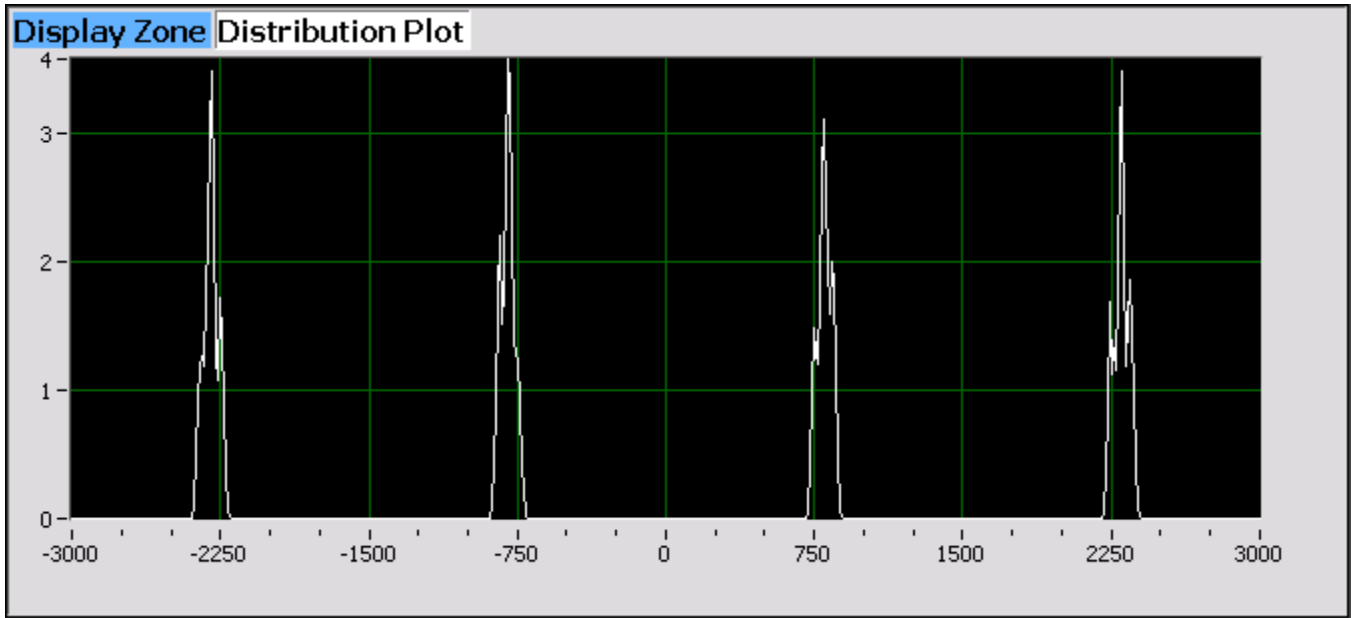

Figure 2.2.7.9.1.3-3 Distribution Plot of HDQPSK 1031 Hz Tone

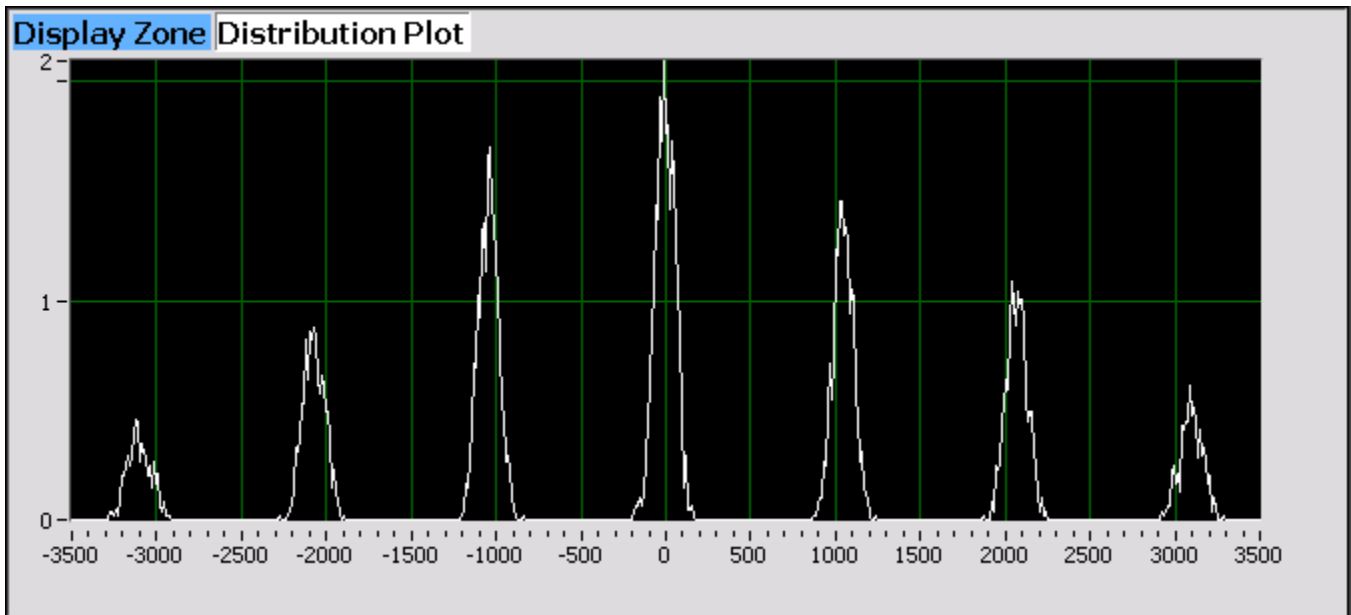

Figure 2.2.7.9.1.3-4 Distribution Plot of HCPM 1031 Hz Tone

Power Profile (Display Zone selection)

The power profile display provides a power versus time plot for an HCPM transmitter (null slots are not transmitted for HDQPSK). The display is useful in assuring that near-far situations will not result in co-channel inter-slot interference on the alternate or non-transmission slot and that the power level will be adequate for acceptable BER performance. The scaling and position of the vertical power axis can be adjusted to inspect greater range or detail. The horizontal axis can be changed to view one or both slots,

including the additional ramp up/down time. Display functions and markers are available for advanced analysis. Overlays of slot centers and burst time regions are shown (see Figure 2.2.7.9.1.3-5).

Note: See the transmitter power envelope standard: TIA-102.CCAA 2.2.17.3 TDMA Method of Measurement.

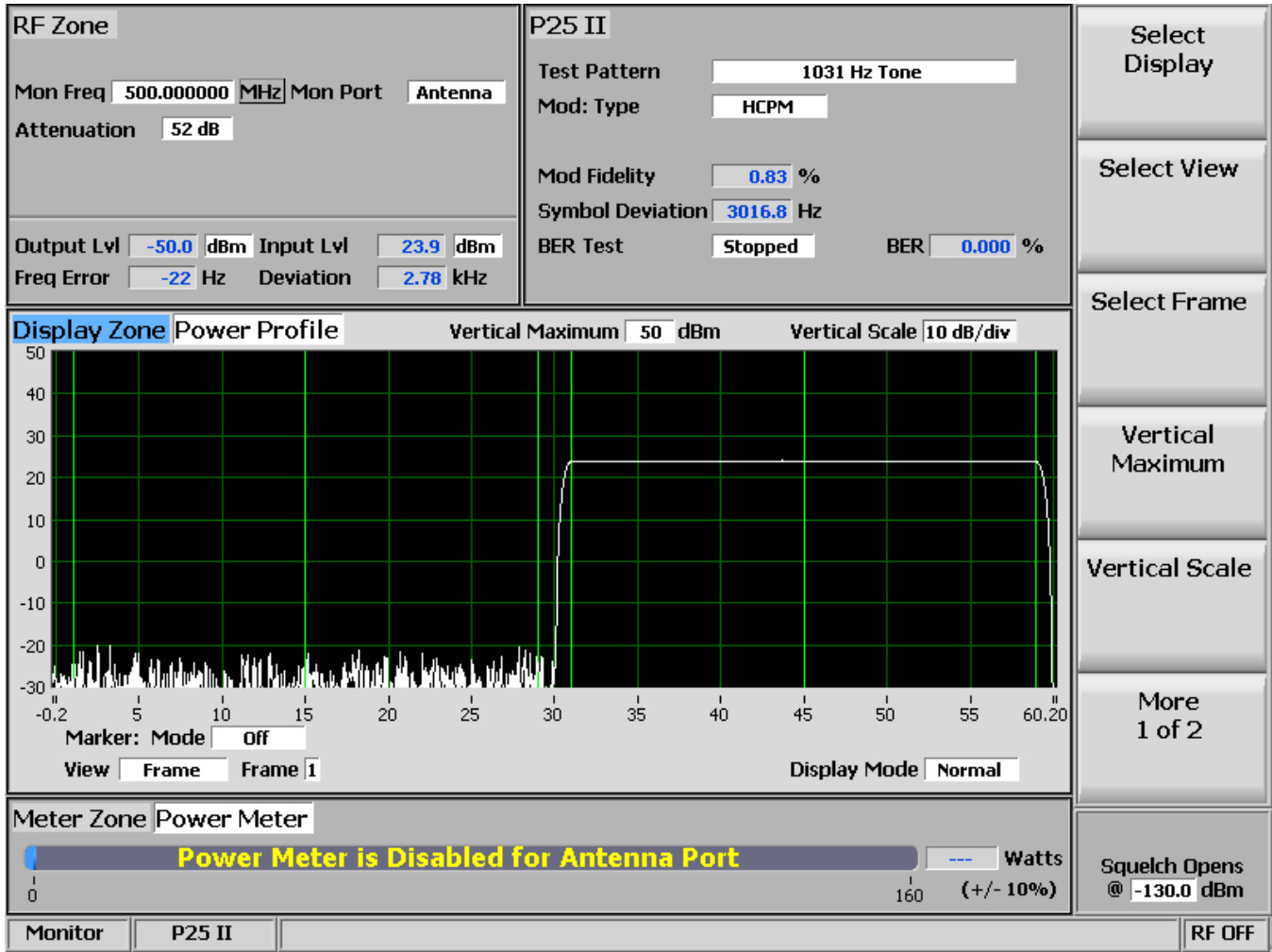

Figure 2.2.7.9.1.3-5 Power Profile Frame

Select View (Power Profile submenu)

Select the slot(s) to view. Although slots are alternating 30 milliseconds, the profile for a slot is 30.4 ms, divided into three regions for ramp-up (1.2 ms), burst (28.0 ms), and ramp-down (1.2 ms).

Frame displays the horizontal axis -0.2 ms to 60.2 ms with slots from 0 to 30 and 30 to 60 ms. See Figure 2.2.7.9.1.3-5.

Slot 1 displays the horizontal axis -0.2 ms to 30.2 ms with slot from 0 to 30 ms.

Slot 2 displays the horizontal axis 29.8 ms to 60.2 ms with slot from 30 to 60 ms.

Note: Ramp up/down times for a slot overlap the adjacent slots by 0.2 milliseconds.

Select Frame (Power Profile submenu)

Select which frame of a superframe to view. See the asymmetrical superframe structure in Table 2.2.7.8.1.4-1 P25 Phase 2 Logical Channels (Inbound).

Vertical Maximum (Power Profile submenu)

This key adjusts the maximum level for the vertical scale of the display (top line) from -120 dBm to +60 dBm in 1 dB increments.

Vertical Scale (Power Profile submenu)

This key selects the vertical scale resolution for the display's major grid lines from 1 dB/div to 10 dB/div via a horizontal soft key list.

Display Mode (Power Profile submenu)

This key selects the display presentation with the following horizontal menu choices:

Normal indicates that the display updates continuously.

Freeze provides a snapshot of the current display indication and stops additional updates.

Max Hold allows the display to retain the highest peak signal amplitudes measured during successive sweeps.

Average indicates that the displayed signal amplitudes are a rolling average of the peak amplitudes measured on each successive sweep. The average consists of one to five sweeps, shown beside the mode indication.

Marker Mode (Power Profile submenu)

This key provides display marker control via a horizontal soft key menu. Markers can be turned off or on with a choice of numeric readout for the signal measurements. "Absolute" provides actual peak readings while "Delta" measures the relative difference of both power and time between the markers (see Figure 2.2.7.9.1.3-6).

Toggle Marker (Power Profile submenu)

Toggle Marker cycles through the available markers to select the active one (yellow) for positional adjustment on the display. The active marker is moved using the Left/Right (◀▶) cursor control buttons.

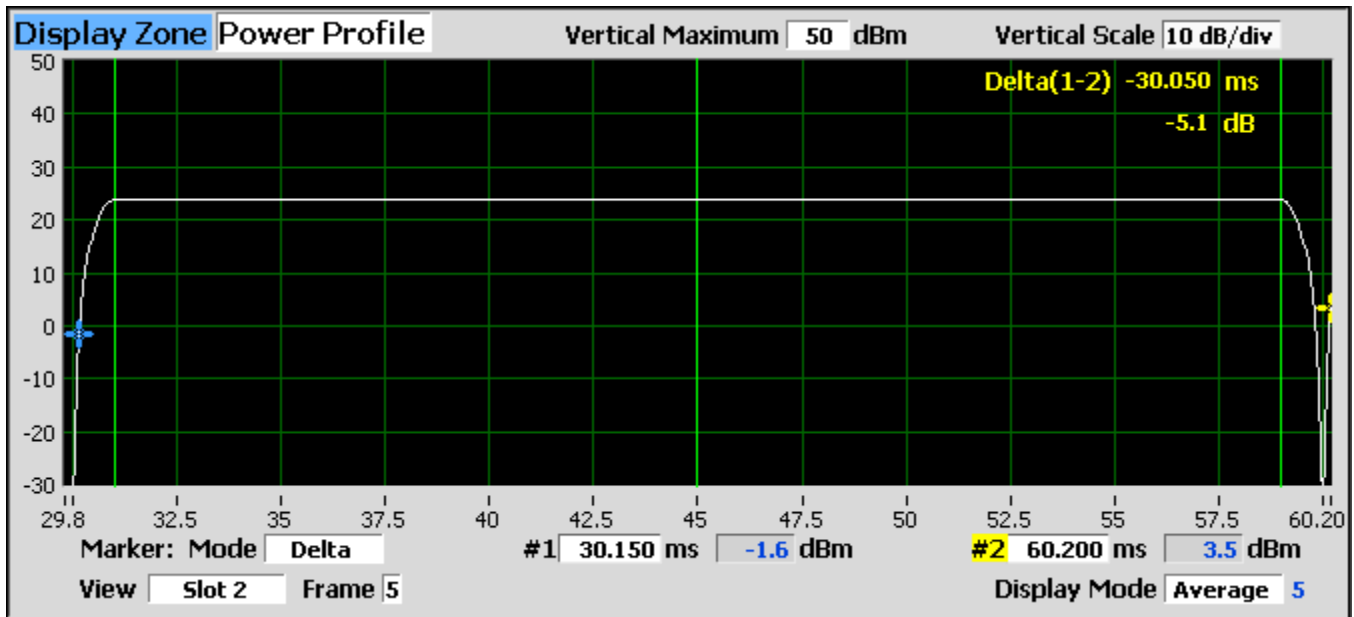

Figure 2.2.7.9.1.3-6 Power Profile Slot with Markers

2.2.7.9.1.4 Meter Zone

See 2.2.5 Meter Zone for standard selections.

Constellation (Display Zone selection)

The Constellation display provides a visual representation of overall transmitter operation. This selection displays a graph showing the distribution of symbol deviations of the received signal. Each plot consists of one slot of the most current data available. Symbols (containing two data bits) are transmitted with phase changes that can be represented as deviations of the carrier. Red tick marks on the display represent the nominal locations for the deviation states when the radio is transmitting data using the modulation. White bars show the actual deviation measurement. A tighter grouping around the red tick marks indicates more accurate transmitter performance.

The Modulation Type in the P25 II Test Zone must be set for the expected receive signal in order to establish the appropriate horizontal range and symbol timing used to sample the deviation appropriately. Sampling is at symbol times for HDQPSK but halfway between symbol times for HCPM. ISI inherent in the modulations causes some overshoot exhibited by groups being a little further from center.

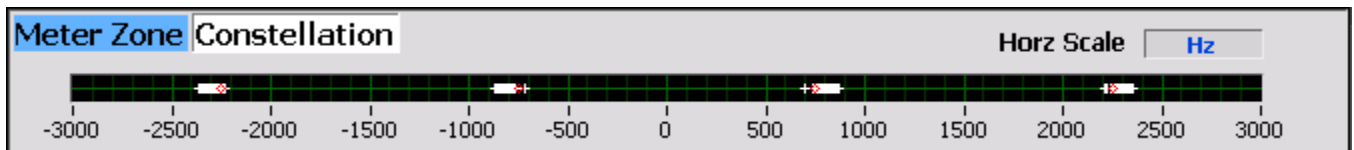

Figure 2.2.7.9.1.4-1 HDQPSK Frequency Constellation

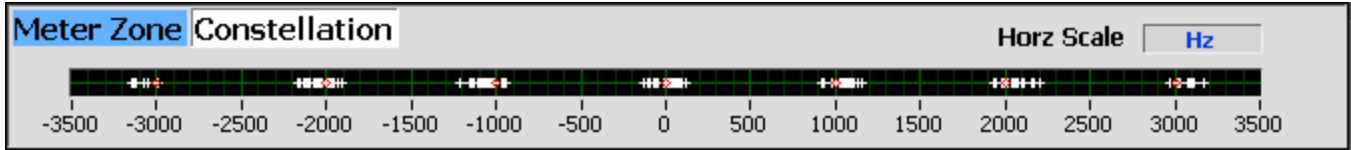

Figure 2.2.7.9.1.4-2 HCPM Frequency Constellation

Frequency Counter (Standard Test Mode Meter Zone selection)

The Frequency Counter can be used to measure the transmitter symbol rate accuracy error, the difference of the actual minus the ideal. Thus, a positive error indicates that the transmitter clock is too fast. P25 phase 2 standard TIA-102.CCAB-A 3.2.14 Symbol Rate Accuracy states that the symbol rate error shall not exceed 10 PPM, which is +/- 60 mHz given the ideal symbol rate of 6000 baud. The transmitter should be transmitting the high deviation pattern (+3,+3,-3,-3) whose frequency period is a quarter of the baud rate period. The R8100 should be configured with optimal settings (i.e. RF Zone: Modulation = FM, Bandwidth = 12.5 kHz; Audio Zone: High Pass Filter = 300 Hz, Low Pass Filter = 3 kHz). See 2.2.5.5 for an FM rate measurement. Use the following equation to compute the error: ppm error = $(\text{Frequency_Count}_{\text{Hz}}/1500 - 1) \times 10^6$, e.g. $(1500.0015/1500 - 1) \times 1000000 = 1 \text{ PPM}$.

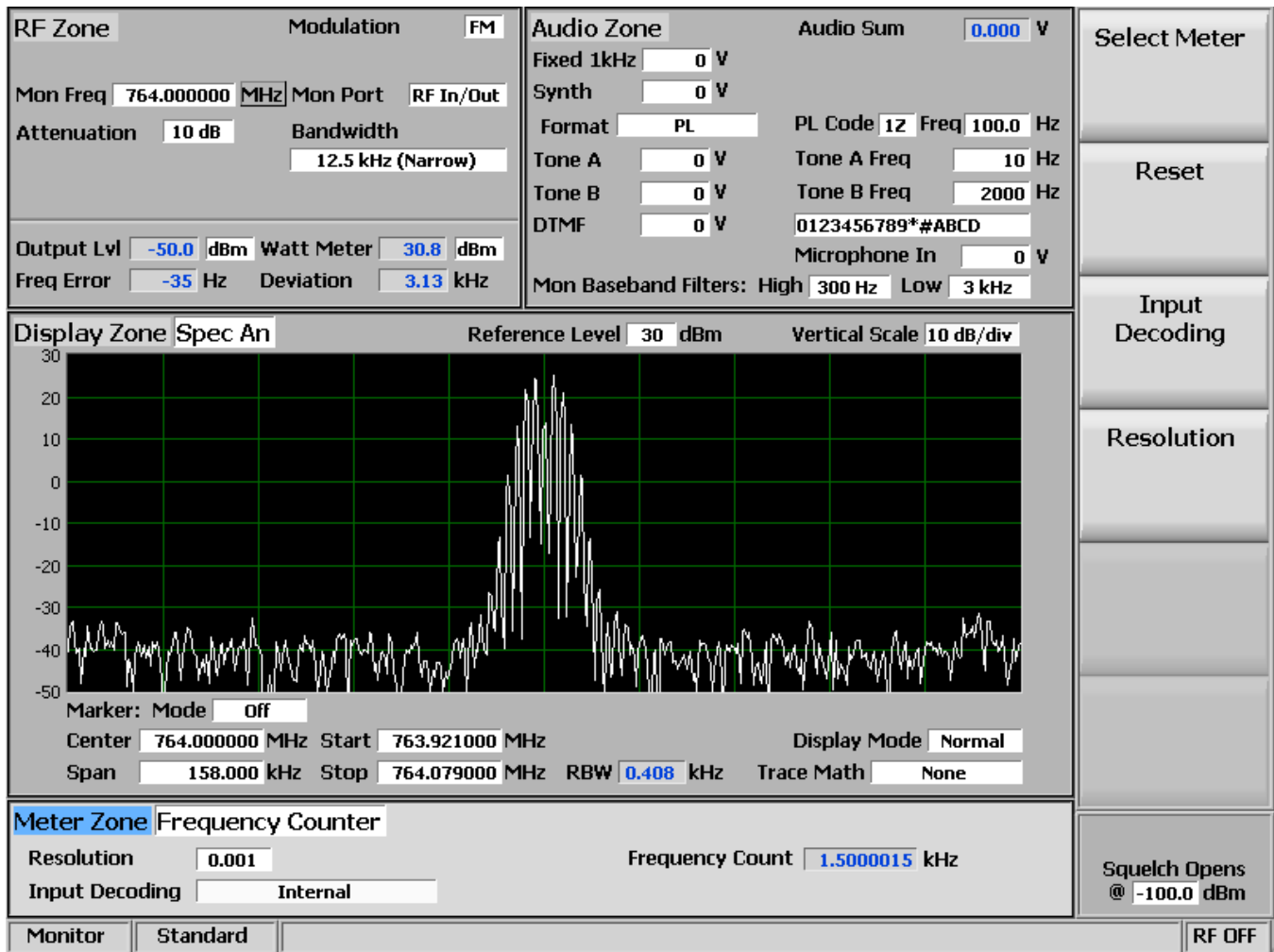

Figure 2.2.7.9.1.4-3 P25 Phase 2 Symbol Rate Measurement

2.2.7.9.2 P25 phase 2 receiver tests

P25 Phase 2 receiver tests are performed with the R8100 in Generate Mode, and protocol-specific tests are accessed with the P25 II soft key (see Figure 2.2.7.9.2-1). The R8100 can generate various P25 compliant test patterns using HDQPSK and HCPM (see Figure 2.2.7.9.2-2). They can be used in conjunction with the radio manufacturers' RSS to perform BER testing and alignment.

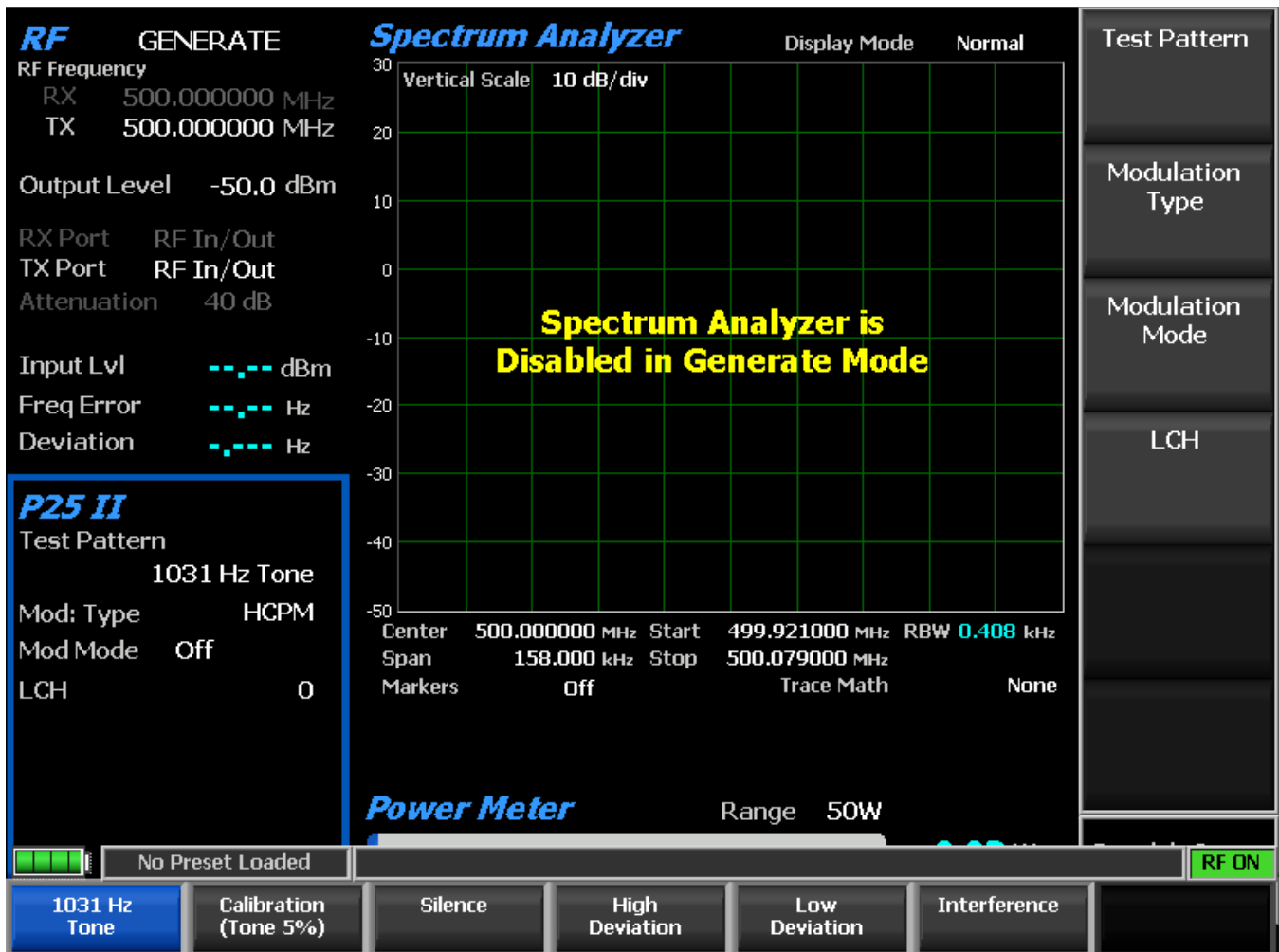

Figure 2.2.7.9.2-1 Main screen in Generate Mode after selecting the P25 II soft key

Test Pattern (P25 II submenu)

Test Pattern provides selection for one of six TIA-102.CCAA compliant predefined bit patterns for BER testing of a P25 phase 2 radio in Receive Mode. The following patterns are available:

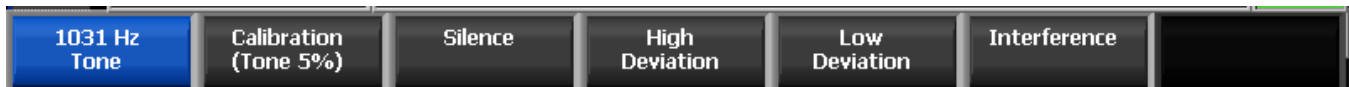

Figure 2.2.7.9.2-2 P25 II Generate Mode test patterns

1031 Hz Tone is the standard tone framed test pattern of the 1031 Hz vocoder tone for either modulation type and both logical channels.

Calibration (Tone 5%) is the test pattern derived from the standard 1031 Hz Tone test pattern to verify BER measurements are operating correctly for both modulation types and both logical channels. The first of every 20 bits is inverted (i.e. ~5%).

Silence is the framed test pattern for silence at the vocoder for either modulation type and both logical channels.

High Deviation is an unframed maximum frequency deviation test pattern of a continuously repeating stream of high deviation symbols (+3, +3, -3, -3, ...).

Low Deviation is an unframed test pattern of a continuously repeating stream of low deviation symbols (+1, +1, -1, -1, ...) for a 1/3 maximum frequency deviation.

Interference is the unframed standard interference test pattern as defined by the phase 2 standard and described by the phase 1 (C4FM) standard as yielding a silence output at the receiver vocoder and balanced to have approximately equal positive and negative signal deviations.

Modulation Type (P25 II submenu)

This key selects the desired type of modulation for the generated signal required by the receiver: HCPM or HDQPSK.

Modulation Mode (P25 II submenu)

A horizontal submenu provides choice of Off, Continuous, or Burst Mode for the selected Test Pattern modulation.

Logical Channel (P25 II submenu)

This key selects which logical channel for the transmitter to use (HCPM only), with ramp down to no power (unused null slot) and ramp up to the next used slot. The logical channel uses either time slot according to the asymmetrical superframe format (see Table 2.2.7.8.1.4-1 P25 Phase 2 Logical Channels (Inbound).)

2.2.7.10 AutoTune Test Mode

AutoTune is an optional automated test and alignment software application for manufacturer-specific radios embedded in the R8100. This eliminates the need for an external computer, simplifying setup and equipment costs for this function. A connection between an R8100 USB port and the radio under test controls the radio. The software automatically configures the analyzer and the radio to alleviate most operator intervention during alignment and test activities.

AutoTune performs recommended factory alignment procedures in addition to critical transmitter and receiver performance tests. AutoTune maintains detailed test logs and reports in *.csv (comma-separated values) file format. This can be conveniently viewed within the application or exported for further analysis by spreadsheet software and other data manipulation programs. A Demo version of AutoTune is installed on R8100 analyzers that are not equipped with a functional version. Figure 2.2.7.10-1 shows the AutoTune submenu screen.

AutoTune currently supports the following land mobile radio makes and models:

Motorola XTL 1500, XTL 2500, XTL 5000

Motorola XTS 1500, XTS 2500, XTS 5000

Motorola APX 7000, APX 7000XE, APX 6000, APX 6000XE, APX 6000Li, APX 5000, APX 4000, APX 4000 Li, APX 2000, APX 7500, APX 6500, APX 6500Li, APX 5500, APX 4500, APX 4500 Li, APX 2500

Motorola MOTOTRBO series portables and mobiles

Kenwood NX series portables and mobiles

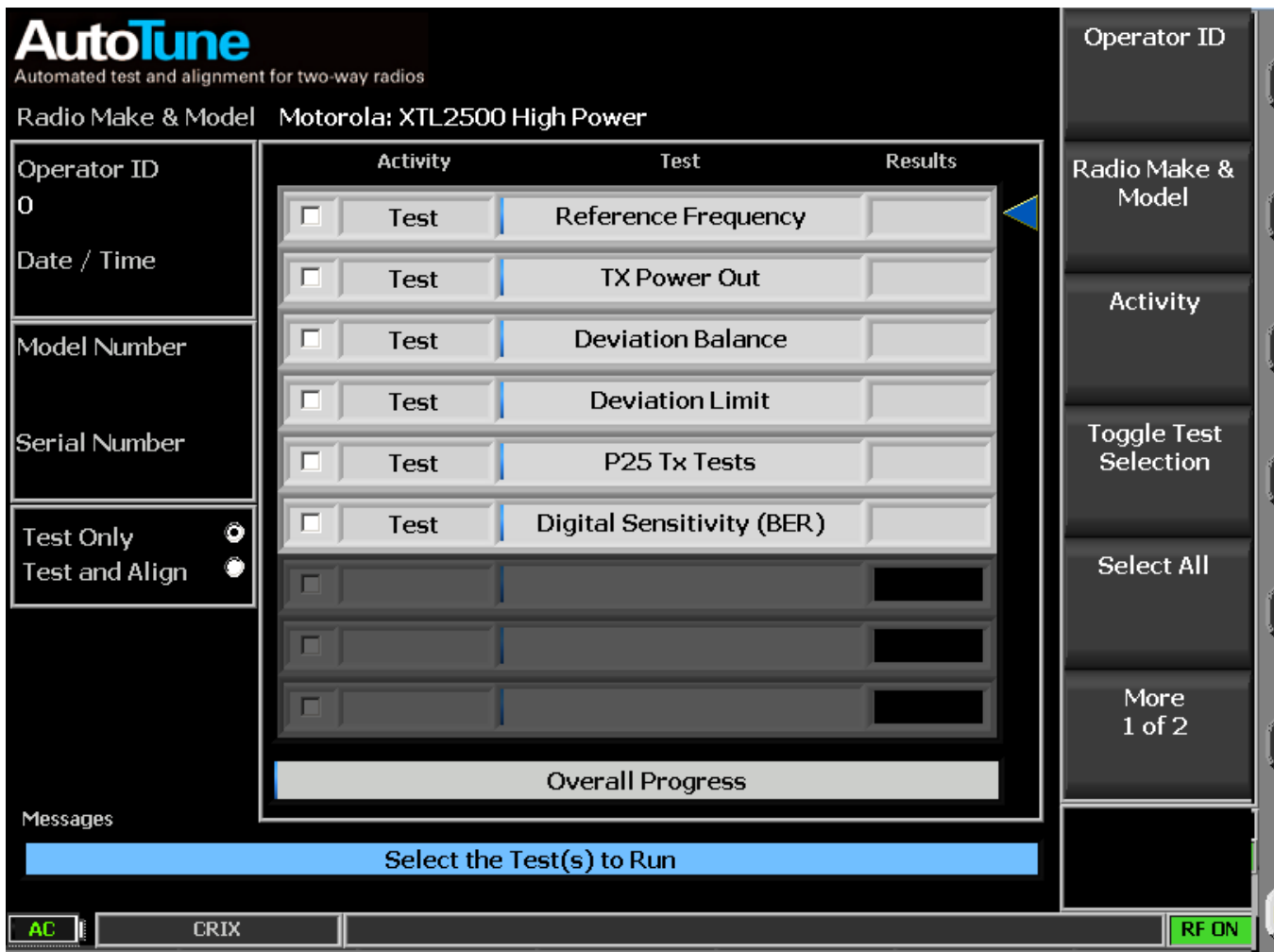

Figure 2.2.7.10-1 AutoTune submenu

AutoTune submenu selections are as follows:

Operator ID

Enter the test operator’s name/number in an alphanumeric entry window using the ◀▶ (Left/Right) keys, numeric keypad, ▲▼ (Up/Down) keys, and spin knob. Use Log Out Operator when testing is done. **Note:** *By default, an Operator ID is required to begin testing (Start soft key appears after entry is made). This can be changed in the “Preferences” selection under the “Tools” submenu.*

Radio Make & Model

Choose the manufacturer-specific radio to test in a list entry window using the ▲▼ (Up/Down) keys and spin knob. Upon selection, the AutoTune display provides a diagram for the connections between the R8100 and radio under test (see Figure 2.2.7.10-2). Pressing “Return” restores the main AutoTune display window.

Connect analyzer to radio test setup as shown.

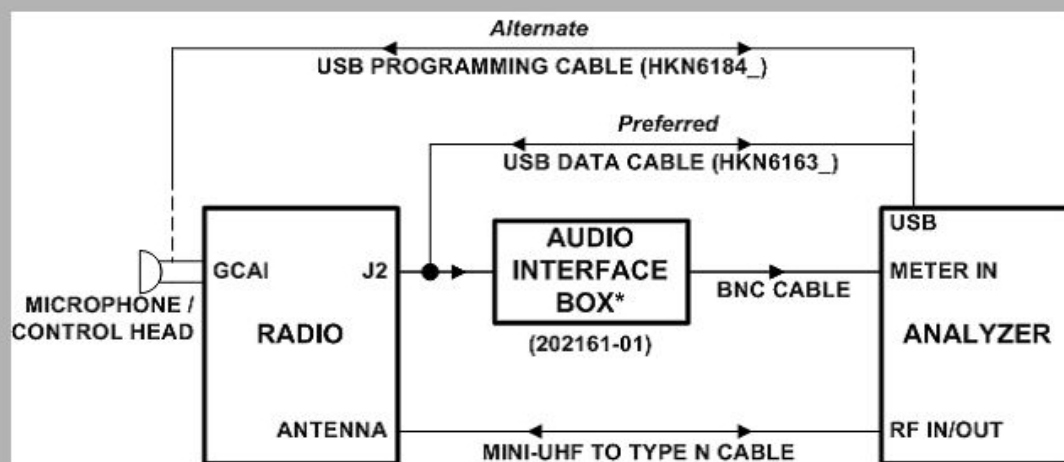

*Required only for Distortion, Sensitivity (SINAD), and Noise Squelch Threshold tests.



No Preset Loaded

RF OFF

Figure 2.2.7.10-2 AutoTune Radio Test Setup

Activity

Choose the AutoTune test activity either “Test Only” or “Test and Align” in a list entry window using the ▲▼ (Up/Down) keys and spin knob. “Test Only” measures and compares the radio’s performance against the manufacturer’s test limits without alignment; then, it indicates Pass/Fail in the “Results” column and displays detailed data in a test report. “Test and Align” performs a radio alignment, tests to the manufacturer’s limits, and then provides Pass/Fail results and a test report. Each test type can be selected and enabled by positioning the blue selection arrow using the Up/Down (▲▼) keys or spin knob. Use “Select All” to enable all tests or “Toggle Test Selection” for individual tests (see Figure 2.2.7.10-3).

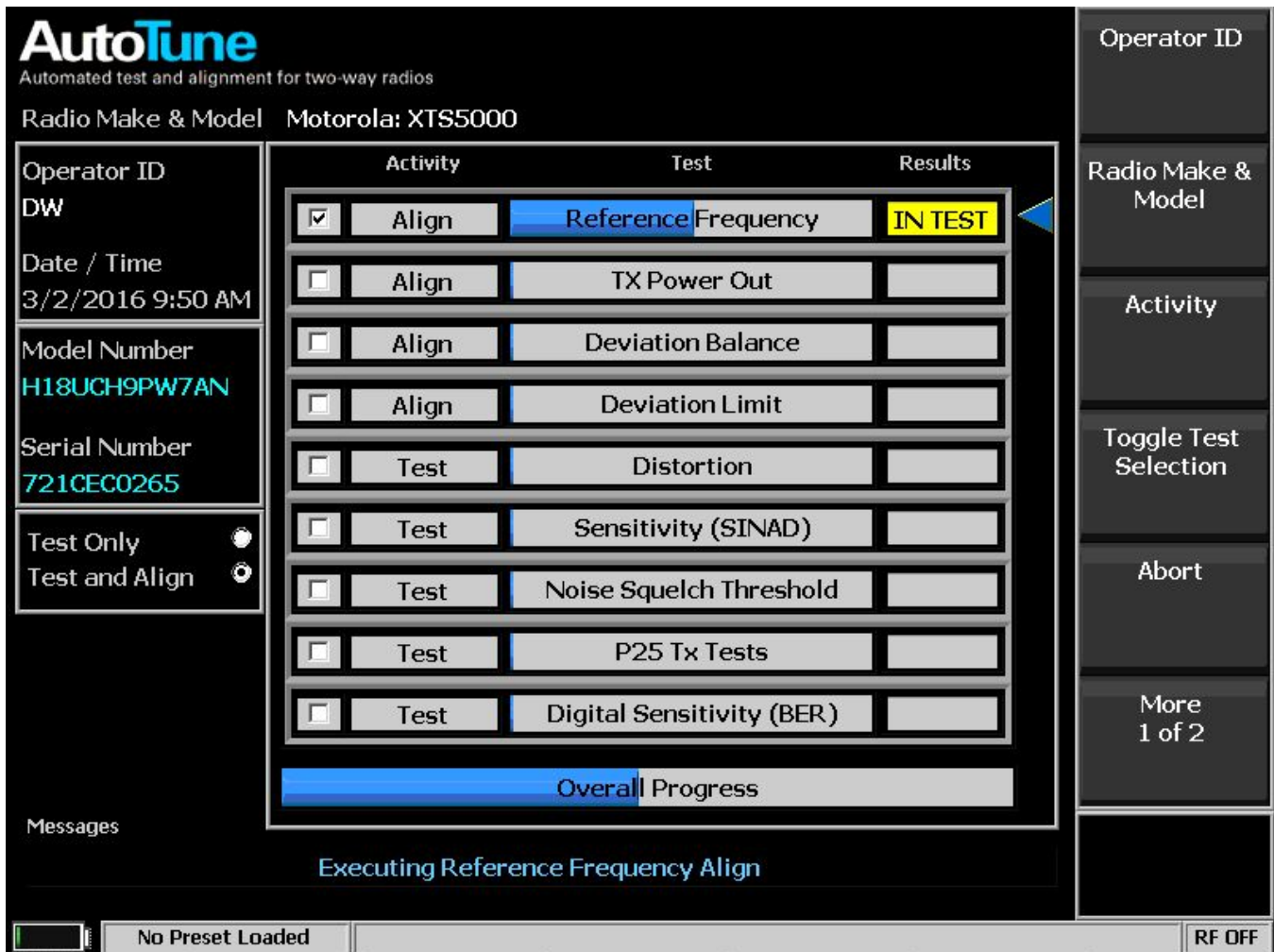

Figure 2.2.7.10-3 AutoTune Activity Display

Start

Press Start to begin the Test or Test and Align activities. The AutoTune application sequences each activity and displays an Overall Progress bar and “IN TEST,” “PASS,” “FAIL,” or “ABORT” in the “Results” column (see Figure 2.2.7.10-4). Upon completion of all selected activities, a Test Result Report is displayed along with a new submenu as shown in Figure 2.2.7.10-6. The submenu provides options to view the current test log and test reports along with saved previous data. Test logs and reports can be imported from or exported to a flash memory drive attached to one of the USB ports on the R8100.

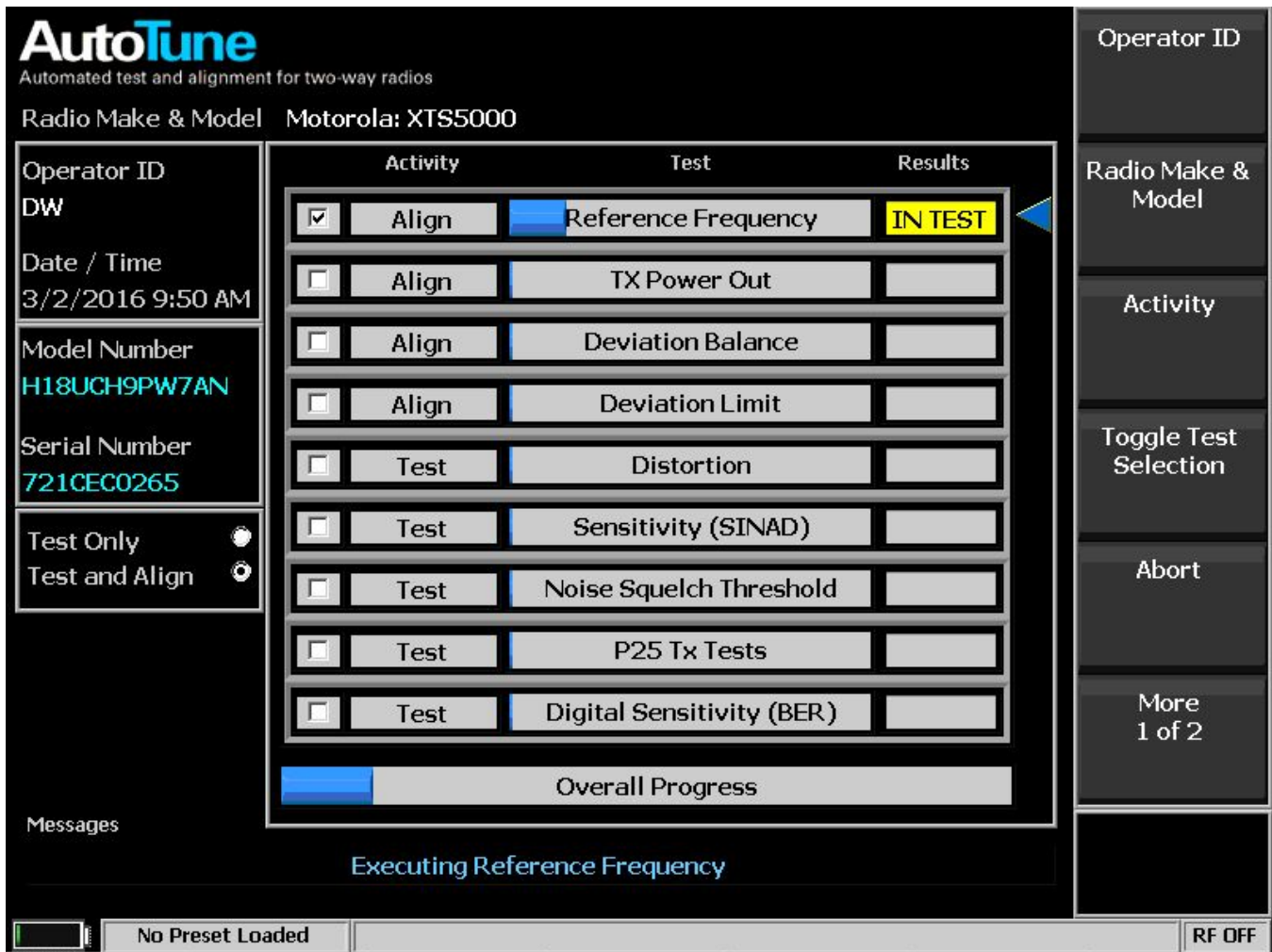

Figure 2.2.7.10-4 AutoTune test in progress

Abort

This key stops the current test activity in process. A Test Report displays all test results completed prior to the Abort command.

Select All

This key selects all test types listed in the “Test” column. AutoTune executes each in sequence once the Start soft key is pressed and displays a test report once they are all completed.

Toggle Test Selection

This key toggles the selection on or off for the individual test type highlighted by the blue arrow. Each test type can be selected by positioning the blue indicating arrow using the Up/Down (▲▼) keys or spin knob.

Clear All

The key de-selects or clears all enabled tests.

Tools

This key provides a selection of horizontal soft keys used to adjust test limits, access test reports, and set program operational preferences as follows:

Test Limits key displays a screen and submenu for pass/fail limits of the selected radio make used to edit test limits for the manufacturer-specific radio under test (see Figure 2.2.7.10-5). Each test type can be selected by positioning the blue indicating arrow with the Up/Down (▲▼) keys or spin knob. Press the “Edit Test Limit” soft key to activate a data entry window and adjust the numeric value using the ◀▶ (Left/Right) keys, numeric keypad, ▲▼ (Up/Down) keys, and spin knob.

Test Report key displays a screen and submenu of test logs used to view or delete the current or a previous test log, which contains a report for each test performed in a test session (see Figure 2.2.7.10-6). Test logs are saved in *.csv format to allow exporting to a spreadsheet or other data manipulation program. Individual test logs and test reports can be imported from or exported to a flash memory drive attached to one of the USB ports on the R8100. The following Test Report choices are available:

Preferences – Displays a screen and submenu used to enable or disable automatic settings for Operator ID, Display Report, Unique Log Files, and Display Setup Diagrams (see Figure 2.2.7.10-7).

Log Out Operator

This key clears the Operator ID field when the operator is finished. This ensures that test logs and reports are assigned to the next operator, if Operator ID is required to start activity (see Preferences).

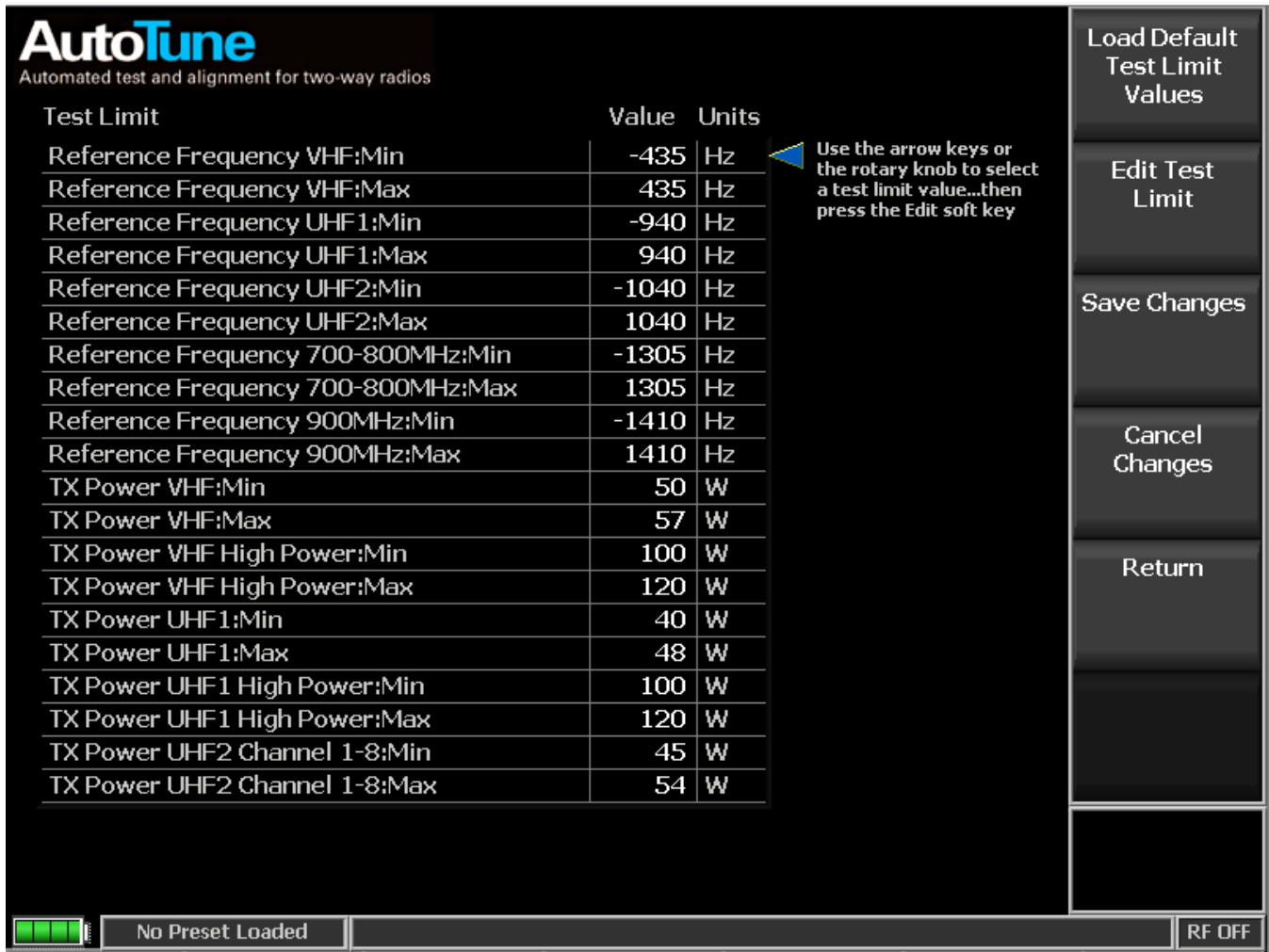

Figure 2.2.7.10-5 AutoTune Test Limits submenu

Load Default Test Limit Values (Test Limits submenu)

This key resets all test limits for the currently-selected radio model to their factory default values.

Edit Test Limit (Test Limits submenu)

This key activates a data entry window to adjust the numeric test limit value using the ◀▶ (Left/Right) keys, numeric keypad, ▲▼ (Up/Down) keys, and spin knob. Each test limit value can be selected by positioning the blue indicating arrow with the Up/Down (▲▼) keys or spin knob.

Save Changes (Test Limits submenu)

This key stores the edited limits for use by all future activities.

Cancel Changes (Test Limits submenu)

This key restores all edited and unsaved test limit values.

Return (Test Limits submenu)

This key returns to the Main AutoTune menu.

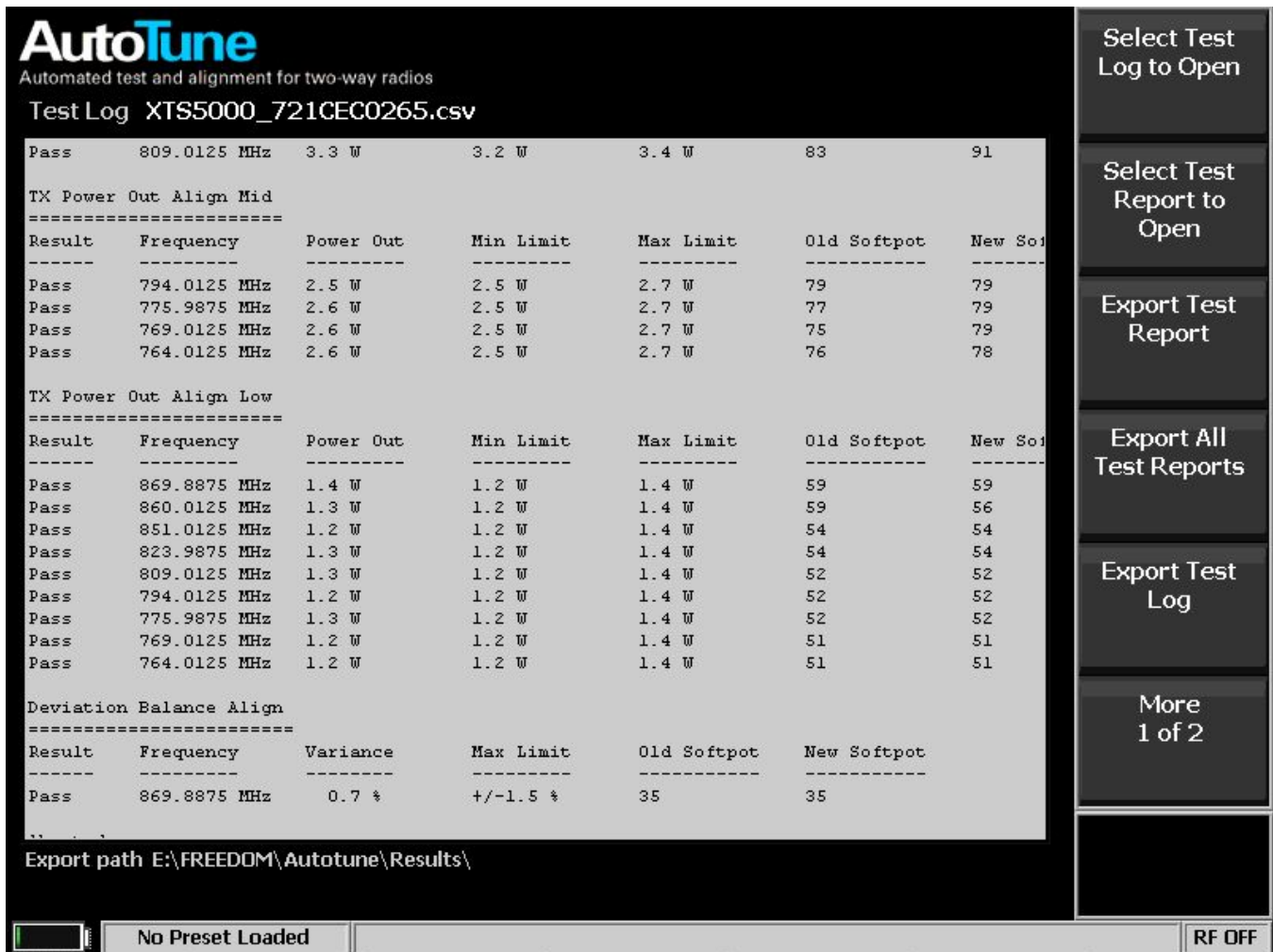

Figure 2.2.7.10-6 AutoTune Test Results Submenu

Select Test Log to Open (Test Reports submenu)

This key opens a previously saved Test Log that contains the test reports from a previous test session.

Select Test Report to Open (Test Reports submenu)

This key opens an individual Test Report from within the current Test Log or a previously loaded one.

Export Test Report (Test Reports submenu)

This key copies an individual Test Report from within the current Test Log to a USB drive.

Export All Test Report (Test Reports submenu)

This key copies all Test Reports from within the current Test Log to a USB drive.

Export Test Log (Test Reports submenu)

This key copies a previously saved Test Log that contains the test reports to a USB drive.

Export All Test Logs (Test Reports submenu)

This key copies all previously saved Test Logs that contain the test reports to a USB drive.

Delete Test Log (Test Reports submenu)

This key erases the current Test Log.

Return (Test Reports submenu)

This key returns to the Main AutoTune menu.

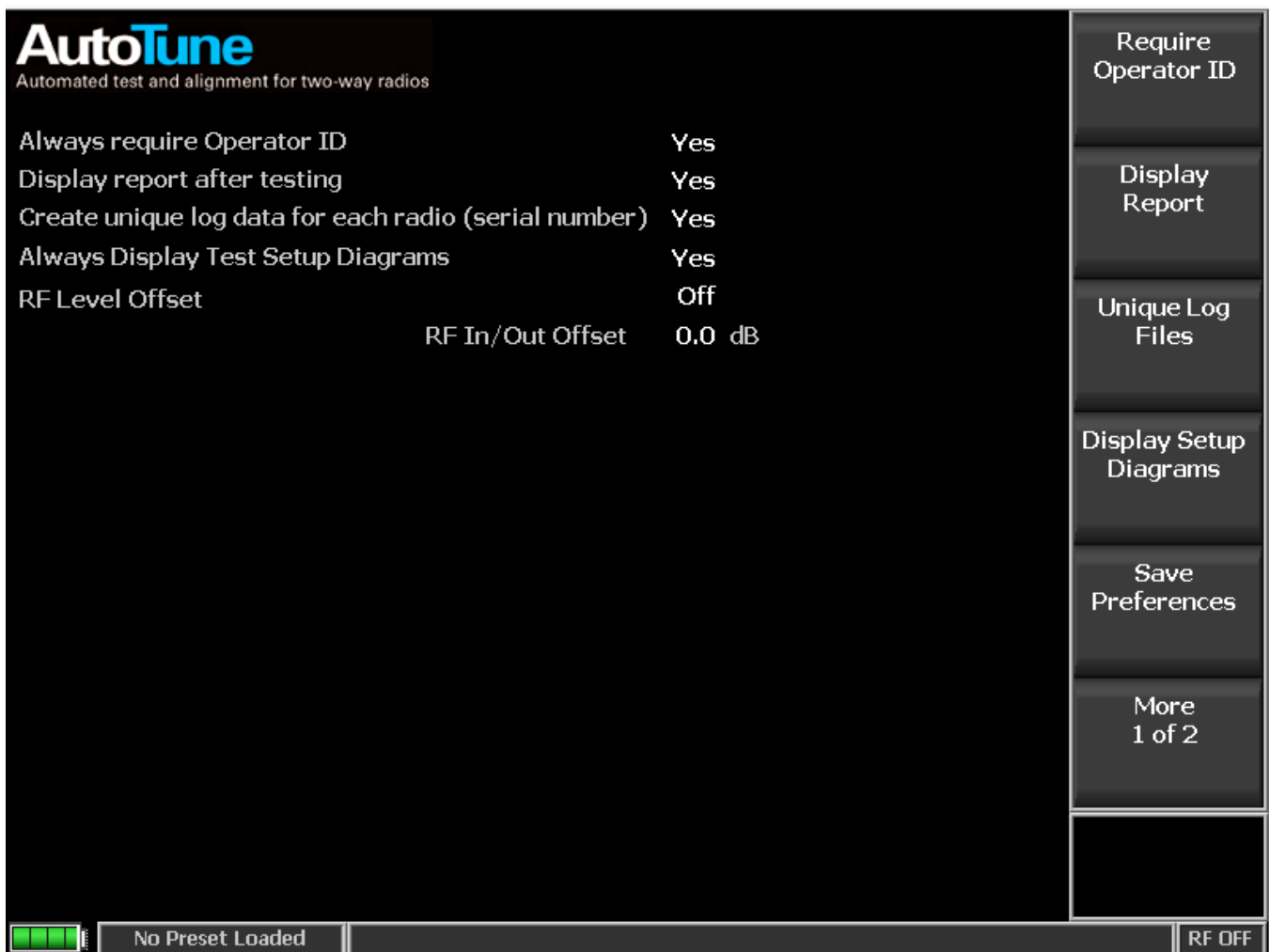

Figure 2.2.7.10-7 AutoTune Test Preferences Submenu

Require Operator ID (Test Preferences submenu)

AutoTune requires the Operator ID to be set before testing can be initiated because it is logged in the test data and reported in the formatted test report. If the field is blank, the operator is not recorded. Setting this preference to No will allow testing to be started without an Operator ID.

Recommended: Site preference

Default: Yes

Display Report (Test Preferences submenu)

AutoTune stores the results from each test in a comma-delimited log file. These results can be viewed at any time by clicking on the Tools' "Test Reports" button on the AutoTune screen. The button displays the logged test results in an easy to read format. AutoTune will automatically display this screen at the completion of all tests.

Setting this preference to No will prevent the Test Report from being displayed when testing is complete.

Recommended: Site preference

Default: Yes

Unique Log Files (Test Preferences submenu)

Test log data is recorded and saved to a comma-delimited format filename based on the serial number of the radio under test (e.g. XTS5000_11124.csv). Setting this preference to No will cause all test log data to be saved under a common log file name based on the radio make and model (e.g. XTS5000.csv).

Recommended: Set to No if testing and reporting a batch of radios.

Default: Yes

Display Setup Diagrams (Test Preferences submenu)

This setting controls the display of Test Setup Diagrams at the start of testing. When No, the diagrams will not be shown.

Note: *If the radio under test requires the test setup to be changed during testing, this option will be ignored. In this situation, it is critical that the user review the diagrams to ensure that the cable setup is correct. Incorrect setup will result in false test failures and possibly damage the radio or analyzer.*

Recommended: Yes

Default: Yes

RF Level Offset (Test Preferences submenu)

When enabled, the R8100 applies the RF offset in the RF In/Out field next to it to the output levels and input power measurements used by AutoTune. When disabled (default), the value in the RF In/Out field is ignored.

This field mirrors the RF Level Offset field described in System Settings.

Recommended: Site preference

Default: No

RF In/Out (Test Preferences submenu)

This field specifies the gain or loss between the RF In/Out port and the unit under test.

In the case of a loss, such as a cable or attenuator, enter a *negative* value. The affected field values will be *increased* to compensate. In Generate Mode, for example, if a -6.0 dB value is entered, the Output Level amplitude is *increased* by 6 dB. In Monitor Mode, for example, the input level is *increased* by 6 dB.

In the case of a gain, such as an amplifier, enter a *positive* value. The affected fields will be *decreased* to compensate. In Generate Mode, for example, if a 10.0 dB value is entered, the Output Level amplitude will *decrease* by 10 dB. In Monitor Mode, for example, Wattmeter measurements will be *reduced* by 10 dB.

This value is not used if RF Level Offset is disabled (Off). This field mirrors the RF In/Out field described in System Settings.

Recommended: Site preference

Default: 0.0

Save Preferences (Test Preferences submenu)

This selection stores the edited preferences for use by all future activities.

Return (Test Preferences submenu)

This key returns to the Main AutoTune menu.

2.2.7.11 AutoScript (BETA) Test Mode

AutoScript provides monitor and control (M&C) script execution from within the R8100. Using this feature, repetitive measurements normally requiring several keystrokes can be programmed into plain text scripts and the results written to an exportable log file. Scripts are imported into the R8100 using a USB drive and may be combined together to form procedures. Procedures can be saved and recalled to run a particular set of scripts.

This feature is currently in beta testing. Future AutoScript versions may have an altered user interface, different script format, or other significant modifications as user feedback warrants. Recommended current use is limited to small-scale R8100 measurement automation only.

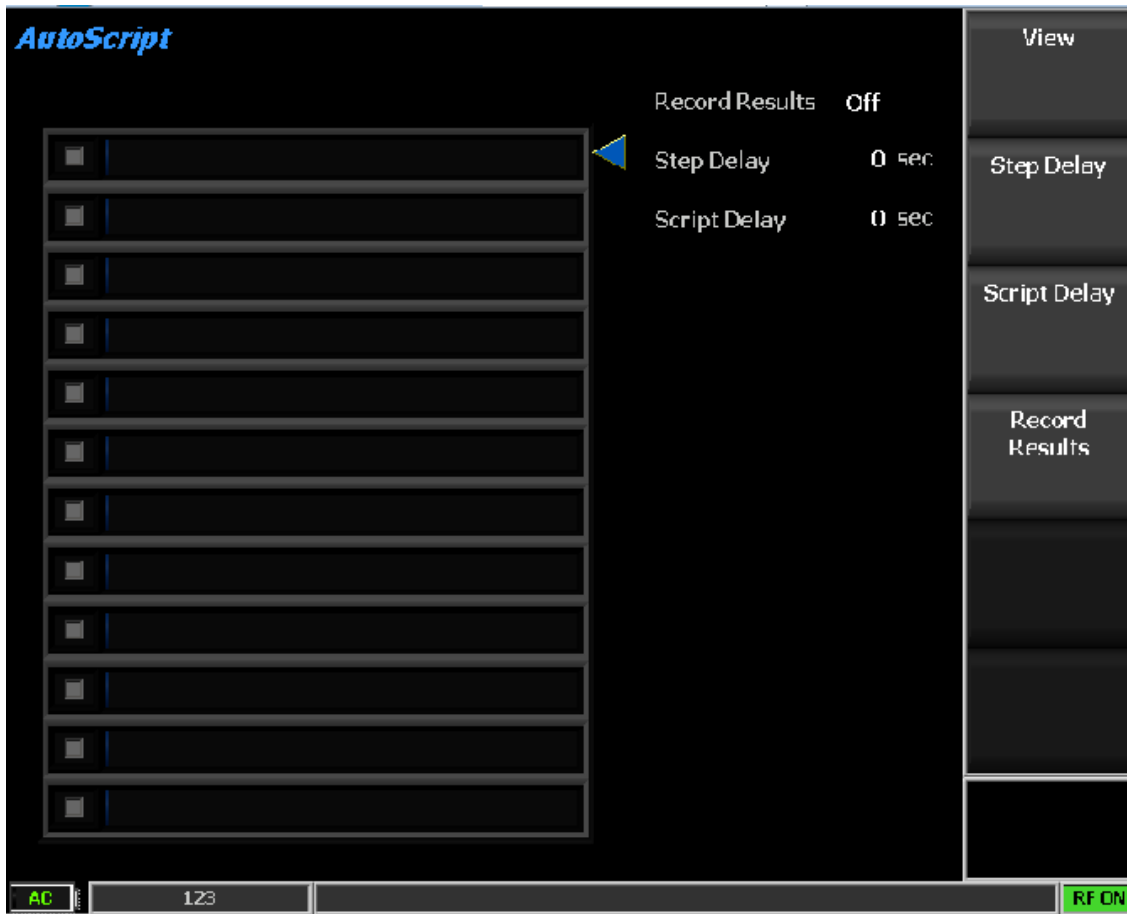

Figure 2.2.7.11-1 AutoScript submenu with no scripts or procedures imported

AutoScript submenu selections are as follows:

Step Delay

This selection controls the delay between each script step or line in the script during script execution.

Default: 0 seconds

Script Delay

This selection controls the delay between each script selected for execution.

Default: 0 seconds

Record Results

This selection controls whether to send execution results to a file.

Default: Off

View

This selection toggles between script and results submenus (see Figure 2.2.7.11-2).

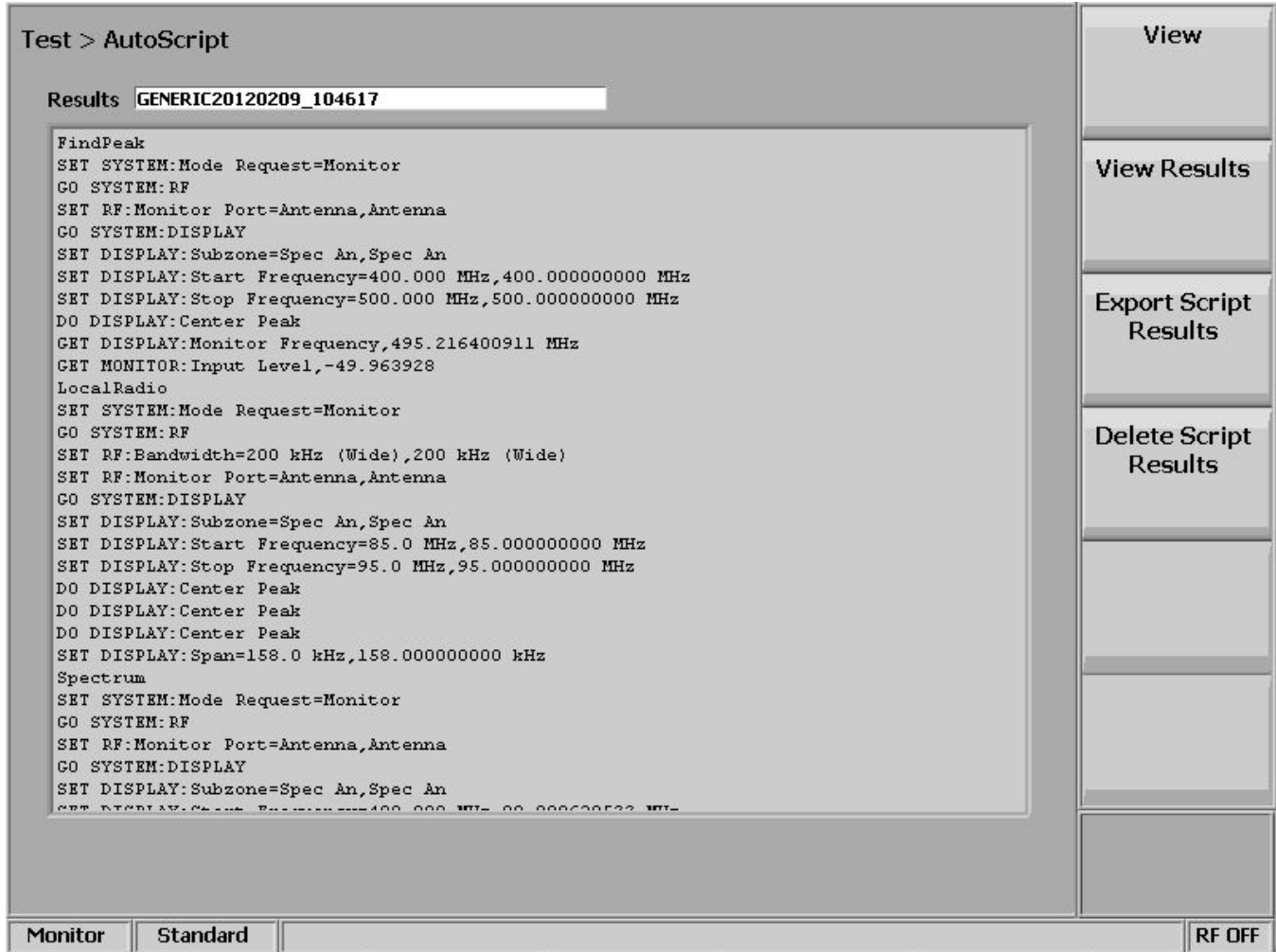

Figure 2.2.7.11-2 View, Results submenu with results from a procedure execution displayed

Import Scripts

Import scripts from a USB drive to the unit's hard drive. When selected, it provides a list of scripts available for import.

Note: Visible only when a USB drive containing scripts in the correct subfolder (<USB_Drive>:\FREEDOM\AutoScript) is inserted into the unit.

Import Procedures

Import procedures from a USB drive to the unit's hard drive. When selected, it provides a list of procedures available for import.

Note: Visible only when USB drive containing procedures in correct subfolder (<USB_Drive>:\FREEDOM\AutoScript) is inserted into the unit. After one or more scripts and/or procedures are imported, additional soft keys appear to manipulate and execute them.

Toggle Selection

This selection enables or disables script selected by the selection marker (blue triangle) for AutoScript execution or procedure creation. Move the selection marker with the spin knob or up/down keys. If Start AutoScript or Save as Procedure soft keys are selected, only enabled scripts are utilized. See Figure 2.2.7.11-3 for an example.

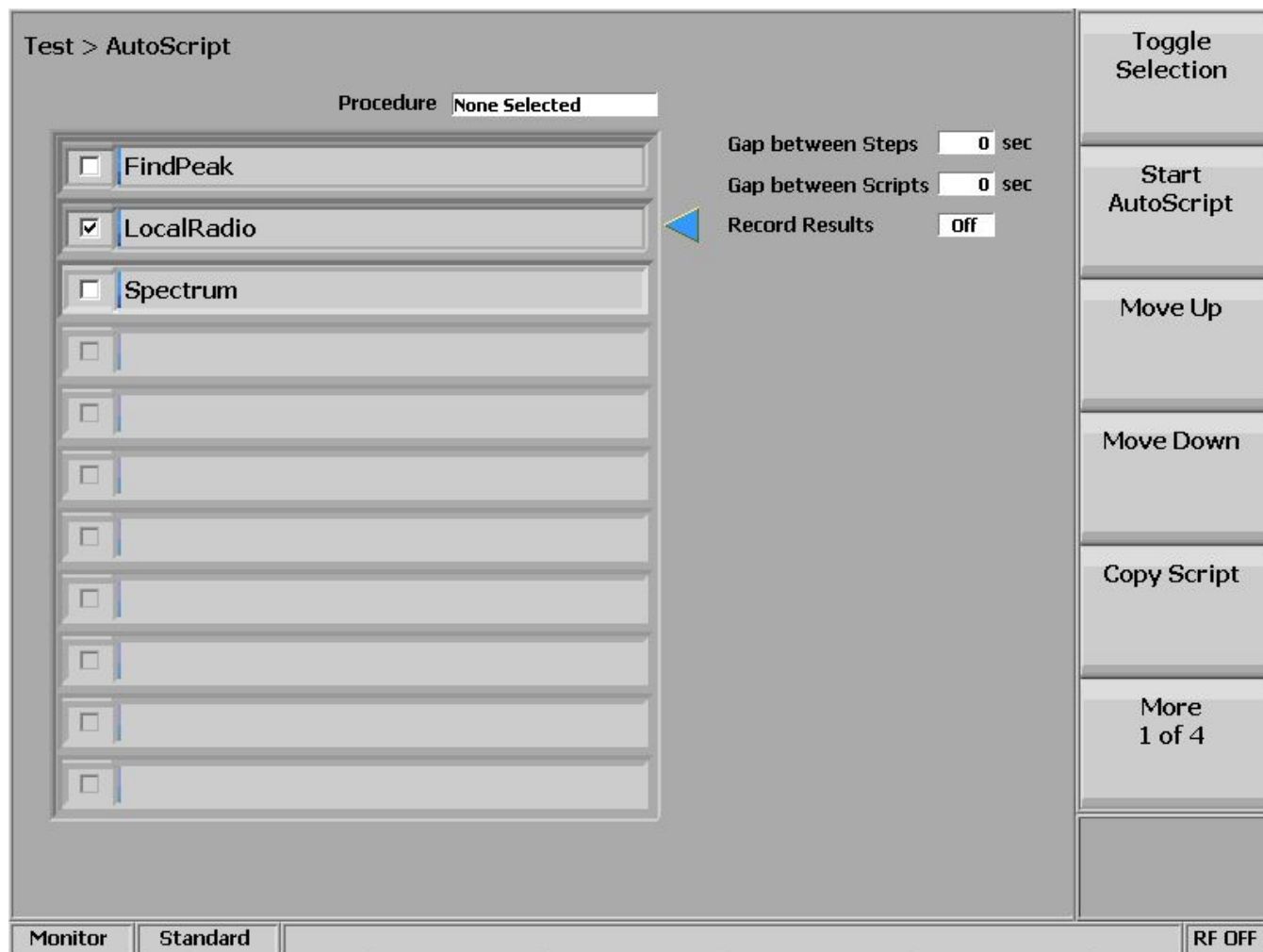

Figure 2.2.7.11-3 Use Toggle Selection to enable or disable script execution

Start AutoScript

This selection begins execution of enabled scripts in the script list. During execution, front panel button selections are ignored until AutoScript completes. An exception to this behavior is if an AutoScript prompt appears. In this case, soft keys are active to allow user input. For more information about running scripts, see Section 2.2.7.11.1.

Note: *Visible only when at least one script is enabled with Toggle Selection.*

Move Up

This key shifts script at selection marker up one row in script list. Any script in row above selected script is shifted down into selected script's old row.

Move Down

This key shifts script at selection marker down one row in script list. Any script in row below selected script is shifted up into selected script's old row.

Copy Script

This key duplicates the script at the selection marker into the next row so that it can be run more than once. It may be moved up or down afterwards. The copy is only a reference to the script file and will not be retained if the R8100 Power is turned off. However, the duplication may be retained with Save as Procedure.

Note: *Visible only when a script exists on the unit's hard drive.*

Load Procedure

This key loads and enables scripts saved in a procedure into the script list. Any current script list scripts not part of the loaded procedure are removed from the script list. Procedures may be imported from an external USB drive or created using the Save as Procedure soft key. If a loaded procedure references scripts which have not been imported to the unit's hard drive, a warning message is given, and the procedure is not loaded. See Figure 2.2.7.11-4 for example submenu after loading a procedure named GENERIC.

Note: *Visible only when at least one procedure is present on the unit's hard drive.*



Figure 2.2.7.11-4 Use Toggle Selection to enable or disable script execution

Save as Procedure

This key creates a newly-named procedure from enabled scripts in the script list. Once created, the procedure is available for selection using the Load Procedure soft key.

Note: *Visible only when a script exists on the unit's hard drive.*

Refresh Scripts

This key refreshes script list with currently available scripts imported to the unit's hard drive. If a procedure was loaded before selecting this soft key, its scripts are replaced with the list of scripts currently available for execution on the unit.

Note: *Visible only when a script exists on the unit's hard drive.*

Export Procedure

This key exports one or more procedures from the unit's hard drive to a USB drive. When selected, a list of procedures available for export is provided.

Note: *Visible only when a USB drive is inserted into the unit and at least one procedure is available for export.*

Delete Scripts

This key deletes the selected script from the unit's hard drive and removes all references to it from the script list. After being deleted, that script must be imported again to use it in AutoScript.

Note: *Visible only when a script exists on the unit's hard drive.*

Delete Procedure

This key deletes the selected procedure from the unit's hard drive. After being deleted, that procedure must either be imported again or recreated from available scripts on the unit's hard drive to be used in AutoScript.

Note: *Visible only when a procedure exists on the unit's hard drive.*

2.2.7.11.1 How-To

In order to use the AutoScript feature, scripts must be created and imported to the unit. Script format follows the Monitor and Control (M&C) command format as detailed in the R8100 Monitor & Control Programmer's Guide (CG-1110). Each line in the script is to contain an M&C command and must conform to M&C syntax rules.

Scripts may be created or edited using a text editor such as Windows Notepad. Script file names must end in ".txt." Procedure file names must end in ".prc."

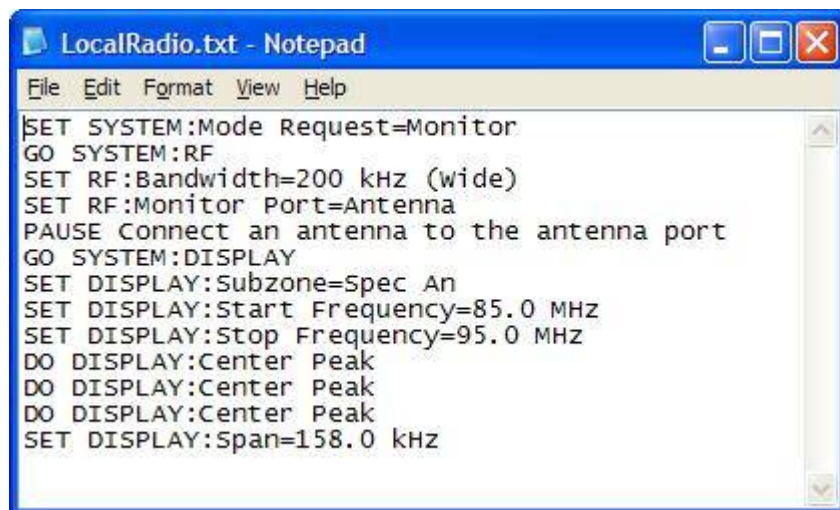

```
File Edit Format View Help
|SET SYSTEM:Mode Request=Monitor
GO SYSTEM:RF
SET RF:Bandwidth=200 kHz (wide)
SET RF:Monitor Port=Antenna
PAUSE Connect an antenna to the antenna port
GO SYSTEM:DISPLAY
SET DISPLAY:Subzone=Spec An
SET DISPLAY:Start Frequency=85.0 MHz
SET DISPLAY:Stop Frequency=95.0 MHz
DO DISPLAY:Center Peak
DO DISPLAY:Center Peak
DO DISPLAY:Center Peak
SET DISPLAY:span=158.0 kHz
```

Figure 2.2.7.11-5 Example script showing commands for finding a local FM radio station

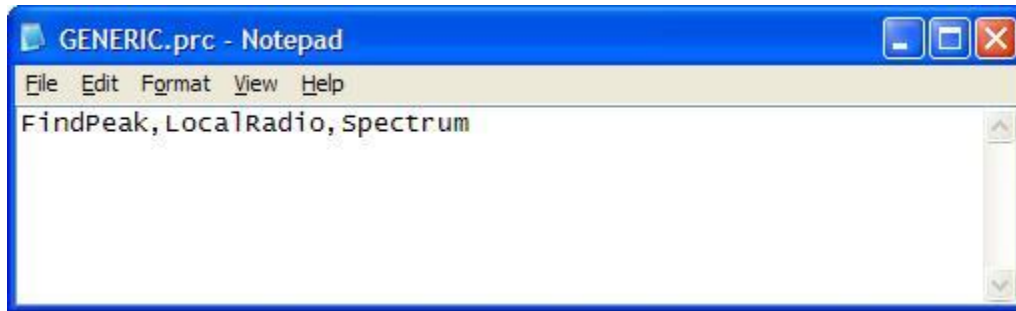

Figure 2.2.7.11-6 Example procedure containing several scripts

The following steps may generally be followed to import, execute, and return the results of AutoScript scripts:

1. Copy valid scripts to an available USB drive.
2. Insert USB drive into the R8100.
3. Navigate to AutoScript menu by selecting Test, AutoScript (BETA) soft key.
4. Import scripts by selecting Import Scripts soft key and the appropriate list box script entry.
5. Refresh script list to reflect the unit's hard drive contents by selecting Refresh Scripts soft key.
6. Select all script list rows in succession with selection marker and enable them using Toggle Selection soft key.
7. Select Save as Procedure soft key, and give procedure a meaningful name.
8. Select Load Procedure and the procedure name to load the procedure scripts into the script list.
9. Set Record Results to Off.
10. Select Start AutoScript soft key. Once AutoScript has begun running, the lower left hand corner of the R8100 display will blink, and the word "AutoScript" will periodically appear with a green background.
11. If a problem is detected in a script, AutoScript will display message 6053 describing the failure. The message will be displayed on the message bar and Settings > Messages screen. The error message displays the name of the script, the number of the line which failed, and the response code for that line. See CG-1110, General usage, Responses Section for a description of each code. AutoScript stops at that line; subsequent lines are not executed.
12. If multiple messages have been reported, the message bar will scroll through each one. Use the Settings > Messages screen to acknowledge old ones so new ones will be displayed right away.
13. Once scripts are complete and the AutoScript menu is visible again, select View, Results, View Results soft keys, and the named procedure entry. The entry will be named using the procedure name and the runtime timestamp.
14. To send the results file to the USB drive, select Export Script Results, All soft key. Results files are stored in comma-separated values (*.csv) format.

2.2.7.11.2 Keywords

In addition to M&C commands, the following keywords are available for scripting and automated execution of procedures:

1. DELAY - wait for a specified number of seconds. Whereas a line delay can be set from the graphical user interface, doing so affects all lines which could make the script laboriously slow if a large delay is needed after just one.
2. PAUSE - generate custom user prompts. The text appearing after the keyword is displayed on the unit screen, and execution waits until the user responds with a soft key press. For example, see Figure 2.2.7.11-5.

2.2.8 Settings Menu

R8100 configuration settings and system information are accessed by pressing the Settings navigation button (see Figure 3.2.9-1). The submenu presents a user initiated self-calibration function and various configuration settings that affect R8100 operation. It also presents information on the unit's firmware, installed options, and diagnostic messages generated during operation.

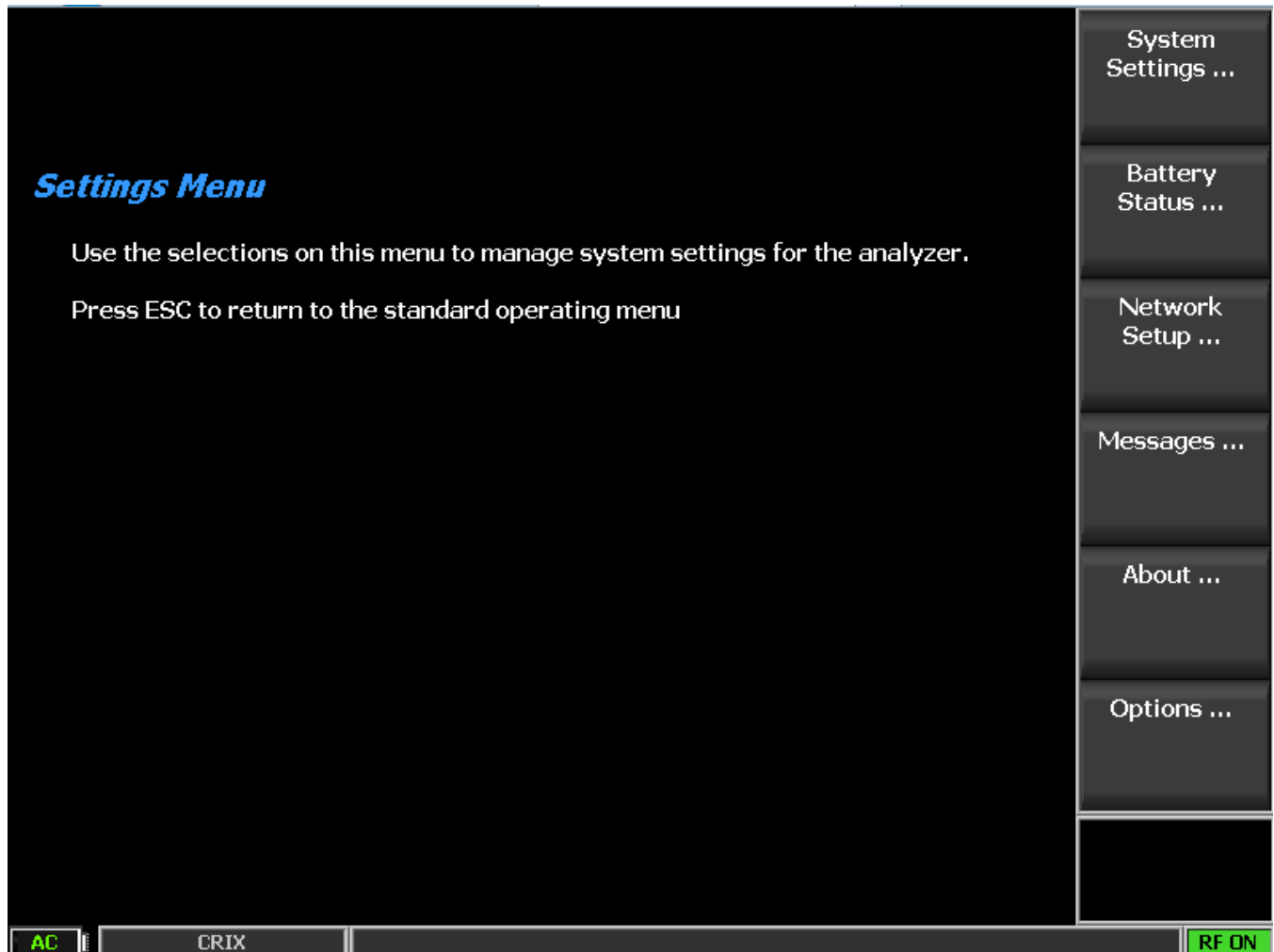

Figure 3.2.9-1 Submenu after pressing Settings navigation button on R8100 front panel

2.2.8.1 Calibration

The R8100 has a calibration function to assure accurate and consistent performance over time and in a variety of environmental settings. The options presented by the Calibration soft key are as follows:

Calibrate Now

This key initiates a self-alignment process for the R8100 to compensate for component aging or adjust operation to a significant change in external environmental temperature. New calibration values are generated and stored in memory and used for future operation of the R8100. (See Appendix C – R8100 Field Calibration Procedure.)

Load Factory Defaults

Note: *This is an upcoming feature. The calibration values generated during factory alignment prior to shipment are loaded. These establish a nominal baseline for R8100 operation in the event the user generated self-calibration tables are lost or corrupted.*

2.2.8.2 System Settings

The R8100 has hardware configuration settings that are accessed in the Systems Settings submenu. Once set, these parameters are not affected by the operational mode or other choices in the R8100 menu system. Figure 3.2.9.2-1 shows the Systems Settings submenu, and the options are as follows:

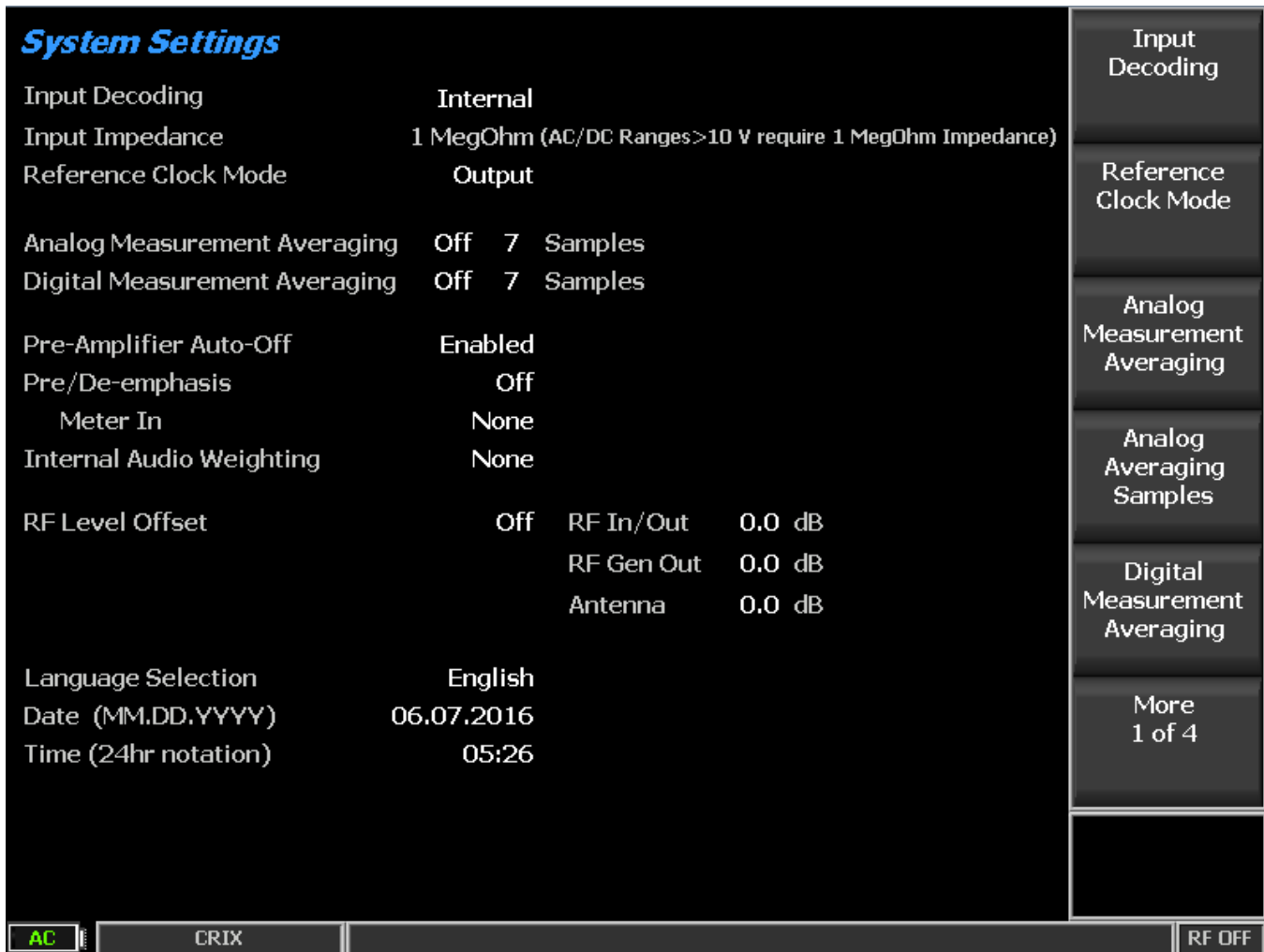

Figure 3.2.9.2-1 Submenu after pressing System Settings soft key in the Settings menu

Input Decoding

This key selects the signal source used for the R8100 frequency counter and decode functions. When set to Internal, the recovered audio or tones from a demodulated received signal are used as the signal source. The External setting directs an externally-applied signal at the Meter In port to the R8100 frequency counter and decode circuits.

Input Impedance

This key selects the input impedance for the Meter In port to either 600 Ω or 1 M Ω . **Note:** To prevent damage to the R8100, the 600 Ohm input impedance is restricted to AC and DC ranges of 10 Volts or less. Both the AC and DC voltmeters must be set to a range of 10 Volts or less before 600 Ohms can be selected.

Reference Clock Mode

This key selects the mode for the 10 MHz Ref In/Out connector at the side of the R8100. “Output” routes the internal 10 MHz time base signal to the 10 MHz Ref In/Out connector for use as a frequency reference

by external equipment. “Input” allows an external time base signal applied to the 10 MHz Ref In/Out connector to be routed into the R8100.

Analog Measurement Averaging

This key enables measurement averaging to smooth selective analog readings. Analog Measurement Averaging affects the following:

RF Zone – Frequency Error, Deviation

Display Zone – Frequency Error Bar Graphs, Deviation Bar Graphs

Meter Zone – AC Volts, DC Volts, Internal Distortion, External Distortion, SINAD

Analog Averaging Samples

This key sets the number of samples used from two to 100 when Analog Measurement Averaging is enabled.

Digital Measurement Averaging

This key enables measurement averaging to smooth selective digital readings. Digital Measurement Averaging affects the following:

DMR Zone – Symbol Deviation, FSK Error; Magnitude Error

PROJECT 25 Zone – Symbol Deviation, Modulation Fidelity

P25 Trunk Zone – Symbol Deviation, Modulation Fidelity

NXDN™ Zone – Symbol Deviation, Modulation Fidelity

TETRA Zone – Averaging is controlled locally; see 2.2.7.7.1.2

Digital Averaging Samples

This key sets the number of samples used from two to 100 when Digital Measurement Averaging is enabled.

Pre-Amplifier Auto Off

When enabled (default), the R8100 automatically switches off the Pre-Amplifier to maintain measurement accuracy when broadband RF power measurements are selected or detected. A message appears for several seconds informing the user that the Pre-Amplifier will be turned off. If a user chooses to override the setting, an alert is displayed as shown in Figure 3.2.9.2-2.

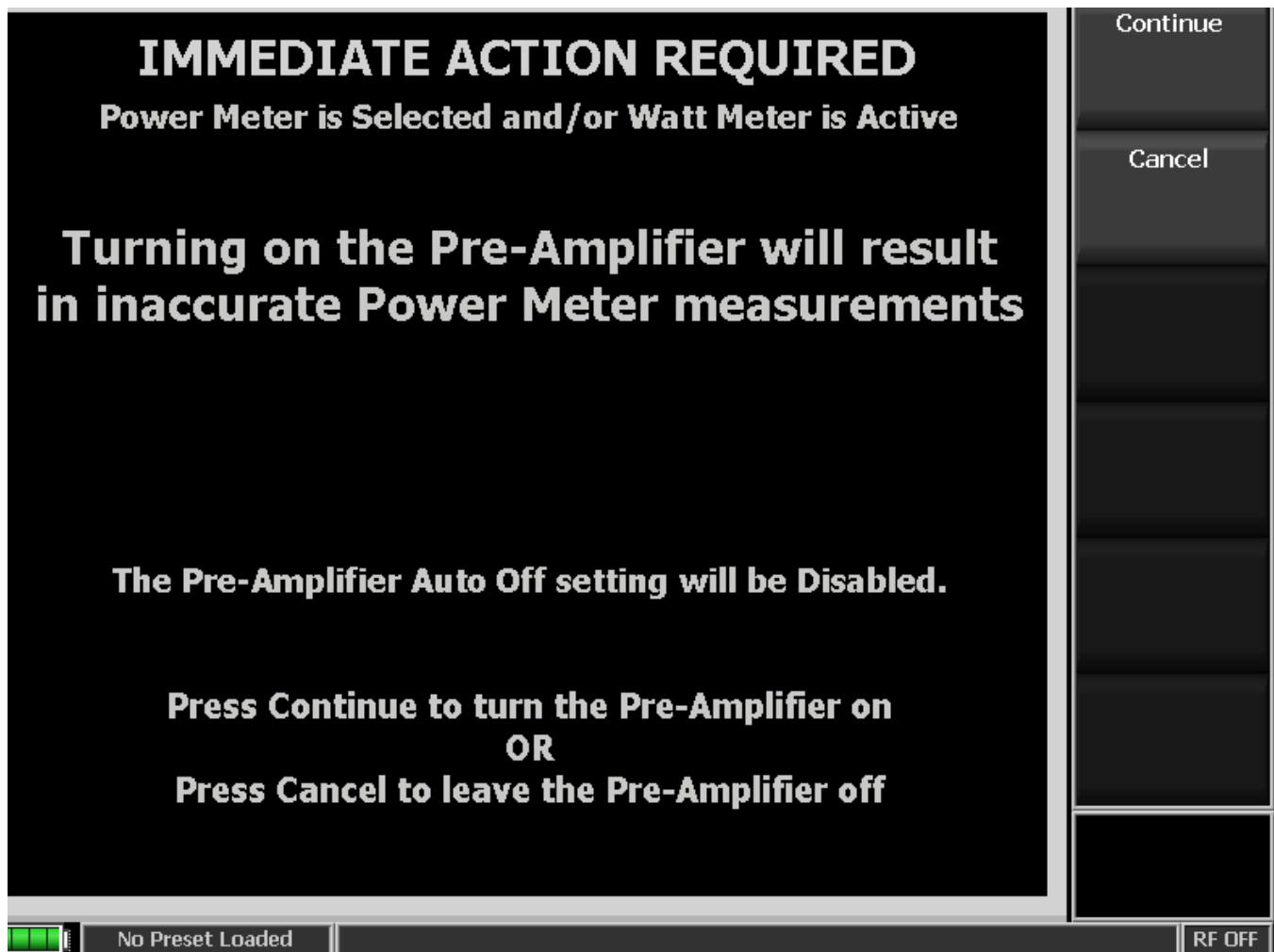

Figure 3.2.9.2-2 Pre-Amplifier alert when broadband measurements are active

Pre/De-emphasis

This selection enables or disables (default) emphasis network for internally-coupled audio signals. When enabled, the R8100 applies pre-emphasis to audio signals before they modulate the RF carrier and de-emphasis to audio signals demodulated from the RF carrier.

Meter In Filter

This selection allows selection of various filters to apply to external audio signals measured at the Meter In port. Settings include:

None – No filtering is applied to signal.

C-Msg – Applies a C-Message weighting filter to signal

CCITT – Applies a ITU-T O.41 weighting filter to signal

De-emphasis – Applies de-emphasis filter to signal

Internal Audio Weighting

This selection allows selection of various filters to apply to internal demodulated audio signals. Settings include:

None – No filtering is applied to signal.

C-Msg – Applies a C-Message weighting filter to signal

CCITT – Applies a ITU-T O.41 weighting filter to signal

RF Level Offset

When enabled, the R8100 applies the RF offsets in the RF In/Out, RF Gen Out, and Antenna fields below it to various TX signals and RX measurements. When disabled (default), the values in the RF In/Out, RF Gen Out, and Antenna fields are ignored. Affected fields include:

Output Level

Tracking Generator Output Level

Input Level

Power Meter/Wattmeter

Spectrum Analyzer trace, on both Display Zone and in Spectrum Analyzer and Dual Display Instruments

Tracking Generator trace

DMR and TETRA Power Profile trace

TETRA unwanted power

AutoTune output and input levels

RF In/Out

This selection specifies the gains or losses between the RF In/Out port and the unit under test.

In the case of a loss, such as a cable or attenuator, enter a *negative* value. The affected field values will be *increased* to compensate. In Generate Mode, for example, if a -6.0 dB value is entered, the Output Level amplitude is *increased* by 6 dB. In Monitor Mode, for example, the Spectrum Analyzer trace is *increased* by 6 dB.

In the case of a gain, such as an amplifier, enter a *positive* value. The affected fields will be *decreased* to compensate. In Generate Mode, for example, if a 10.0 dB value is entered, the Output Level amplitude will *decrease* by 10 dB. In Monitor Mode, for example, Wattmeter measurements will be *reduced* by 10 dB.

This value is not used if RF Level Offset is disabled (Off).

RF Gen Out

This selection specifies the gains or losses between the RF Gen Out port and the unit under test.

In the case of a loss, such as a cable or attenuator, enter a *negative* value. The affected field values will be *increased* to compensate. For example, if a -6.0 dB value is entered, the Output Level amplitude is *increased* by 6 dB.

In the case of a gain, such as an amplifier, enter a *positive* value. The affected fields will be *decreased* to compensate. For example, if a 10.0 dB value is entered, the Output Level amplitude will *decrease* by 10 dB.

This value is not used if RF Level Offset is disabled (Off).

Antenna

This selection specifies the gains or losses between the Antenna port and the unit under test.

In the case of a loss, such as a cable or attenuator, enter a *negative* value. The affected field values will be *increased* to compensate. For example, if a -6.0 dB value is entered, the Spectrum Analyzer trace is *increased* by 6 dB.

In the case of a gain, such as an amplifier, enter a *positive* value. The affected fields will be *decreased* to compensate. For example, if a 10.0 dB value is entered, the Spectrum Analyzer trace will be *reduced* by 10 dB.

This value is not used if RF Level Offset is disabled (Off).

Reset to Defaults

All R8100 system settings are restored to the factory defaults.

Time

This selection sets the R8100 system clock in 24-hour notation. Use the numeric keypad and the Up/Down (▲ ▼) and Left/Right (◀ ▶) keys to make or change entries.

Date

This selection sets R8100 system date in month, day, year (MM.DD.YYYY) notation. Use the numeric keypad and the Up/Down (▲ ▼) and Left/Right (◀ ▶) keys to make or change entries.

Apply Date/Time Changes

This selection applies the time and date changes selected above to the R8100 system clock.

2.2.8.3 Network Settings for Remote Operation

The R8100 can be connected to a TCP/IP network for remote operation (see Section 3 REMOTE OPERATION) using the unit's Remote Front Panel option (R8-Remote). Communication over the network requires an IP address for the R8100. The analyzer uses a dynamic IP assigned using DHCP (Dynamic Host Configuration Protocol). Figure 3.2.9.3-1 shows the Network Settings setup submenu.

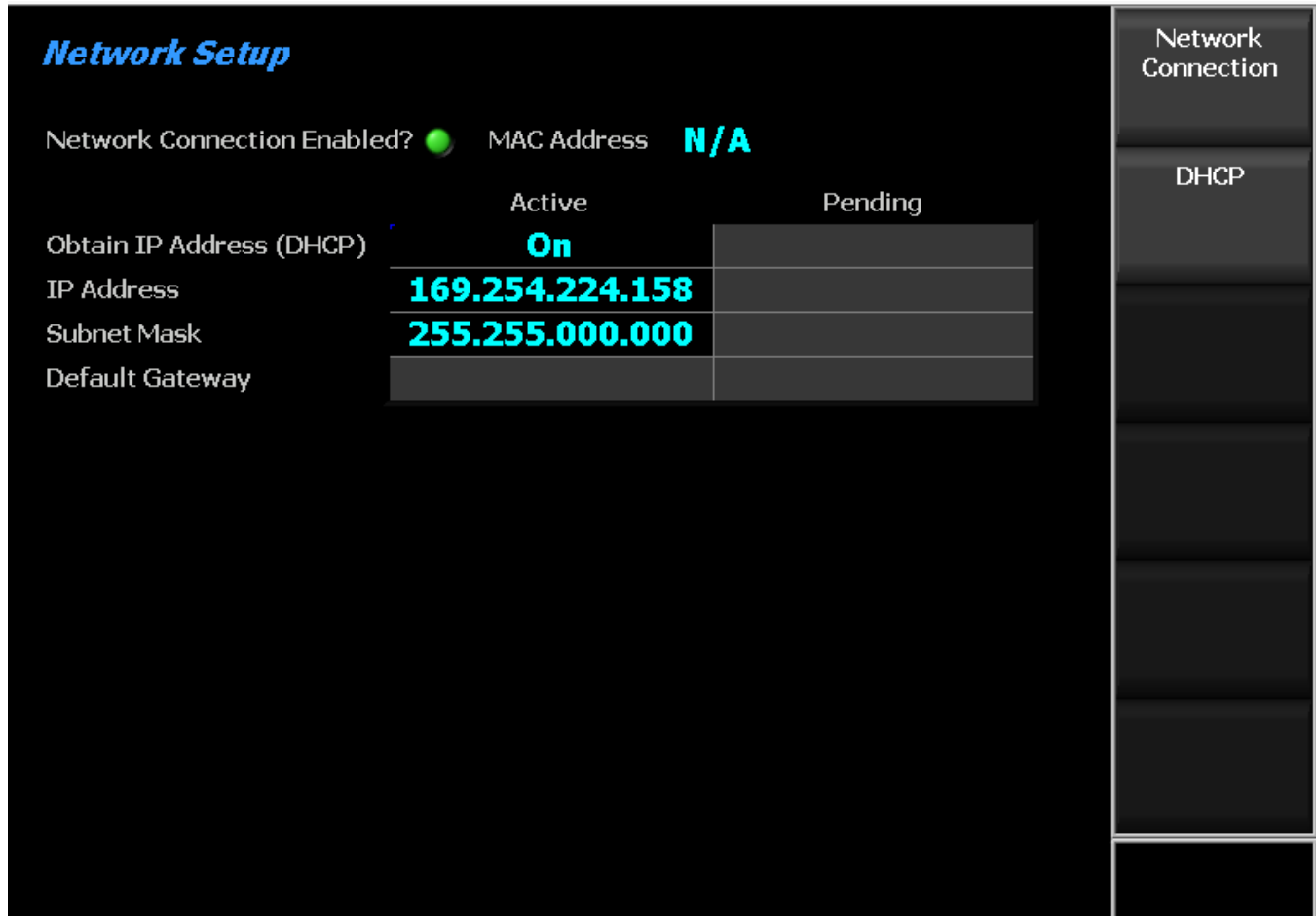

Figure 3.2.9.3-1 Submenu after pressing Network Setup soft key in the Settings menu

Network Connection

This key enables or disables the network connection for remotely operating the R8100. It is recommended that external security measures are taken when enabling the connection to prevent unauthorized access to the R8100. When the Network Connection is first enabled, DHCP is on by default.

Note: See Section 3 REMOTE OPERATION.

DHCP

This key enables DHCP (or Dynamic Host Configuration Protocol) by which an IP address is assigned to the R8100 during boot by a DHCP server on the Local Area Network. When the R8100 boots, it puts out a request on the Local Area Network for a DHCP server to assign it an IP address. The DHCP server has a pool (or scope) of IP addresses available. The server responds to this request with an IP address from

the pool, along with a lease time. Once the lease time for a given IP address lease has expired, the client must contact the server again and repeat the negotiation. If DHCP is set to off, then a static IP address must be entered for network control. **Note:** *When DHCP is on, the fields for IP Address, Subnet Mask, and Default Gateway are populated with their respective values from the DHCP server.*

IP Address (when DHCP is off)

Use this key to enter the IP address assigned to the R8100 by the network administrator.

Subnet Mask (when DHCP is off)

Use this key to enter the subnet mask address assigned to the R8100 by the network administrator.

Default Gateway (when DHCP is off)

Use this key to enter the Default Gateway address assigned to the R8100 by the network administrator. This is the address of the router that passes data outside the subnet to which the R8100 is attached.

Apply Network Changes

Pressing this soft key loads the network settings shown on the Remote Setup screen into the R8100 configuration memory.

2.2.8.4 Messages during R8100 operation

During operation the R8100 may display selective information on the message bar at the bottom of the screen between the test mode and the RF state. The messages relate the status of the analyzer during test transitions or alert the operator of a fault or condition requiring attention. Alerts are highlighted in yellow or red. Some messages may flash temporarily, and if more than one message exists, only the one reflecting the current condition is displayed. **Note:** *Messages that flash temporarily are not necessarily indicative of an issue with the R8100. Certain hardware, test, or signal transitions may require a short adjustment period for correct operation. Once resolved, the message will disappear and is of no concern for the operator. Errors requiring operator attention are displayed persistently until the test condition or fault is resolved.*

The R8100 keeps a running log of messages generated during the operational session. The log as shown in Figure 3.2.9.4-1 can be viewed using the Messages soft key. In the event of a fault in the R8100, these messages can provide diagnostic information to Freedom Communication Technologies support personnel. Message numbers in the five-thousands appear grey on the message bar; those in the six-thousands appear yellow; all others appear red.

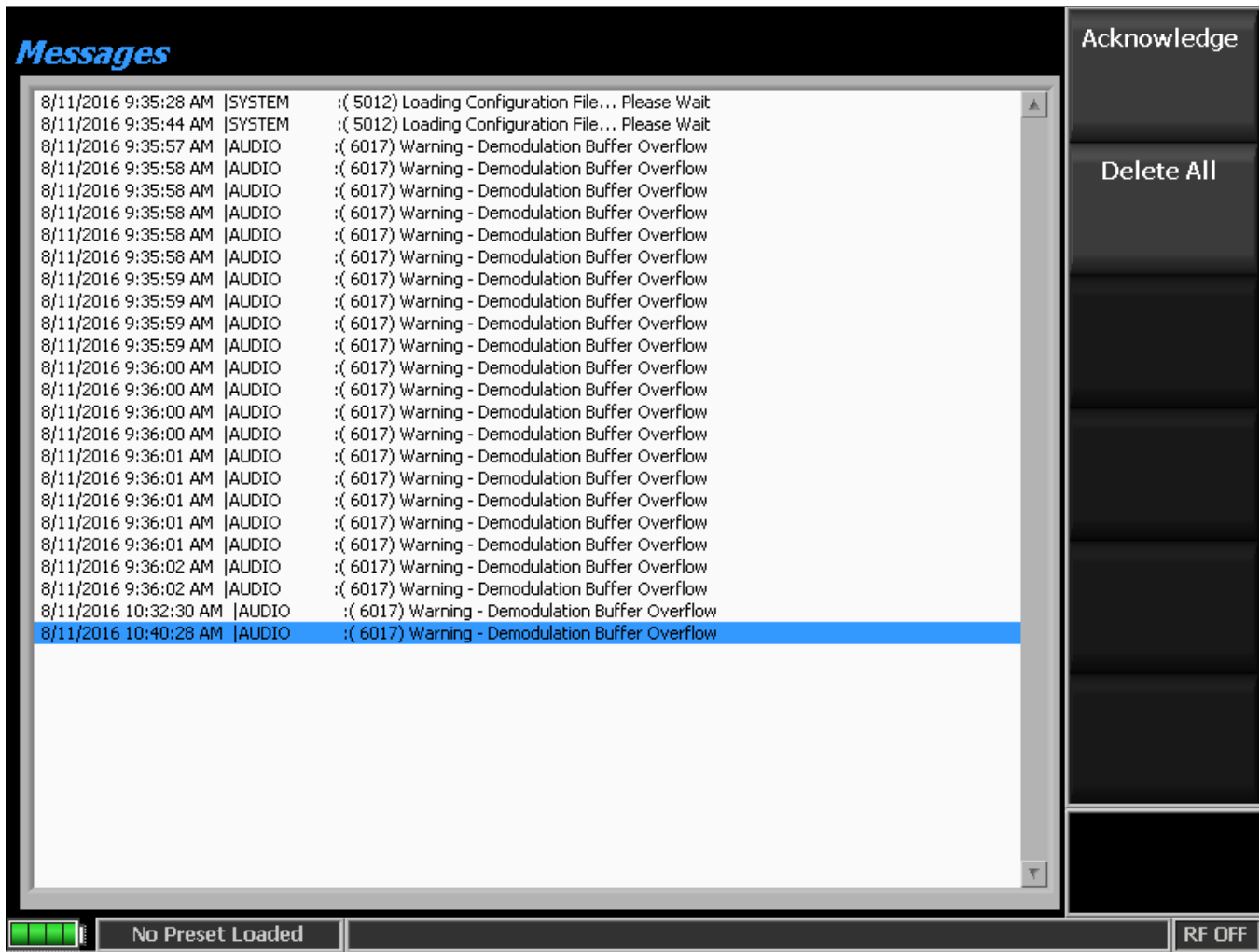

Figure 3.2.9.4-1 Submenu after pressing Messages soft key in the Settings menu

Acknowledge

Pressing this soft key removes the highlighted message from being displayed on the message bar. Use the spin knob or up/down arrow keys to select a message.

Delete All

Pressing this soft key removes all messages from the message log and message bar.

2.2.8.5 About

The About soft key loads a submenu that displays the current version of operational software on the R8100. This information is important when interacting with Freedom Communication Technologies personnel to resolve technical issues or determine if a firmware upgrade is required. Figure 3.2.9.5-1 shows the submenu, model, serial number, and current system firmware version after pressing the About soft key in the Settings menu. The system version uniquely identifies the combination of subsystem Versions and Protocols shown by their respective soft keys.



Figure 3.2.9.5-1 Submenu after pressing About soft key in the Settings menu

Protocols

Pressing this soft key displays the communication protocols and versions installed as options on the R8100 (Figure 3.2.9.5-2).

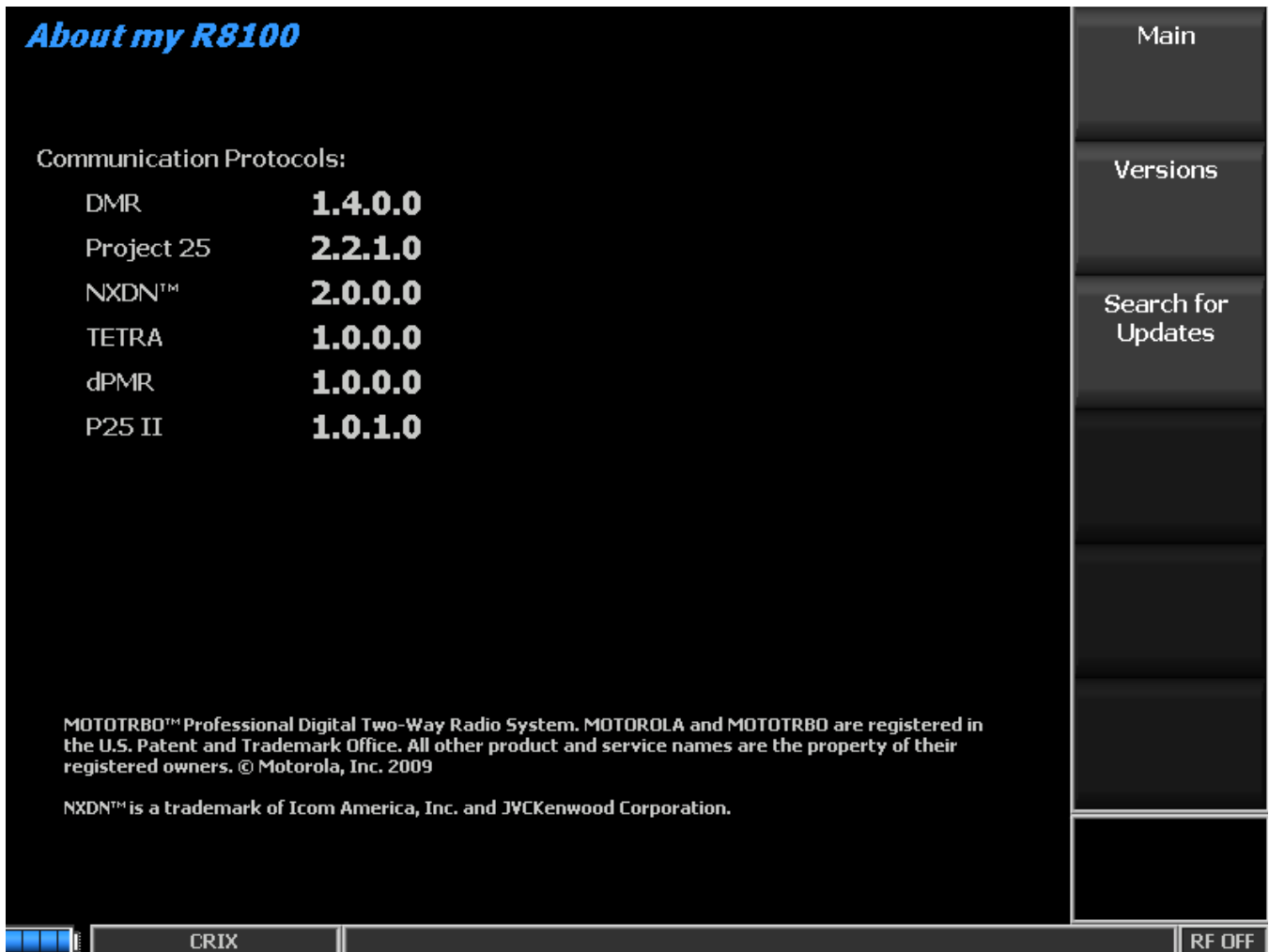

Figure 3.2.9.5-2 Settings/About/Protocols screen

Versions

Pressing this soft key displays the version of firmware components used in the core operation of the R8100 (Figure 3.2.9.5-3).

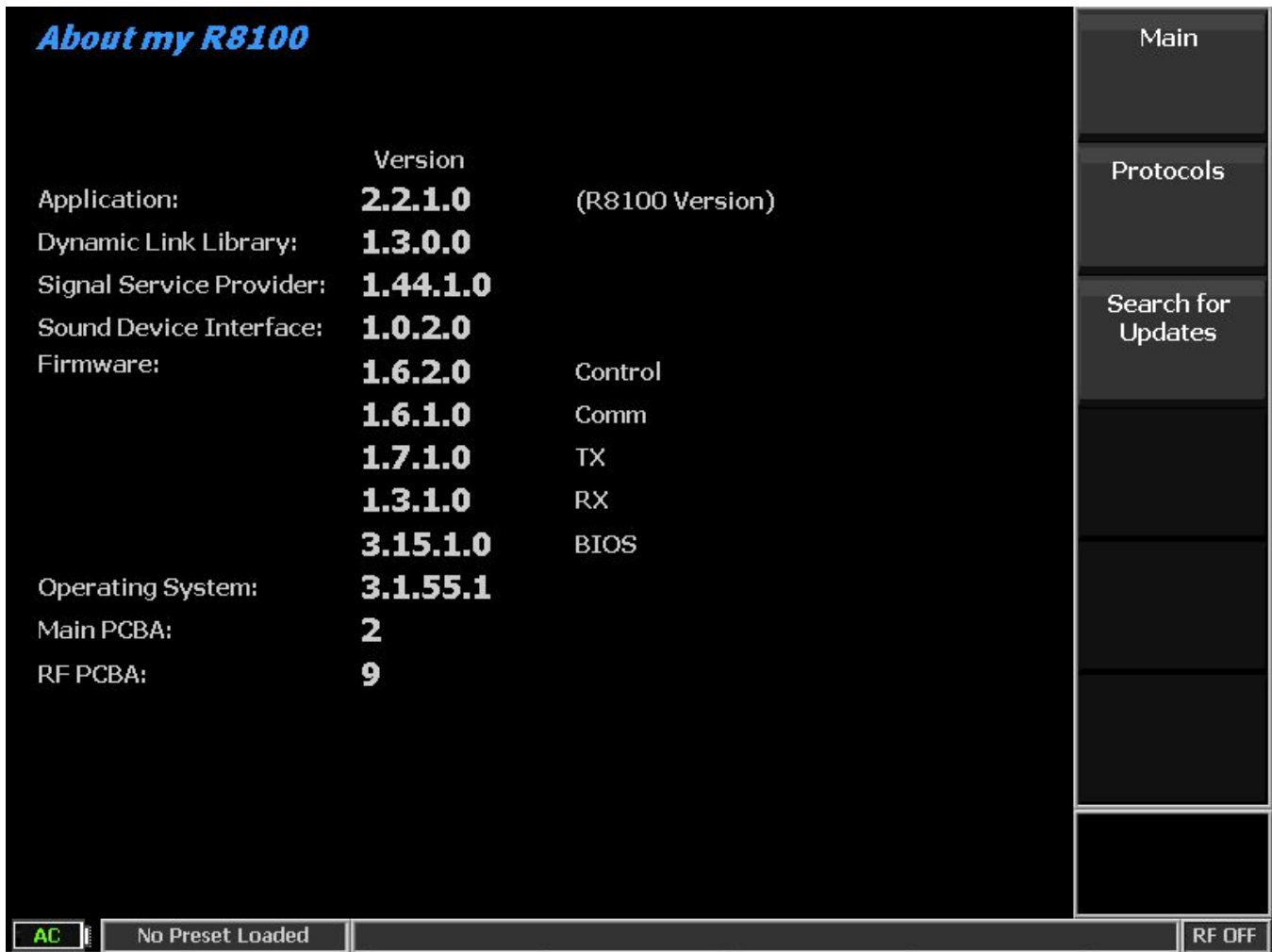

Figure 3.2.9.5-3 Settings/About/Versions screen

Search for Updates

This key initiates a search for firmware updates on a USB Flash Drive attached to any of the analyzer's USB ports (see Section 3.2.9.5.1).

2.2.8.5.1 Search for Updates

The R8100 firmware can be upgraded in the field using a USB Flash Drive. **Caution: firmware changes can significantly affect analyzer operation and should be performed carefully. An improperly executed firmware upgrade can render the analyzer inoperable. It is recommended that Freedom Communication Technologies support personnel be consulted and involved in firmware upgrades of the R8100.**

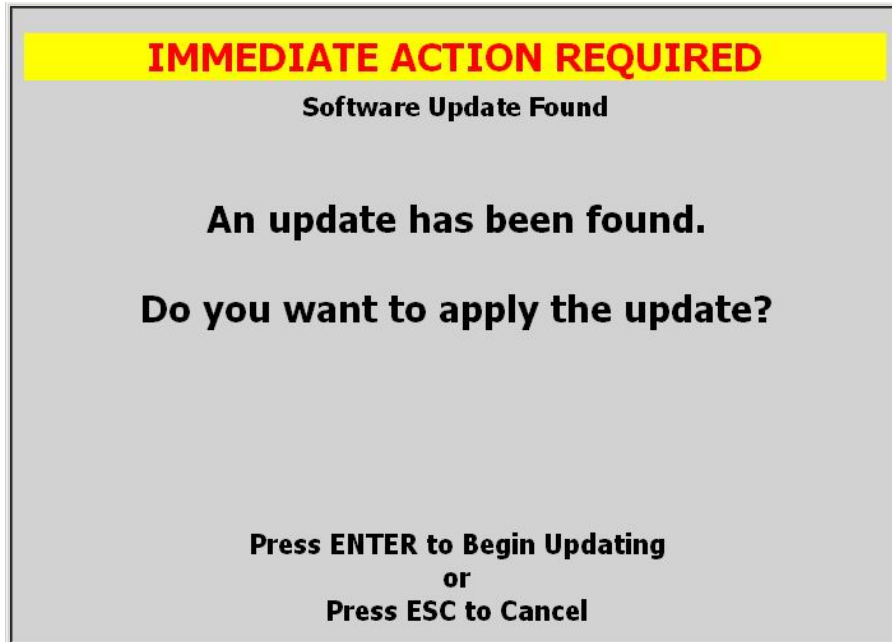

Figure 3.2.9.5.1-1 Alert screen as R8100 finds a valid update on a USB flash drive

Pressing the Search for Updates soft key initiates a search for firmware updates on a USB Flash Drive attached to any of the analyzer's USB ports. **Note:** *In order for the R8100 to recognize an attached Flash Drive, security features such as password protection or encryption must be disabled. Details of the firmware update process are not included in this manual since they tend to evolve with analyzer development. The latest and correct update procedure is provided with each firmware revision made available to users.*

2.2.8.6 Options

Pressing this soft key displays all the installed operating options on the R8100. These include enhanced features for the main R8100 system along with additional radio communication protocols or special test functions (see Figure 3.2.9.6-1). "Enter Option Key" provides a means for entering a unit-specific 16-digit number key to enable additional options purchased after the original order.

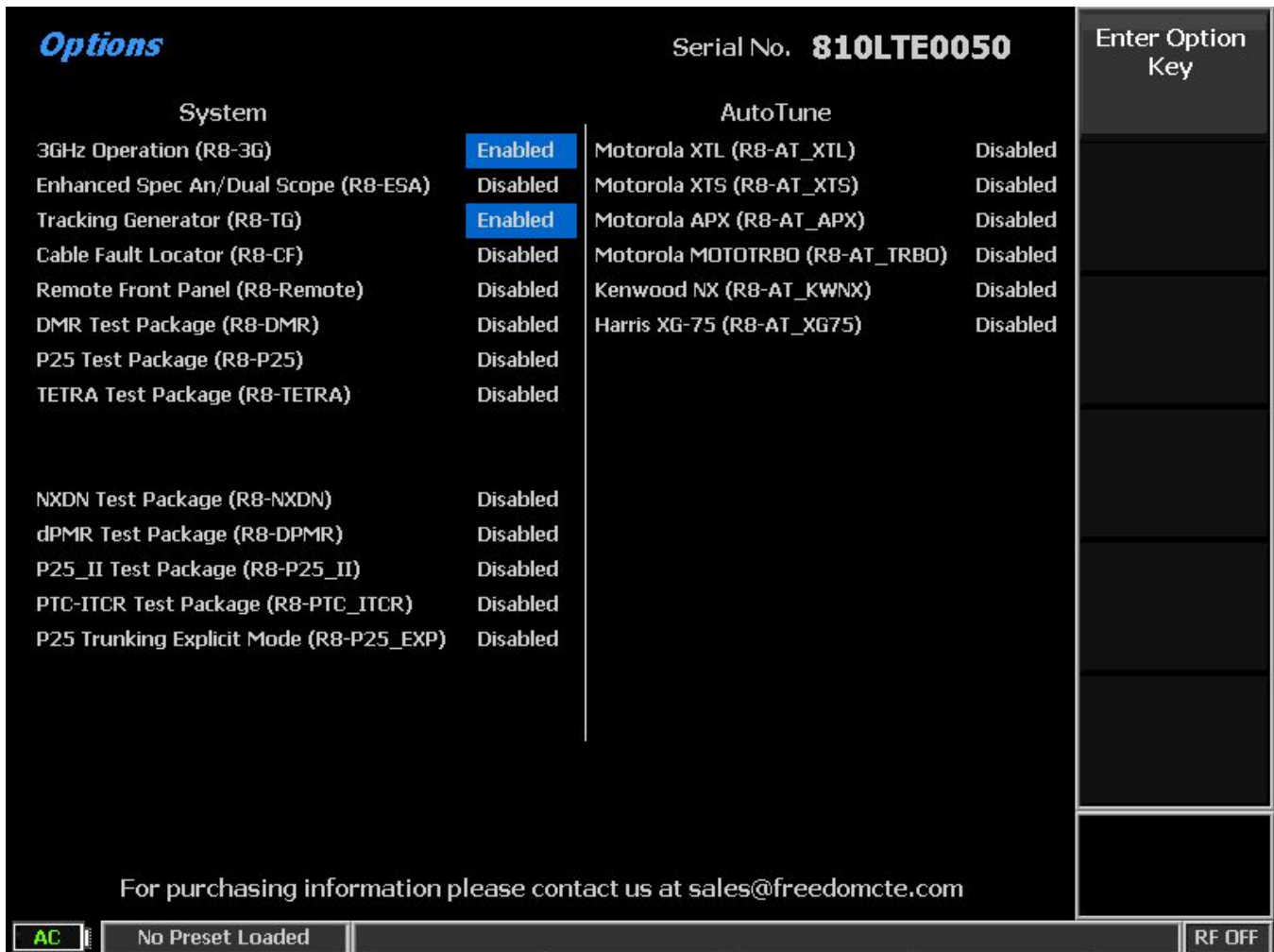

Figure 3.2.9.6-1 Submenu after pressing Options soft key in the Settings menu

2.2.9 Screen Capture

The R8100 can save display screen content in *.jpg (JPEG) file format to an attached USB flash memory drive. Screen captures are performed using a front panel key sequence. The R8100 can save the entire display screen or the content of individual Operating Zones. Each screen capture is initiated by first pressing the “Shift” key then a key corresponding to the display area being saved. File names are correlated to the display area being saved but are appended with a date timestamp in the form of yyyyymmdd_hhmmss. The key combinations are as follows:

Display area saved	Key sequence	File name
Main	Shift + 0	R8100yyyyymmdd_hhmmss.jpg
RF Zone	Shift + 1	RFZoneyyyyymmdd_hhmmss.jpg
Audio Zone	Shift + 2	Audioyyyyymmdd_hhmmss.jpg
Display Zone	Shift + 4 or 5	Displayyyyyymmdd_hhmmss.jpg
Meter Zone	Shift + 7 or 8	Meteryyyyymmdd_hhmmss.jpg

The flash drive can be inserted into any available USB slot on the R8100. Most flash drives have an activity light that flashes momentarily as the R8100 acknowledges the drive. Once the activity light stops flashing, the drive is ready to accept screen captures. **Note:** *There is always a risk that pre-existing files can be erased or corrupted. Therefore, it is highly recommended that the flash drive has no other critical files stored on the device. The R8100 will display a message before allowing files to be written to the USB flash drive.*

Once a screen capture is initiated, the R8100 displays a warning about potential corruption of existing files on the flash drive; the message appears once per operating session. The user is given the option of proceeding by pressing Enter or hitting the Esc key to cancel the action. For best assurance of file integrity, a waiting period of 30 seconds is recommended before removing the flash drive. Files are saved in folder location \R8100\ScreenShots\ created on the root directory of the flash drive (see Figure 3.10.-1).

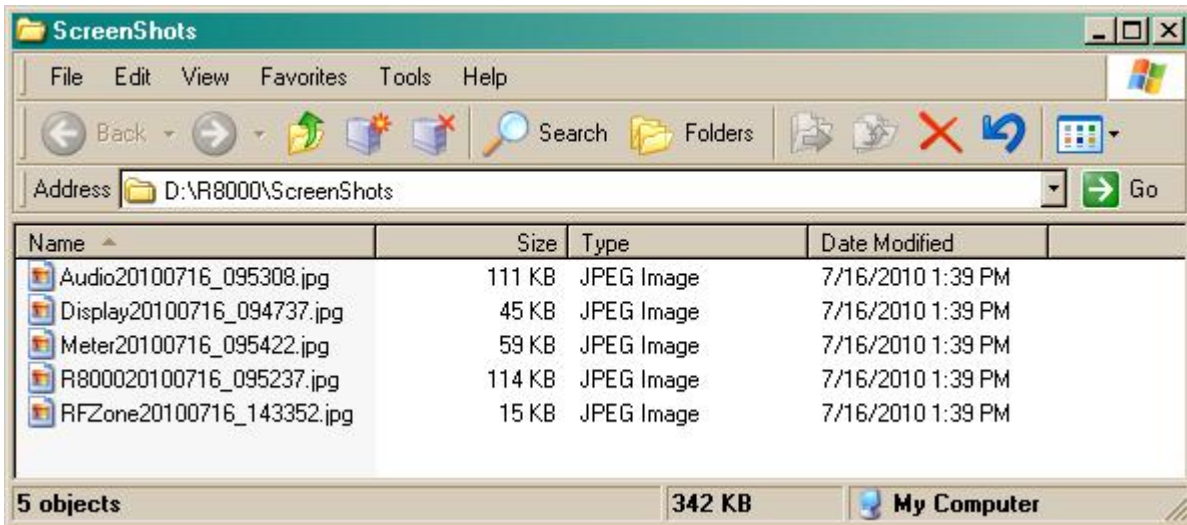

Figure 3.2.10-1 File folder location and names for R8100 Screen Captures

3 REMOTE OPERATION

This section describes the Remote Front Panel option (R8-Remote). For the command and response interface, see the R8100 Monitor & Control Programmer's Guide (CG-1110). Operation of the R8100 from another location is possible from a web browser via a TCP/IP network. Requirements for setup are as follows:

1. R8100 unit with AC power adapter
2. USB keyboard
3. Ethernet 10/100Base-T patch cable
4. Ethernet 10/100Base-T network
5. DHCP server (for operation over routed networks)
6. Network technician and/or administrator
7. Computer with network connectivity and administrative privileges
8. Internet Explorer 7 browser

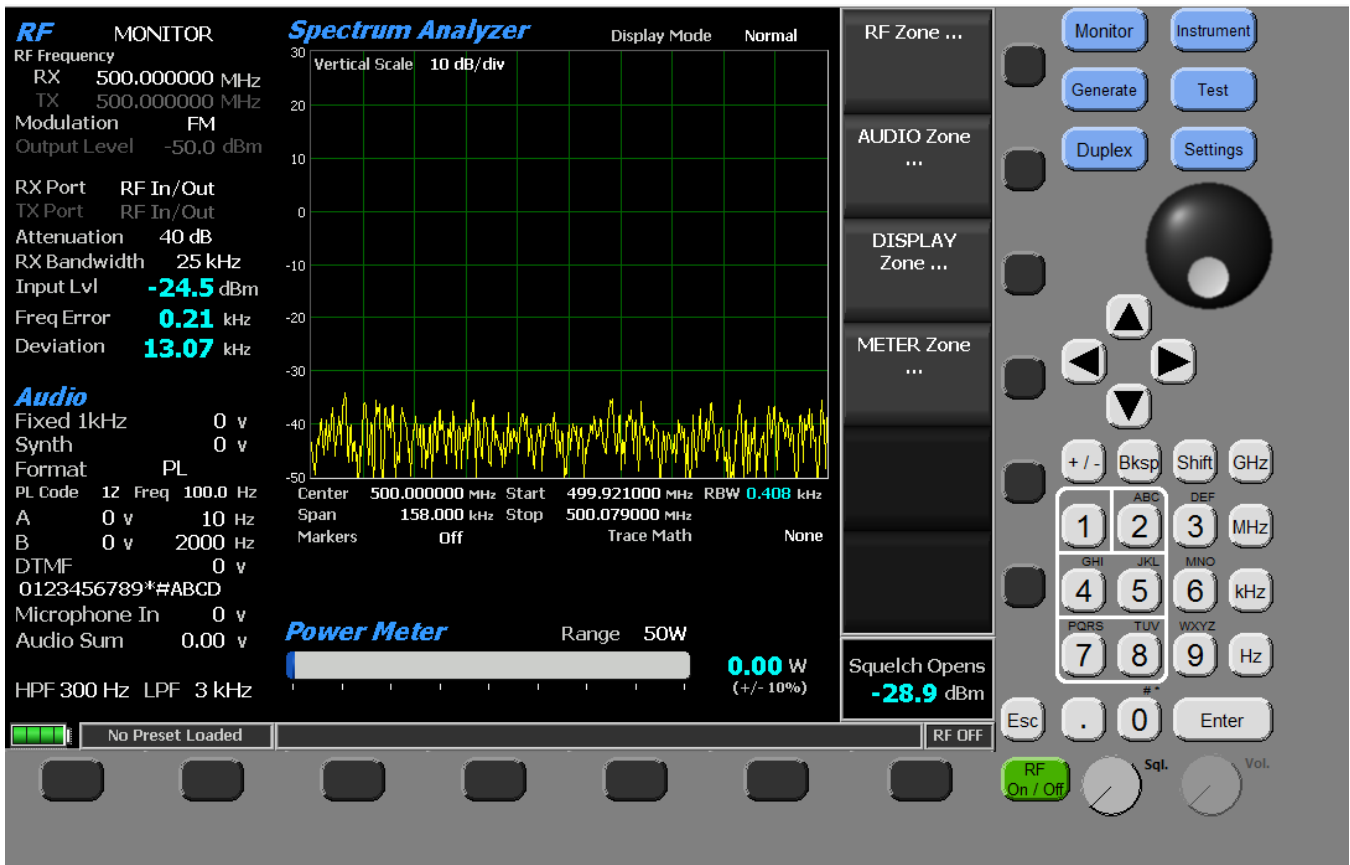

Figure 4-1 Remote Front Panel

3.1 BIOS Power-loss Setup

A BIOS setting must be changed for the unit to turn back on automatically after losing power in order to resume operation remotely. Initially, the R8100 is configured to remain off when power is restored. Follow the procedure below to change the power-loss behavior:

1. Turn off the R8100 power.
2. Connect a USB Keyboard to an R8100 USB port.
3. Hold down the keyboard's Delete key.
4. Turn on the R8100 power and continue to hold down the Delete key until prompted for a password.

CAUTION



Do NOT turn off the R8100 power during booting. If the Delete key was not depressed in time to start the BIOS SETUP UTILITY, allow the unit to finish booting, turn off the R8100 power, then try again.

5. At the "Enter CURRENT Password:" prompt, press the Enter key.
6. In the "BIOS SETUP UTILITY," use the right arrow key to select the Boot screen.
7. In the Boot screen, use the down arrow key to select the "Power Loss Control" item at the bottom of the "Boot Settings Configuration" section.
8. Press the +/- key to select the desired setting: Remain Off, Turn On, or Last State.

Note: *Last State causes the unit to turn back on as soon as power is restored after losing power. Turn On will cause the unit to turn on when power is restored even if it had been turned off when power was lost.*

9. Press the keyboard's F10 key.
10. At the "Save configuration changes and exit setup?" prompt, press the Enter key.
11. Disconnect the keyboard.

3.2 DHCP Server Setup

The DHCP server must assign an IP address for the R8100 to be entered into the Internet browser (see Section 4.4). Obtain assistance from network technician or administrator. Three common scenarios are listed below.

1. The DHCP server assigns the next available IP address to the R8100 for some duration (lease). The address is displayed by the R8100 on the Network Settings screen. The address may not be valid if the lease expires, or it may change if the unit reboots. Obtaining a new address from a remote location may be difficult, e.g. connecting to the DHCP server to obtain it.
2. (Recommended) The DHCP server assigns a fixed IP address for the specific physical address (MAC address) of the R8100. That IP address is always valid (e.g. 10.20.30.40).
3. The DHCP server assigns an IP address to the R8100. The address is given a fixed name by DNS. That name is always valid even if the IP address changes. Instead of entering the IP address into the browser, the name may be entered (e.g. unit1.company.com).

4. No DHCP server is present. The R8100 supports Automatic Private IP Addressing (APIPA), appropriate for simple networks that have only one subnet. With APIPA, if no DHCP server is available, the R8100 automatically assigns itself a private IP address. If a DHCP server later becomes available, the R8100 changes its IP address to one obtained from the DHCP server. Using APIPA, the R8100 assigns itself an IP address from a range reserved for authorized private class B network addresses (169.254.0.1 through 169.254.255.254), with a subnet mask of 255.255.0.0; it does not assign a default gateway. See <http://technet.microsoft.com/en-us/library/bb457118.aspx>.

3.3 Network Port Setup

The following procedure documents the configuration of the R8100 Communications System Analyzer network port:

1. Confirm the network cable is connected.
2. Turn the R8100 on (press the green power button on the front of the R8100 unit), and wait for the boot sequence to complete.
3. Press the Settings navigation button.
4. Press the “Network Setup” soft key (see Section 2.2.8.3 Network Settings for Remote Operation).
5. Press the “Network Connection” soft key.
6. Press the Enable soft key (to enable the network connection).
7. Read the alert (see Figure 4.3-1), and press Enter.

CAUTION



When the network connection is enabled, the R8100 may be controlled by other computers on the network without restriction. It is strongly recommended that the R8100 be protected from unauthorized access through the use of external security measures.

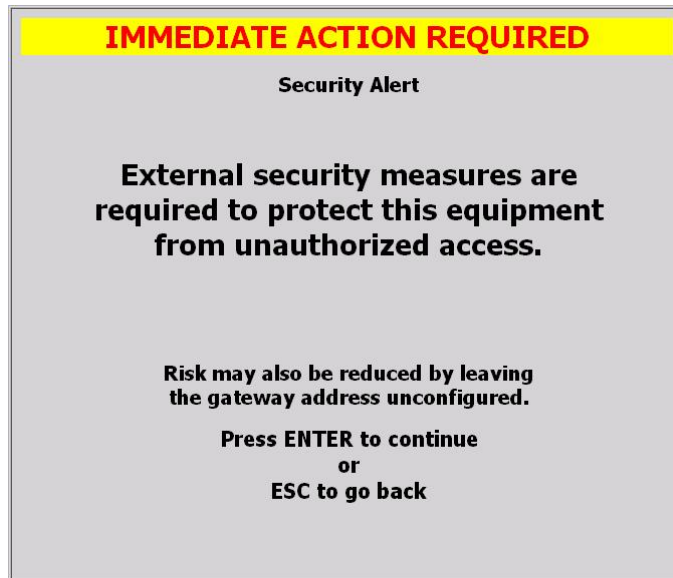

Figure 4.3-1 Network Connection Security Alert

8. Observe the green indicator below the configuration data fields that reads “Configuration In Progress.”
9. Wait several seconds for the configuration to complete. The R8100 remembers the previously set network settings.

Note: *If a DHCP server does not respond, the R8100 may display 000.000.000.000 values for the IP Address, Subnet Mask, and Default Gateway until APIPA values are displayed several more seconds later.*

10. DHCP must be On; it is On by default when the Network Connection is enabled for the first time. If it is Off, turn it On, and Apply Network Changes.

CAUTION



When DHCP is used to configure the network interface, the R8100 may be controlled by computers on local or external networks.

11. Record the IP Address configuration data field for use later (see Section 4.4).

3.4 Computer Setup

The R8100 provides a home page with hyperlinks for computer setup and remote use. Internet browser software (i.e., Internet Explorer 7) is required to access the home page. The internet address of the home page must be typed into the browser. The address consists of the R8100 IP address (see Section 4.3.10), the port number (8000), and the name of the home page (R8100.html). Examples:

1. `http://10.20.30.40:8000/R8000.html`
2. `http://unit1.company.com:8000/R8000.html` (if it was given a name)

Note: *If the web pages on the R8100 are changed by an R8100 update, local copies in the computer’s browser cache may have to be updated manually, e.g. by pressing the browser’s Refresh button.*

3.4.1 Setup

Third-party software must be installed on the computer to control the R8100. The software is National Instruments' NI LabVIEW Run-Time Engine 8.2.1 (Web Browser Only). Various links to the software are provided. [Setup via Intranet R8100](#) installs it from the R8100 (recommended); the other links require Internet access to install it from NI. Select the desired method to download the application supporting file, LVRunTimeEng.exe (~24MB). Either Open (run) the file directly, or Save it to computer and run from there. Perform the installation as directed. The default settings in the WinZip Self-Extractor window are acceptable; press the Unzip button to install the program. The program will be listed in the Control Panel, Add or Remove Programs.

Note: *To setup a remote computer that is not yet connected to an R8100, obtain NI LabVIEW Run-Time Engine 8.2.1 (Web Browser Only) with a computer that has Internet access: <http://joule.ni.com/nidu/cds/view/p/id/550> or <ftp://ftp.ni.com/support/labview/runtime/windows/8.2> For an operating system or language other than Windows/English [click here](#).*



CAUTION

It is recommended that only one browser tab or window be used to access the R8100 in order to reduce the potential of losing control of the access license for the single point of control.

3.4.2 Control

One client may view the R8100 display and control the interface with a computer mouse (see Figure 4-1). Controlling the unit remotely does not prevent control locally and vice versa. Java, ActiveX, and third-party software are required. Minimum network bandwidth is 1.5MB/s.

3.4.2.1 Software Requirements

1. Allow Java scripts to run.
2. Allow ActiveX controls to run.
3. Install 3rd-party software (see Section 3.4.1 Setup).
4. Display resolution 1024x768 pixels (minimum).

3.4.2.2 Interface Differences

1. The graphical update rate is slower and depends on network latency.
2. Calibration, which requires that RF connections be removed, is not supported.
3. Updates, which require that a USB drive be inserted, are not supported.
4. The following user-interface items are not supported: microphone, speaker, volume knob, squelch LED, and power button.

3.5 Disable Remote Access

1. Press the Settings navigation button.
2. Press the “Network Setup” soft key (see Section 2.2.8.3 Network Settings for Remote Operation).

3. Press the “Network Connection” soft key.
4. Press the Disable soft key.

3.6 Verification / Troubleshooting Information

1. The R8100 responds to ICMP ping. Default gateway connectivity questions are best resolved by confirming that both local and remote pings to the R8100 succeed.
2. The Remote Front Panel application communicates with the R8100 via TCP port 8000. If the network is protected by one or more firewalls, ensure that the network configuration does not block access to the R8100.
3. R8100: Network Configuration Failed (6002) message when applying network changes. The DHCP server may have responded late. The interface could be functional afterwards.
4. R8100: Network Setup, APIPA IP Address is blank or zeros when the network connection is enabled. First, wait a minute. If the condition persists, then connect a live network cable to the Ethernet port, disable the network connection, restart the unit, and try again.
5. Browser: Requested VI is not loaded into memory on the server computer. The R8100 Remote Front Panel (R8-Remote) option may not be enabled; verify by pressing the R8100 Settings hard key then the Options soft key. If the R8-Remote option is enabled, the R8100 Remote Front Panel Control page may have been loaded or refreshed too early. Wait until the R8100 has finished starting.
6. Browser: Remote panel connection refused by specified server: Make sure LabVIEW Web Server is enabled on specified server. The R8100 Remote Front Panel Control page may have been loaded or refreshed too early. Wait until the page has finished loading.
7. Browser: Any of the following messages may occur as a result of the R8100 losing power, being turned off, being disconnected from the network, the network connection being disabled, or network settings being changed. Verify R8100 power and settings then try again.
 - Downloading panel. 0.00% of 0 bytes
 - Remote panel connection is closed
 - Fatal error occurred during operation, closing connection
 - Server connection has been broken
 - Server #.#.#.# has disconnected client for unknown reason
8. Browser: Issues encountered when using a non-Internet Explorer 7 browser should first be confirmed by installation of Internet Explorer 7 to ensure they are not browser related.

4 TEST APPLICATIONS

This section contains information on typical test setups to perform some of the more common radio tests using the R8100 Series Communications System Analyzer. Freedom Communication Technologies takes no responsibility for application accuracy, applicability, or safety. Always refer to transceiver's service manual for recommended test methods and specifications.

4.1 FM Transmitter Testing

The R8100 has extensive capability for evaluating the performance of FM transmitters. However, detailed instructions for the wide variety of transmitter types are outside the scope of this manual. This section will outline basic FM transmitter testing and focus on fundamental items of importance such as transmit power, carrier frequency, and voice quality measurements.

4.1.1 Basic FM Transmitter Testing – initial setup

Refer to Figure 5.1.1-1. Connect the analyzer's RF I/O port to the RF output of the transmitter under test. Connect the analyzer's Mod In/Out jack to the microphone audio input of the transmitter under test. Access to the microphone input is often provided through a special interface connector on the radio used for testing purposes. Refer to radio service manual.



CAUTION

For transmit power output measurements, connect the transmitter under test only to the analyzer's RF I/O port. Do not connect it to the ANTENNA port. The ANTENNA port is used for low level signals or those captured with an antenna during "Off-The -Air" reception.



Figure 5.1.1-1 Setup for FM Transmitter testing

4.1.2 Transmit Power, Frequency, and Frequency Deviation Measurements

Place the R8100 in Monitor Mode by pressing the Monitor front panel hard key. Press the RF Zone soft key, and set the Monitor Frequency to that of the radio under test and the Modulation Type to FM. For best accuracy, set the Bandwidth just wide enough to cover the channel spacing allocated to the radio under test.

To eliminate the background noise from the R8100 when the transmitter is not keyed, adjust the squelch control appropriately. With the volume control set to a comfortable listening level, turn the threshold control clockwise to just quiet the R8100 receiver. (See Front Panel Control Knobs.) For low-power transmitters, it may be necessary to reduce the RF attenuation value to un-squelch the monitor when the transmitter is keyed. Too high of an attenuation setting or too tight a squelch setting also inhibits the frequency error reading. Deviation and frequency error measurements require sufficient signal level from the radio to fully quiet the analyzer's receiver. Accuracy is best when the signal levels are 10 dB or higher than that required to quiet the receiver. Use good quality cable of minimum length to prevent cable-loss, which can be a significant factor in RF power measurements, especially at UHF and above.

Key the transmitter and read the power ("Input Lvl"), frequency error ("Freq Error") and deviation ("Deviation") in the RF Zone section of the R8100 main screen. Refer to radio service manual to determine if power, frequency, and deviation are within specified limits and if any adjustments are required.

4.1.3 Modulation Measurements

Place the R8100 in Monitor Mode by pressing the Monitor front panel hard key. Press the RF Zone soft key, and set the Monitor Frequency and Modulation Type to match that of the radio under test. For best

accuracy, set the Bandwidth just wide enough to cover the channel spacing allocated to the radio under test.

CTCSS (Continuous Tone-Coded Squelch System) test

Enable the CTCSS Mode on the radio (called PL or DPL on Motorola units). Enable the 300 Hz low pass filter on the R8100 to prevent external pickup in the microphone from causing deviation errors. Key the transmitter, and read the deviation of the PL/DPL tone. Refer to the radio's service manual to determine if an adjustment is required.

Voice frequency modulation and quality test

In the R8100 Audio Zone, set the High Pass Filter to 300 Hz and the Low Pass Filter to 3 kHz. Set the Fixed 1 kHz Mode to Continuous. Set the Fixed 1 kHz level at the R8100 Mod In/Out connector to the minimum required for proper microphone sensitivity as specified in the radio service manual. **Note:** *The voltage levels displayed in the Audio Zone are peak open circuit voltages. Verify proper microphone sensitivity by reading the deviation and comparing to the service manual specification to determine if adjustments are needed.*

Set the Fixed 1 kHz level at the R8100 Mod In/Out connector to the maximum required for proper microphone sensitivity as specified in the radio service manual. Navigate to the R8100 Meter Zone, and select the Internal Distortion meter. Read the percent distortion and compare to the service manual specification to determine if adjustments are needed.

4.1.4 Off-The-Air Measurements

Place the R8100 in Monitor Mode by pressing the Monitor front panel hard key. Press the RF Zone soft key, and set the Monitor Frequency and Modulation Type to match that of the two-way radio or transmitter under test. For best accuracy, set the Bandwidth just wide enough to cover the channel spacing allocated to the radio under test. In the R8100 Audio Zone, set the High Pass Filter to 300 Hz and the Low Pass Filter to 3 kHz.

Connect the supplied whip antenna to the R8100 ANTENNA port. Connect a dummy RF load, or hook the radio's working antenna into the antenna port of the radio. Adjust the squelch control to ensure the incoming radio signal will un-squelch the monitor. Otherwise, rotate the knob fully counter-clockwise (squelch off), and lower the volume if the background noise is excessive.

Key the radio, or activate the transmitter being monitored. Deviation and frequency error measurements require sufficient signal level to fully quiet the analyzer's receiver. Accuracy is best when the signal levels are 10 dB or higher than the receiver's quieting threshold. Read the signal level ("Input Lvl"), frequency error ("Freq Error"), and deviation ("Deviation") in the RF Zone section of the R8100 main screen.

4.2 FM Receiver Testing

The R8100 has extensive capability for evaluating the performance of FM receivers. However, detailed instructions for the wide variety of receiver types are outside the scope of this manual. This section will outline basic FM receiver testing and focus on fundamental items of importance such as receiver sensitivity, frequency accuracy, audio distortion, and squelch sensitivity.

4.2.1 Basic FM Receiver Testing – initial setup

Refer to Figure 5.2.1-1. Connect the analyzer's RF I/O port to the RF input of the radio or receiver under test. Connect the radio's speaker/audio output to the analyzer's Meter In port. Access to the speaker/audio

output is often provided through a special interface connector on the radio used for testing purposes. Refer to radio service manual.

CAUTION 

The analyzer's Meter In port is unbalanced (ground referenced). On some radios, grounding the speaker output will damage the audio circuitry. Use an appropriate interface to measure balanced or DC powered audio circuits with the Meter In port of the R8100. Typically, this requires the use of an isolation transformer which is an optional R8100 accessory.

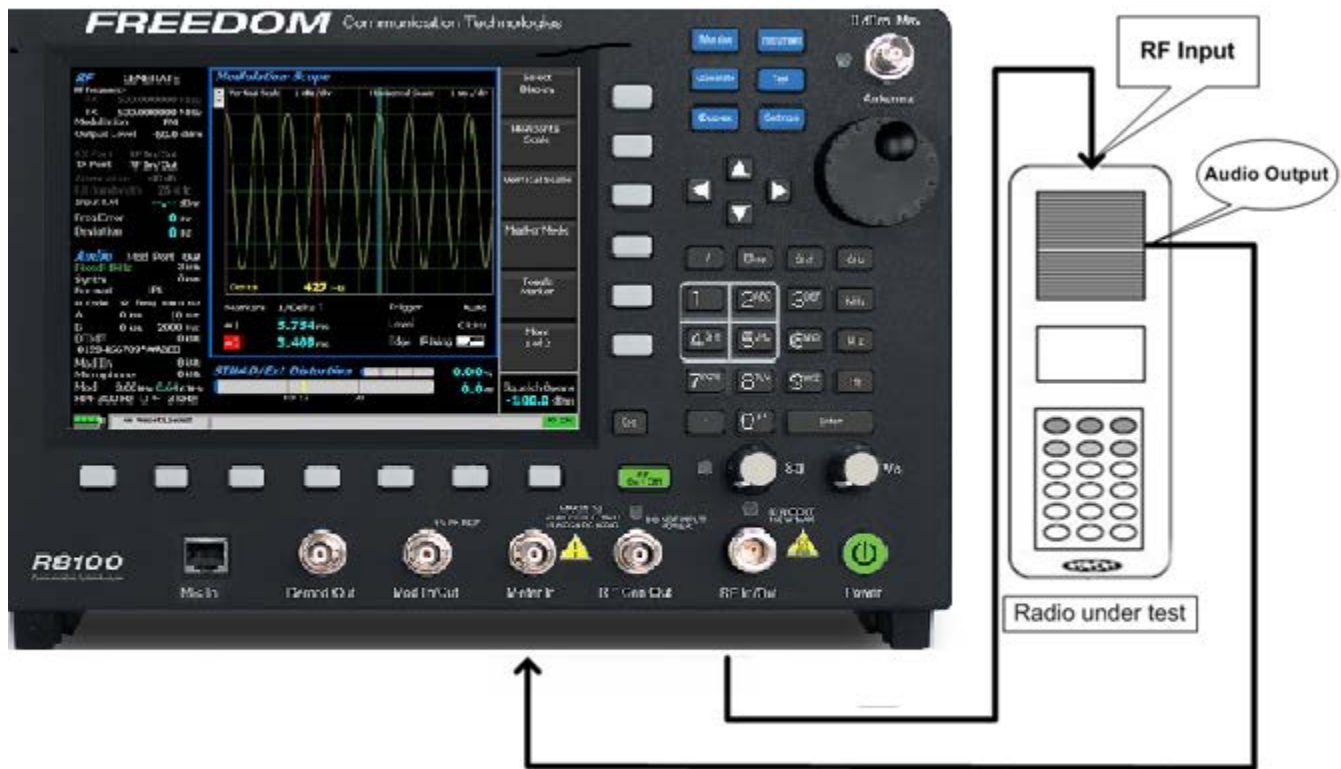

Figure 5.2.1-1 Setup for FM Receiver testing

Place the R8100 in Generator Mode by pressing the Generate front panel hard key. Press the RF Zone soft key, and set the Generator Frequency to match that of the radio under test and the Modulation Type to FM. Set the Bandwidth just wide enough to cover the channel spacing allocated to the radio under test.

For initial setup, set the RF output level to at least 30 dB above the receiver's sensitivity threshold. A starting level of -80 dBm is recommended. Navigate to the Audio Zone, and set the Fixed 1 kHz Mode to Continuous. Set the Fixed 1 kHz Level to 60% of the system deviation for the receiver. For narrowband two-way radios, a typical setting is 3 kHz. Page through the submenu, and set the High Pass Filter to 300 Hz and the Low Pass Filter to 3 kHz.

Navigate to the Meter Zone, and select the AC Volts meter. Adjust the radio for rated power output by calculating the voltage needed across the load resistor/speaker in use. Adjust the radio volume until the meter reads the calculated voltage.

Navigate to the Display Zone, and select the Oscilloscope display. Adjust the vertical and horizontal settings, and observe the recovered audio sine wave from the receiver.

4.2.2 Receiver Distortion Measurement

Navigate to the Meter Zone, and select the External Distortion meter. Read the displayed distortion in percent, and compare the radio's service manual specification to determine if any repairs or adjustments are needed.

4.2.3 SINAD Measurement

Select the SINAD meter, and note the bar graph and digital indication in dB. It may be necessary to adjust the radio's volume until the signal level is within the meter's range. Navigate to the RF Zone, and adjust the Generator level until the reading averages 12 dB. Note the RF level required for a 12 dB SINAD, and compare to the radio's specification. Typical values for two-way radios range from -100 to -120 dBm. **Note:** *For best results, set the baseband audio filters of the analyzer to achieve a bandwidth no wider than necessary for the modulation frequency range of the radio under test. Ex: two-way voice is typically 300 Hz to 3 kHz. This minimizes noise in the measurement and provides smoother readings.*

4.2.4 Modulation Acceptance Bandwidth

Set the radio's volume control to 10% of its rated output. Adjust the R8100 RF output level 6 dB above that needed for 12 dB SINAD as determined in 5.2.3 (a 6 dB increase is double the RF voltage). Increase the deviation level until the SINAD meter returns to 12 dB. Read the deviation and compare to the radio's specification.

4.2.5 Receiver Sensitivity Testing (20 dB Quieting)

Place the R8100 in Monitor Mode to remove input signal from the radio. In the Meter Zone, select the AC Voltmeter. Make certain the radio is un-squelched, and adjust the volume control to feed noise to the analyzer at approximately $\frac{1}{4}$ the rated audio power. Record the noise reading in dBm.

Switch the R8100 to Generate Mode, navigate to the Audio Zone, and turn off all modulation. In the RF Zone, adjust the RF output level until the noise reading on the AC voltmeter is 20 dB less than the recorded value. Refer to the radio's service manual to determine if any adjustments or repairs are needed.

4.2.6 Squelch Sensitivity Test

Threshold Squelch Sensitivity

Place the R8100 in Monitor Mode to remove input signal from the radio. Disable the radio's PL/DPL squelch if provided. Carefully adjust the radio's squelch control to the point where the receiver just quiets and no further.

Switch the R8100 to Generate Mode, navigate to the Audio Zone, and turn off all modulation. In the RF Zone, adjust the RF output level below that required to un-squelch the radio's receiver. Gradually raise the level until the receiver just un-squelches. This is the threshold squelch sensitivity of the radio.

Tight Squelch Sensitivity

Repeat the test after adjusting the radio's squelch to the tight setting; this is either a maximum or pre-determined higher setting used to reject weak noisy signals. Refer to the radio's service manual to determine if any adjustments or repairs are needed.

PL/DPL Squelch Sensitivity

With the R8100 in Generate Mode, navigate to the Audio Zone. Change the Synth Format to PL or DPL, and enter the appropriate code for the radio under test in the PL or DPL Table submenu. See Table B-3 and B-5 in Appendix B for standard codes used in PL/DPL enabled systems. Turn the Synth Mode to On, and adjust the level to provide a 750 Hz deviation or that specified in the manufacturer's specifications.

Enable the radio's PL/DPL Squelch Mode, and fully open the squelch control (minimum setting or fully counter-clockwise on many radios). In the RF Zone, gradually raise the RF output level until the receiver just breaks or opens the squelch. Refer to the radio's service manual to determine if any adjustments or repairs are needed.

4.3 Cable Fault Testing

The R8100 Cable Fault Locator is used with the Cable Fault Option Kit to determine distance to a fault or termination mismatch in RF cables. The kit contains a resistive RF power splitter, a 50 Ohm load, and two male BNC cables for connecting the splitter to the R8100 analyzer. Figure 5.3-1 shows the connections to the analyzer.

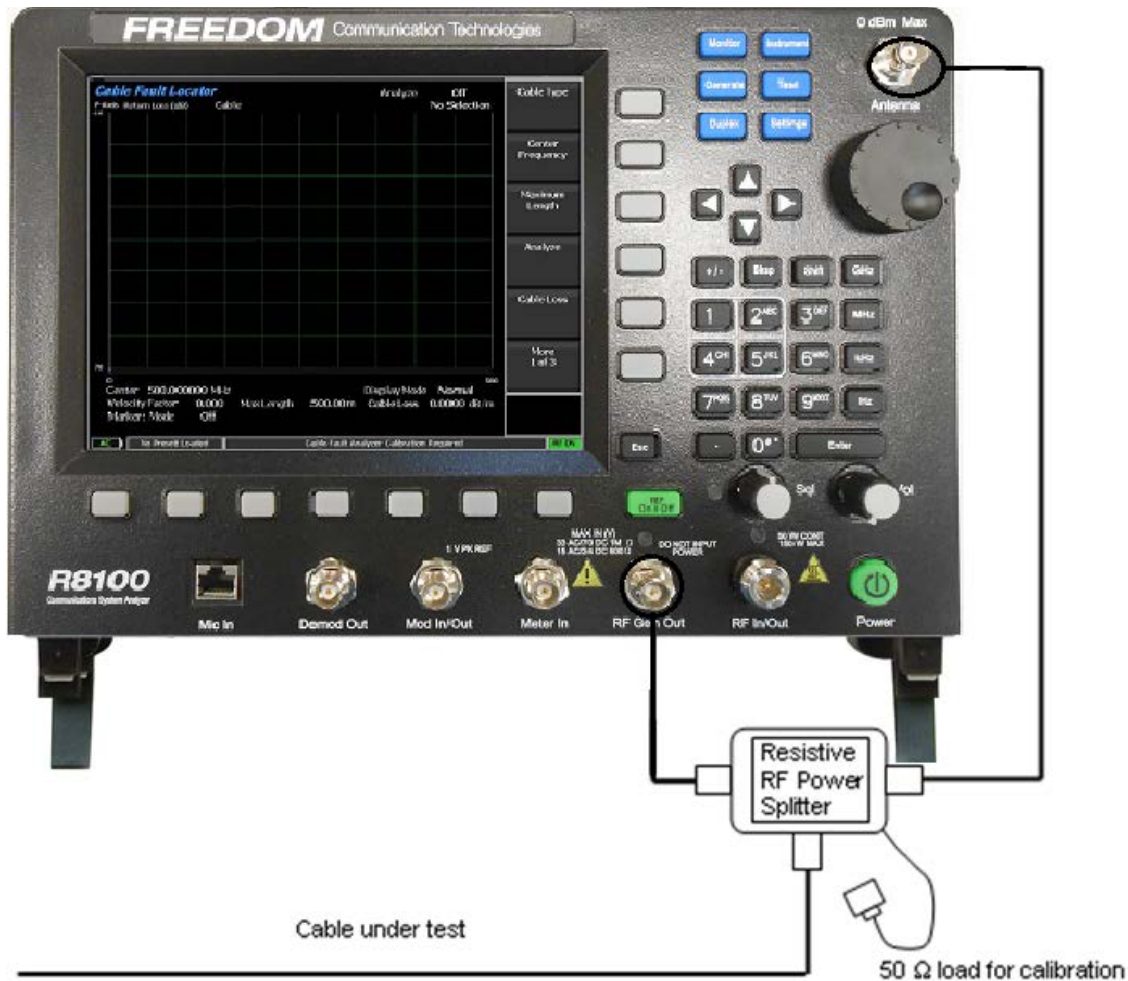

Figure 5.3-1 Connections for Cable Fault testing

4.3.1 Cable Fault Locator Setup and Operation

For accurate results, the R8100 Cable Fault Locator must be configured with four cable parameters before testing. These are the Center Frequency, Maximum Length, Cable Loss, and Velocity Factor.

Center Frequency

The Cable Fault Locator analyzes a cable by measuring signal reflections as the R8100 sweeps its generator over a band of frequencies. The Center Frequency defines the center of the band and is ideally the center of the cable's operational frequency.

Maximum Length

This is the maximum expected length of the cable with an additional safety factor. Underestimating the length can cause imperfections to appear at the wrong location. Overestimating reduces the distance resolution.

Cable Loss

The Cable Loss defines the power lost per unit length of cable. The return loss measurement is compensated by this factor to ensure accuracy.

Velocity Factor

Velocity Factor is the relative velocity of the RF electromagnetic wave traveling through the cable as compared to c , the velocity of light. Typical values range between 0.66 and 0.84.

Procedure

Start the Cable Fault Locator by pressing the Instrument key. Select “Cable Fault Locator...” from the vertical submenu; the operator may have to first choose “More 1 of 2.” The display should appear as shown in Figure 5.3.1-1.

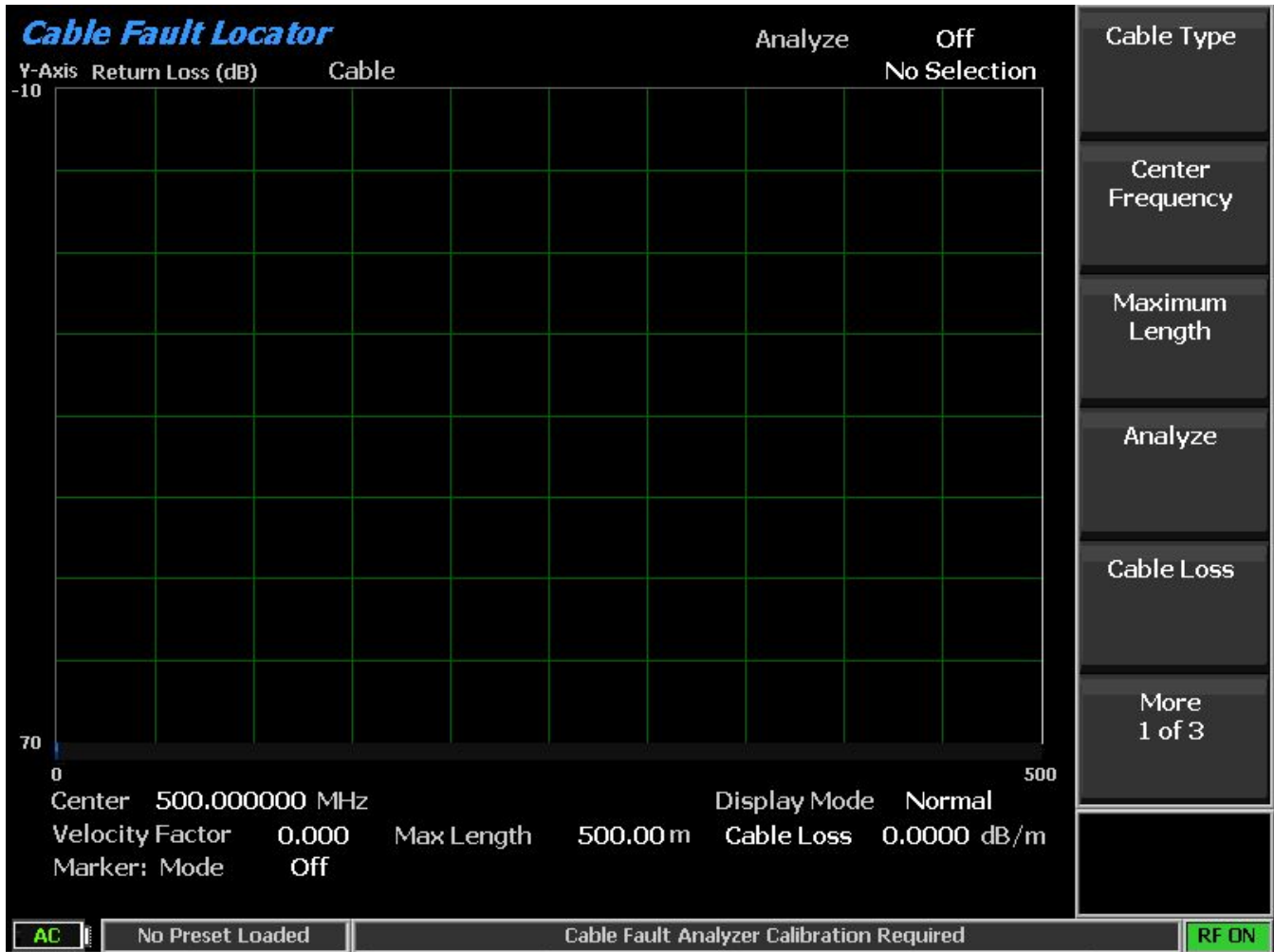

Figure 5.3.1-1 Cable Fault Instrument Display

Enter the Center Frequency, Maximum Length, Cable Loss, and Velocity Factor for the cable under test.

Note: For frequent tests or multiple frequencies, it is advantageous to save these parameters using the “Add Cable Type” soft key function. This allows custom parameter entry for a user-defined cable not on the standard selection list. A submenu allows entering a “Cable Description” and associated cable specifications, including attenuation factors for three separate frequencies. “Next” advances the menu to each successive Frequency/Nominal Attenuation entry, and “Back” returns to the previous entry menu. Once the third frequency point is populated with data, “Save New Cable” stores the entry in R8100 memory. The user-defined cable will now appear in the “Cable Type” selection window.

Connect the Power Splitter to the R8100 as shown in Figure 5.3-1, but leave the Cable Under Test disconnected.

Note: *The Power Splitter has a symmetrical internal configuration, so connections from the R8100 and cable under test can be made to any port on the Power Splitter. (In other words, all Power Splitter ports are interchangeable.) However, it may be physically convenient to connect them as follows: R8100 RF Gen Out to Power Splitter port 1, R8100 Antenna to Power Splitter port 2, Cable under test to Power Splitter port 5.*

Connect the 50 Ohm load to the open port on the Power splitter, and start a calibration sweep by pressing “Analyze” then “Calibrate.” The calibration sweep takes approximately one minute to complete. **Note:** *Whenever the Center Frequency, Maximum Length, or Velocity Factor are changed, the Cable Fault instrument will force a recalibration before performing an analysis sweep.*

Remove the 50 Ohm load, and connect the cable to be tested; choose either Single Sweep or Continuous in the “Analyze” submenu. Each sweep takes approximately one minute to complete, and the display will update with a plot of return loss vs. distance.

4.4 ITCR Interoperable Train Control Radio (Positive Train Control)

Positive train control (PTC) is a system of functional requirements for monitoring and controlling train movements.

System Highlights:

- Train separation or collision avoidance
- Line speed enforcement
- Temporary speed restrictions
- Rail worker wayside safety
- Regulation of train separation
- Avoidance of train-to-train collisions at track crossover locations
- Enforcement of continuous line speed including temporary speed restrictions
- Protection of rail worker wayside safety zones
- Regulation of out-of-service grade crossings
- Prevention of a train running over a mainline switch set in the wrong position

PTC system involves two basic components:

- A speed display and control unit on the locomotive
- A method to dynamically inform the speed control unit of changing track or signal conditions.^[21]

Optionally, three additional components may exist:

- An on-board navigation system and track profile database to enforce fixed speed limits
- A bi-directional data link to inform signaling equipment of the train's presence
- Centralized systems to directly issue movement authorities to trains

References

<http://www.fas.org/sgp/crs/misc/R42637.pdf> Congressional Research Report and Overview

<http://www.fra.dot.gov/Page/P0621> DOT overview

Meteorcomm PTC220_Radio_Transmitter_and_Receiver_Test.pdf Example of how to control the radio in test conditions.

Please consult the radio's manufacturer for instructions on how to enable control of the radio under test conditions.

Freedom R8100 PTC Test Option

PTC testing on the R8100/R8000 supports Physical layer testing of ITCR PTC radios used in the I-ETMS® (Interoperable Electronic Train Management System).

Modulation type: Pi/4 DQPSK

Symbol rates: 16 ksps (Full rate) and 8 ksps (Half rate)

Measurements include:

- Power in RMS and PEP
- Frequency Error
- Error Vector Magnitude
- IQ Imbalance
- Phase Error
- Magnitude Error
- BER testing while ratio in test mode
- PN9 test pattern with built in FEC

Displays available in PTC testing on the R8100/R8000:

- Circular Constellation
- Linear Constellation
- Power profile with adjustable time scale
- Distribution diagram
- Eye Diagram

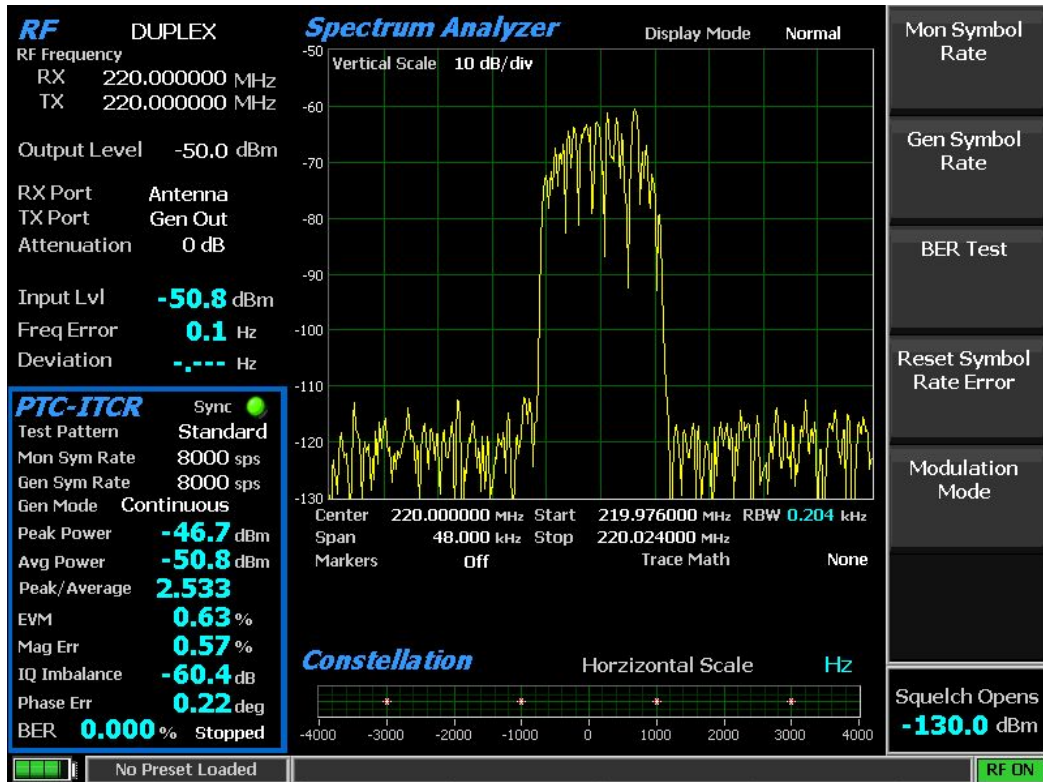

PTC Test in Monitor Mode

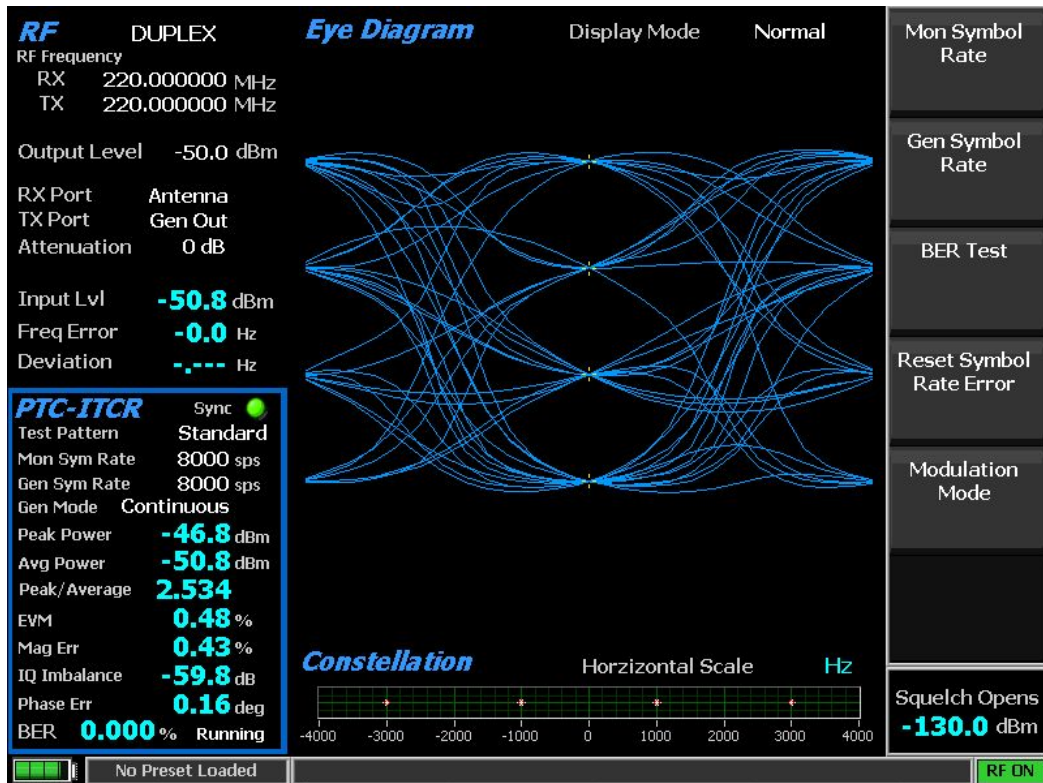

Eye Diagram Display

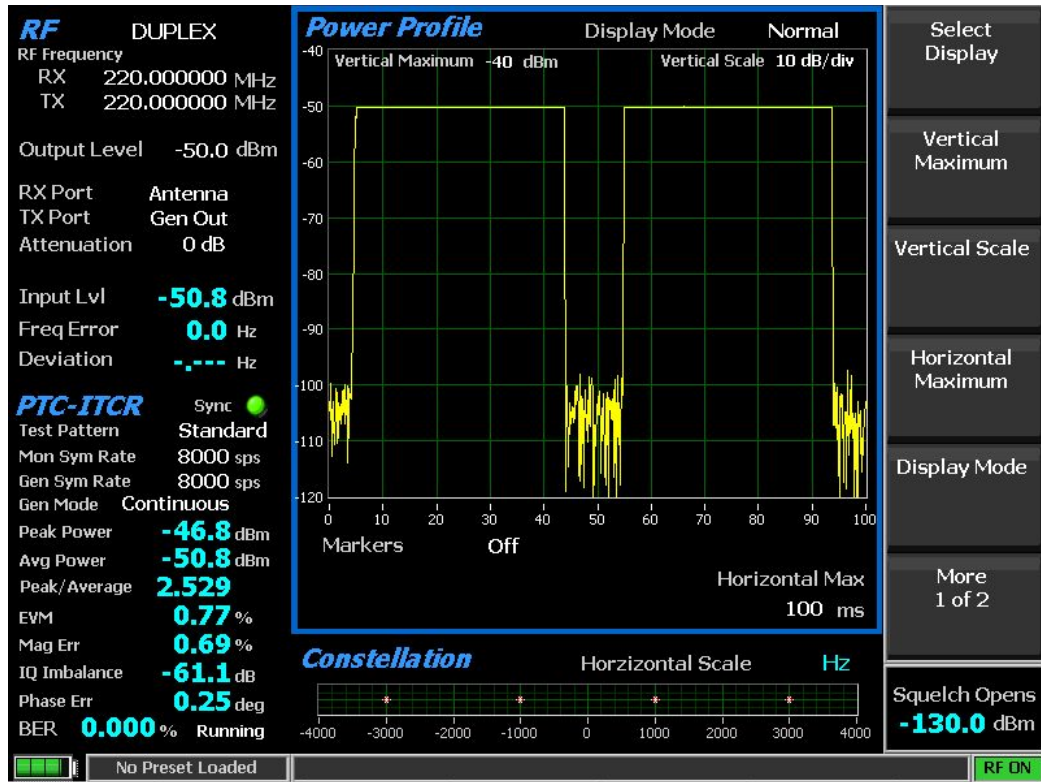

Power Profile Display

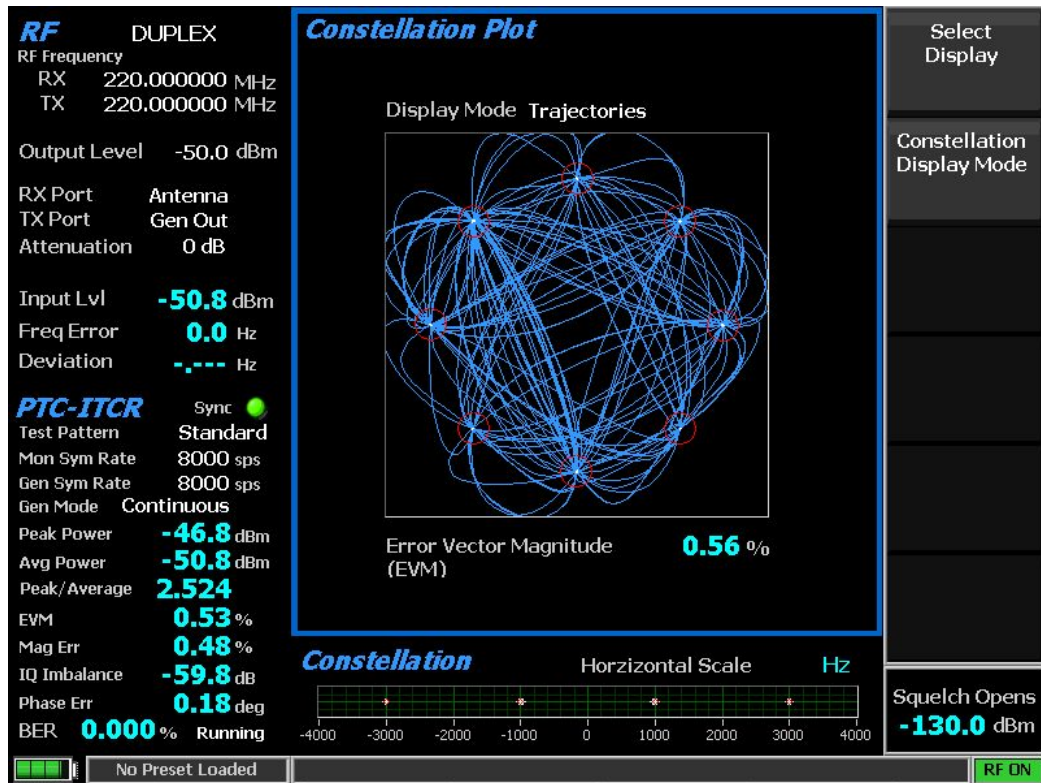

Linear and Circular Constellation Displays

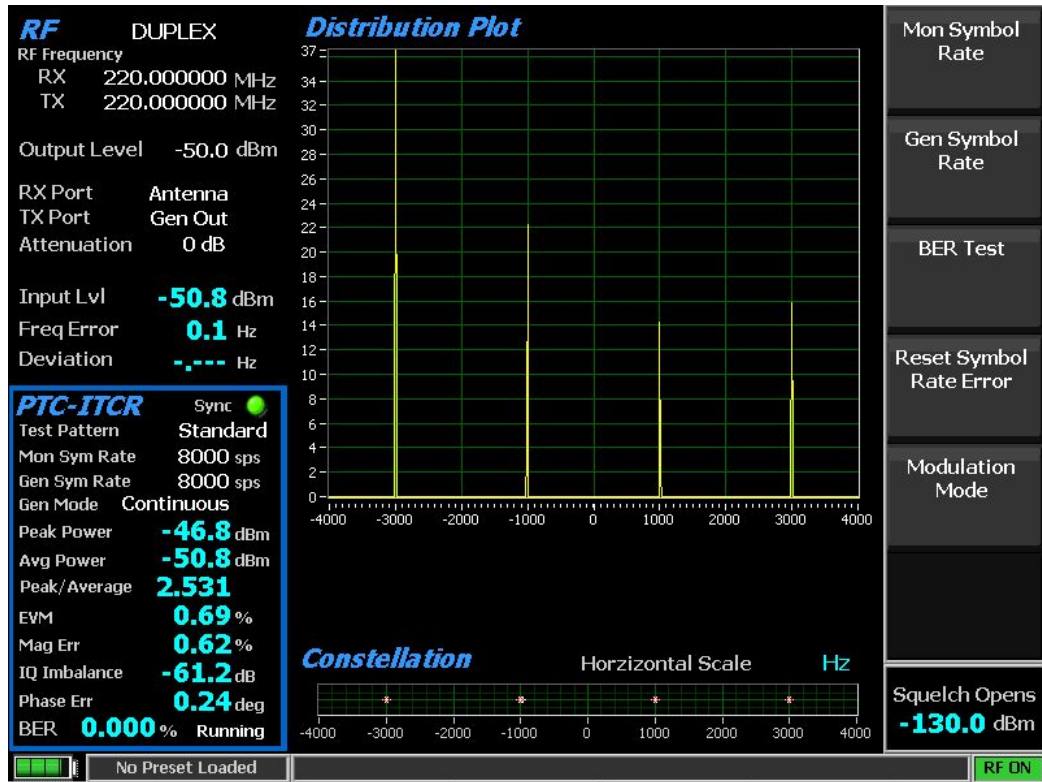

Symbol Distribution Plot

Appendix A – Glossary (List of Abbreviations and Acronyms)

+/-	Plus or minus	Demod	Demodulation
A	Ampere	DHCP	Dynamic Host Configuration Protocol
AC	Alternating Current	Div	Division
ACELP	Algebraic Code-Excited Linear Prediction	DMR	ETSI Digital Mobile Radio
AM	Amplitude Modulation	DNS	Domain Name System/Server
AMBE	DVSI Advanced Multi-Band Excitation	DPL	Digital Private Line, a Motorola registered trademark
APCO	Association of Public-Safety Communications Officials	DQPSK	Differential Quadrature Phase-Shift Keying
APIPA	Automatic Private IP Addressing	DTMF	Dual-tone multi-frequency
AUTO	Automatic	DMO	TETRA Direct Mode Operation (inter-radio)
BER	Bit Error Rate	DMR	ETSI Digital Mobile Radio
BIOS	Basic Input/Output System	DVM	Digital Voltmeter
bps	Bits Per Second	EEA	Electronic Engineering Association
BNC	Coaxial RF Connector	EIA	Electronics Industry Association
BW	Bandwidth	ETSI	European Telecommunications Standards Institute
C	Celsius	FFT	Fast Fourier Transform
C4FM	Continuous 4 Level FM	FM	Frequency Modulation
CAI	Common Air Interface	FREQ	Frequency
CCIR	International Radio Consultative Committee	FSK	Frequency Shift Keying
CCITT	International Telegraph and Telephone Consultative Committee	FTP	File Transfer Protocol
Cm	Centimeters	GHz	Gigahertz
CMOS	Complementary Metal Oxide Semiconductor	HPF	High Pass Filter
CRLF	Carriage-return-line feed	HTTP	Hyper-Text Transfer Protocol
CTCSS	Continuous Tone-Coded Squelch System	Hz	Hertz
CW	Continuous Wave	i.e.	that is to say; in other words
dB	Decibel	I/O	Input and/or Output
dBc	Decibel (referred to carrier)	IC	Integrated Circuit
dBm	Decibel (referred to 1 mW into 50 Ω)	ICMP	Internet Control Message Protocol
DC	Direct Current	ID	Identification
		IEEE	Institute of Electrical and Electronics Engineers

IF	Intermediate Frequency	P25	Project 25
inbound	Tx from mobile into base station	QAM	Quadrature Amplitude Modulation
IP	Internet Protocol	RAN	Radio Access Number
ISI	Inter-Symbol Interference	RBW	Resolution Bandwidth
Kohm	Kilo Ohm	RDCH	RF Direct Traffic Channel
kHz	Kilohertz	REF	Reference
LC	Link Control	RF	Radio Frequency
LCD	Liquid Crystal Display	RMS	Root-Mean-Square
LED	Light-Emitting Diode	RS	Receiver Specification
LPF	Low Pass Filter	RSS	Radio Service Software
Lvl	Level	RTCH	RF Traffic Channel
MAC	Media Access Control	S/N	Signal to Noise
MAX	Maximum	SACCH	Slow Associated Control Channel
MB	Megabytes	SEC	Second
MHz	Megahertz	SEQ	Sequence
MIC	Microphone	SINAD	Ratio of (Signal + Noise + Distortion) / (Noise + Distortion)
MIN	Minimum	SSB	Single Sideband
MNI	TETRA Mobile Network Identity	SSI	TETRA Short Subscriber Identity
ms	Millisecond	STD	Standard
MSB	Most Significant Bit	SW	Switch
mV	Millivolt	Synth	Synthesizer
mW	Milliwatt	TCP	Transmission Control Protocol
n	Number	TDMA	Time Division Multiple Access
N/A	Not Applicable	TETRA	ETSI TERrestrial Trunked RADio
NAC	Network Access Code	TIA	Telecommunications Industry Association
NaN	Not a Number	TMO	TETRA Trunked Mode Operation
NI	National Instruments Corporation	TSBK	Trunking Signaling Block/Data Unit
NVM	Non-volatile memory	TSI	TETRA Subscriber Identity (MNI+SSI)
O.153	ITU O series recommendation	TX	Transmitter
opcode	Operation Code	UHF	Ultra High Frequency
outbound	Tx out of base to mobile station	us	Microsecond
PC	Personal Computer	USB	Universal Serial Bus
PCT	Percent	uV	Microvolt
PL	Private Line, a Motorola registered trademark		

V	Volts
VAC	Volts Alternating Current
VDC	Volts Direct Current
VGA	Video Graphics Array
vocoder	voice encoder / decoder
VRMS	Volts (root-mean-square)
vs.	versus
W	Watts
ZVEI	Zentral-Verband der Elektro-Industrie (a German Electronics Industry Association)

Appendix B – Tone and Code Specifications

Table B-1 Standard DTMF Tones

TONE GROUP	STANDARD DTMF (Hz)
LOW	697
LOW	770
LOW	852
LOW	941
HIGH	1209
HIGH	1336
HIGH	1477
HIGH	1633

Table B-2 DTMF Frequency Coding*

KEY	LOW GROUP TONE (Hz)				HIGH GROUP TONE (Hz)			
	697	770	852	941	1209	1336	1447	1633
1	•				•			
2	•					•		
3	•						•	
A	•							•
4		•			•			
5		•				•		
6		•					•	
B		•						•
7			•		•			
8			•			•		
9			•				•	
C			•					•
*				•	•			
O				•		•		
#				•			•	
D				•				•

*The analyzer has provisions for encoding and decoding 16 different keys. Each key is assigned two frequencies: one from a low tone group and one from a high tone group. Four tones are available from each group, with 16 different combinations of low and high group tones. This table shows the tone assignments of each key.

Table B-3 Private-Line (PL) Codes

CODE	FREQUENCY (Hz)
XZ	67.0
WZ	69.3
XA	71.9
WA	74.4
XB	77.0
WB	79.7
YZ	82.5
YA	85.4
YB	88.5
ZZ	91.5
ZA	94.8
ZB	97.0
1Z	100.0
1A	103.5
1B	107.2
2Z	110.9
2A	114.8
2B	118.8
3Z	123.0
3A	127.3
3B	131.8
4Z	136.5
4A	141.3
4B	146.2
5Z	151.4
5A	156.7
5B	162.2
6Z	167.9
6A	173.8
6B	179.9
7Z	186.2
7A	192.8
M1	203.5
8Z	206.5
M2	210.7
M3	218.1
M4	225.7
9Z	229.1
M5	233.6
M6	241.8
M7	250.3

Table B-4 5/6 Tone Paging Tones

DIGIT	FREQUENCY (HZ)
0	600
1	741
2	882
3	1023
4	1164
5	1305
6	1446
7	1587
8	1728
9	1869
R	459
X	2010

Table B-5 DPL Standard Codes

023	174	445
025	205	464
026	223	465
031	226	466
032	243	503
043	244	506
047	245	516
051	251	532
054	261	546
065	263	565
071	265	606
072	271	612
073	306	624
114	311	627
115	315	631
116	331	632
125	343	654
131	351	662
132	364	664
134	365	703
143	371	712
152	411	723
155	412	731
156	413	732
162	423	734
165	431	743
172	432	

Table B-6 Select V Frequencies

CHARACTER	ZVEI STD (Hz)	ZVEI MOD (Hz)	ZVEI FRENCH (Hz)	CCIR STD (Hz)	CCIR 70MS (Hz)	EEAA (Hz)
0	2400	2200	2400	1981	1981	1981
1	1060	970	1060	1124	1124	1124
2	1160	1060	1160	1197	1197	1197
3	1270	1160	1270	1275	1275	1275
4	1400	1270	1400	1358	1358	1358
5	1530	1400	1530	1446	1446	1446
6	1670	1530	1670	1540	1540	1540
7	1830	1670	1830	1640	1640	1640
8	2000	1830	2000	1747	1747	1747
9	2200	2000	2200	1860	1860	1860
G	2800	885	885	2400	2400	1055
B	810	810	810	930	930	930
C	970	2600	2600	2247	2247	2247
D	885	2800	2800	991	991	991
F	930	930	930	873	873	873
R	2600	2400	970	2110	2110	2110
N _T Tone	0	0	0	0	0	0
Length (ms)	70	70	70	100	70	40

Table B-7 POCSAG Numeric Character Set

Binary	Character
0000	0
0001	1
0010	2
0011	3
0100	4
0101	5
0110	6
0111	7
1000	8
1001	9
1010	Spare (not available)
1011	U
1100	-
1110]
1111	[

Table B-8 POCSAG Alpha-numeric Character Set (7-bit ASCII)

Decimal	Binary	Character	Decimal	Binary	Character	Decimal	Binary	Character
20	0100000	SPACE	52	1000000	@	84	1100000	`

21	0100001	!	53	1000001	A	85	1100001	a
22	0100010	“	54	1000010	B	86	1100010	b
23	0100011	#	55	1000011	C	87	1100011	c
24	0100100	\$	56	1000100	D	88	1100100	d
25	0100101	%	57	1000101	E	89	1100101	e
26	0100110	&	58	1000110	F	90	1100110	f
27	0100111	‘	59	1000111	G	91	1100111	g
28	0101000	(60	1001000	H	92	1101000	h
29	0101001)	61	1001001	I	93	1101001	i
30	0101010	*	62	1001010	J	94	1101010	j
31	0101011	+	63	1001011	K	95	1101011	k
32	0101100	,	64	1001100	L	96	1101100	l
33	0101101	-	65	1001101	M	97	1101101	m
34	0101110	.	66	1001110	N	98	1101110	n
35	0101111	/	67	1001111	O	99	1101111	o
36	0110000	0	68	1010000	P	100	1110000	p
37	0110001	1	69	1010001	Q	101	1110001	q
38	0110010	2	70	1010010	R	102	1110010	r
39	0110011	3	71	1010011	S	103	1110011	s
40	0110100	4	72	1010100	T	104	1110100	t
41	0110101	5	73	1010101	U	105	1110101	u
42	0110110	6	74	1010110	V	106	1110110	v
43	0110111	7	75	1010111	W	107	1110111	w
44	0111000	8	76	1011000	X	108	1111000	x
45	0111001	9	77	1011001	Y	109	1111001	y
46	0111010	:	78	1011010	Z	110	1111010	z
47	0111011	;	79	1011011	[111	1111011	{
48	0111100	<	80	1011100	\	112	1111100	
49	0111101	=	81	1011101]	113	1111101	}
50	0111110	>	82	1011110	^	114	1111110	~
51	0111111	?	83	1011111	_	115	1111111	N/A

Appendix C – R8100 Field Calibration Procedure

The R8100 series Communication Systems Analyzer does not typically require a field calibration once it has left the factory. However, if instructed to do so by Freedom Communication Technologies technical support, a field calibration may be performed. Specific instructions for performing a field calibration will be provided by Freedom Communication Technologies technical support at the time such calibration is needed.

If instructed to perform a field calibration by Freedom Communication Technologies technical support, consider the following performance conditions:

- The field calibration should only be performed in a stable room temperature environment of approximately 70°F.
- To ensure accurate results, place the R8100 in Standard Mode.
- Perform a reset to factory configuration by pressing the front panel Test key followed by Presets..., Load Factory Configuration.
- Operate the unit for at least 30 minutes before continuing.
- Make sure no cables are connected to the front panel. A 50-ohm load is not necessary since the transmit signal is terminated internally.

Note: *The Calibration menu status for both RF Input and RF Output will indicate “Incomplete” during that part of the field calibration. Once each part is finished, the status will be marked “Complete.” This feature is helpful in the event that power to the unit is lost during field calibration. Once power is restored and the Calibration menu is navigated into, an “Incomplete” status will indicate that part of the field calibration did not complete successfully, and the procedure should be rerun.*

